

user manual

pco.edge family



pco.

PCO asks you to carefully read this manual before using the pco.edge camera system and follow the instructions.

In case of any questions or comments, please contact us at PCO.



telephone	+49 (0) 9441 2005 50
fax	+49 (0) 9441 2005 20
email	info@pco.de
postal address	PCO AG Donaupark 11 93309 Kelheim, Germany

The cover photo shows an exemplary pco.edge CLHS camera system. The lens is sold separately.

Copyright © 2016 PCO AG (called PCO in the following text), Kelheim, Germany. All rights reserved. PCO assumes no responsibility for errors or omissions in these materials. These materials are provided as is without warranty of any kind, either expressed or implied, including but not limited to, the implied warranties of merchantability, fitness for a particular purpose, or non-infringement. PCO further does not warrant the accuracy or completeness of the information, text, graphics, links or other items contained within these materials. PCO shall not be liable for any special, indirect, incidental, or consequential damages, including without limitation, lost revenues or lost profits, which may result from the use of these materials. The information is subject to change without notice and does not represent a commitment on the part of PCO in the future. PCO hereby authorizes you to copy documents for non – commercial use within your organization only. In consideration of this authorization, you agree that any copy of these documents, which you make, shall retain all copyright and other proprietary notices contained herein. Each individual document published by PCO may contain other proprietary notices and copyright information relating to that individual document. Nothing contained herein shall be construed as conferring by implication or otherwise any license or right under any patent or trademark of PCO or any third party. Except as expressly provided, above nothing contained herein shall be construed as conferring any license or right under any PCO copyright. Note that any product, process, or technology in this document may be the subject of other intellectual property rights reserved by PCO, and may not be licensed hereunder.

Released: April 2016 © PCO AG

pco.edge family User Manual V2.22 © PCO AG, Germany

TABLE OF CONTENTS

1. INTRODUCTION	5
1.1 INTENDED USE	5
1.2 DATA OVERVIEW	6
2. SAFETY INSTRUCTIONS	7
3. SYSTEM COMPONENTS	8
4. INSTALLATION	9
4.1 DRIVER	9
4.2 CAMWARE	10
5. QUICK START	11
5.1 PREPARATION	11
5.2 START	11
5.3 YOUR FIRST IMAGE	12
6. CAMWARE 4 SOFTWARE	13
6.1 CHAPTER OVERVIEW	13
6.2 CAMERA OVERVIEW / LIST	14
6.3 CAMERA PROPERTIES	15
6.3.1 TIMING	16
6.3.2 ROLLING SHUTTER	19
6.3.3 GLOBAL SHUTTER	23
6.3.4 GLOBAL RESET	26
6.3.5 IMAGE SIZE	28
6.3.6 SENSOR CONTROL	30
6.3.7 RECORDING CONTROL	31
6.3.8 I/O SIGNALS TAB	33
6.3.9 CONVERT CONTROL	35
6.4 IMAGE OVERLAY	37
6.5 RECORDER TOOLS	38
6.6 VIEW WINDOW	39
6.7 RECORDER (IMAGES)	40
6.8 SETTINGS OVERVIEW	41
6.9 CAMWARE TABS & FEATURES	42
6.9.1 DEMO MODE	42
6.9.2 FILE MENU	43
6.9.3 CAMERA MENU	44
6.9.4 ACQUISITION MENU	45
6.9.5 VIEW MENU	46
6.9.6 WINDOW MENU	46
6.9.7 HELP MENU	47
6.9.8 RIGHT-CLICK MENU	47
6.9.9 ADDITIONAL FEATURES	49

APPENDIX	50
A1 TECHNICAL DATA	51
A1.1 STANDARD VERSION	51
A1.2 WATER COOLED STANDARD VERSION	51
A1.3 CAMERA LINK HS VERSION	52
A1.4 SPECIFICATIONS	53
A1.5 MOUNTING	53
A1.5.1 INSTABLE MOUNTING	53
A1.5.2 CORRECT MOUNTING	54
A1.5.3 COOLING	54
A1.6 REVERSE WITH CAPTION	55
A2 CHANGE FROM F-MOUNT TO C-MOUNT	56
A3 WATER COOLING OPTION PCO.AQUAMATIC II	57
A3.1 SYSTEM COMPONENTS	57
A3.2 FIRST TIME INSTALLATION	58
A3.3 OPERATION	59
A3.4 DIMENSIONS	60
A4 INTERFACES	61
A4.1 CABLE POSSIBILITIES	61
A4.2 CAMERA LINK	62
A4.2.1 INSTALLATION OF FRAME GRABBER	62
A4.2.2 MICRO DIAGNOSTICS TOOL	63
A4.2.3 IMAGE DATA FLOW	64
A4.3 CAMERA LINK HS	66
A4.4 USB 3.0	67
A4.4.4 DRIVER INSTALLATION	67
A4.4.5 HARDWARE RECOMMENDATIONS	67
A4.4.6 USB 3.0 FAQ	69
A4.4.7 INSTALLATION OF THE USB 3.0 CARD	71
A4.4.8 RING BUFFER AND FIFO	72
A5 BINNING WITH CMOS SENSORS	73
A6 LIGHTSHEET SCANNING MODE	74
A7 IMAGE FILE FORMATS	75
A8 CUSTOMER SERVICE	77
A8.1 SERVICE	77
A8.2 MAINTENANCE	77
A8.3 RECYCLING	77
A8.4 TROUBLE SHOOTING	78
A9 INDEX	79
ABOUT PCO	80

1. INTRODUCTION



Advantages of the pco.edge family

The pco.edge family is a breakthrough in scientific imaging cameras. It has the distinctive ability to simultaneously deliver extremely low noise, high frame rates, wide dynamic range, high quantum efficiency, high resolution and a large field of view - all in one image.

The camera's main features (model-specific)

- **ultra low noise** down to 0.8 electrons med
- **high resolution** up to 5.5 megapixel
- **best dynamic range** up to 40000:1
- **high-speed** up to 100 fps @ full resolution
- **high quantum efficiency** up to 80%
- **flexibility** user selectable choice of shutter mode
- **free of drift** stabilized Peltier cooling in order to avoid any drift phenomena in image sequences

1.1 INTENDED USE

This camera system is designed for use by technicians, engineers and scientists. It is a scientific measuring instrument, which provides images. The camera may only be used according to the instructions of this manual. The disclosures and operating conditions in these operating instructions must be respected. Unauthorized modifications and changes of the device are forbidden for safety reasons.

Areas of Application

- live cell microscopy
- single molecule detection
- localization microscopy
- lightsheet microscopy
- selective plane illumination microscopy
- SPIM
- structured illumination microscopy
- SIM
- TIRF microscopy / waveguides
- spinning disk confocal microscopy
- genome sequencing (2nd and 3rd gen)
- FRET
- FRAP
- lucky imaging astronomy
- adaptive optics
- solar astronomy
- fluorescence spectroscopy
- bio- & chemiluminescence
- high content screening
- photovoltaic inspection
- x-ray tomography
- ophthalmology
- flow cytometry
- biochip reading
- machine vision
- spectral (hyperspectral) imaging
- laser induced breakdown-spectroscopy (LIBS)

1.2 DATA OVERVIEW

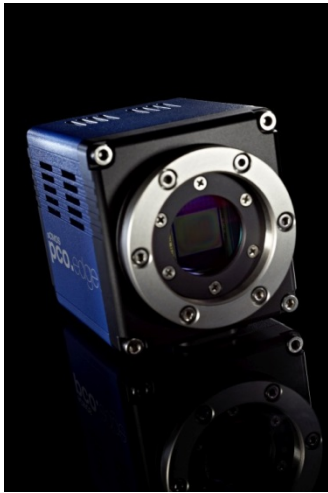

Overview – Available camera models

This table shows an overview over all available camera models.

Type	Inter- face	Shutter	Read Out Frequency	Line time (μ s)	FPS	Sensor
pco.edge 3.1	USB 3.0	Rolling	105 MHz	24.93	50	mono & color
		Global	204 MHz	12.80	48	
		Global Reset	105 MHz	24.99	50	
pco.edge 4.2 LT	USB 3.0	Rolling	110 MHz	24.10	40	mono
		Global Reset	110 MHz	24.10	40	
pco.edge 4.2	USB 3.0	Rolling	110 MHz	24.10	40	mono
		Global Reset	110 MHz	24.10	40	
pco.edge 4.2	Camera Link	Rolling	95.3 MHz (slow scan)	27.60	35	mono
			272.3 MHz (fast scan)	9.65	100	
pco.edge 4.2	Camera Link HS	Rolling	100 MHz	26.50	36	mono
			274 MHz	9.68	101	
pco.edge 5.5	USB 3.0	Rolling	86 MHz	30.5	30	mono & color
		Global	160 MHz	16.40	28	
		Global Reset	86 MHz	30.51	30	
pco.edge 5.5	Camera Link	Rolling	95.3 MHz (slow scan)	27.52	33	mono & color
			286 MHz (fast scan)	9.17	100	
		Global	286 MHz	9.17	50	
		Global Reset	95.3 MHz (slow scan)	27.52	33	
286 MHz (fast scan)	9.17		100			
pco.edge 5.5	Camera Link HS	Rolling	100 MHz (slow scan)	26.24	35	mono & color
			286 MHz (fast scan)	9.17	100	
		Global	286 MHz	9.17	50	
		Global Reset	100 MHz (slow scan)	26.24	34	
286 MHz (fast scan)	9.17		95			

2. SAFETY INSTRUCTIONS



CLASS 1 LASER PRODUCT (only pco.edge CLHS)

Risk of injury due to dazzle.

- Do not point the laser beam at persons.
- Do not look into the laser beam or at direct reflexes.
- Manipulations of the laser device are not allowed.



DANGER

DAMAGED POWER CABLE OR POWER PLUG

Danger to life due to electric shock.

- Each time the camera is used, check the power cable for damage.



WARNING

ELECTRIC SHOCK WARNING DUE TO VOLTAGE PARTS INSIDE

Risk of injury due to electric shock.

- Never slide any items through slits or holes into the camera.



CAUTION

CONDENSATION

Risk of injury due to electric shock if condensation enters the camera.

- To avoid the risk of water condensation, protect the camera against extreme changes of ambient temperature.



CAUTION

TRIPPING HAZARD

Risk of injury from tripping over loose cables.

- Never position the cable in a way that it could become a tripping hazard.

NOTICE

HUMID OR DUSTY ENVIRONMENTS

Humidity, dust or X-rays could damage the camera.

- Never operate the camera in humid or dusty environments or in places with high amounts of X-ray radiation.

NOTICE

JOLT & VIBRATION

To prevent damage to the camera, the system must be kept stable and protected against strong jolts or vibrations.

- Use the mounting threads of the camera to mount the camera stable.

NOTICE

LENS MOUNTING

Do not force the lens onto the camera.

- To protect the lens connector thread from damage, use minimal force when attaching a lens to the camera.

NOTICE

LIQUIDS DAMAGE CAMERA

If liquids have penetrated the device.

- Immediately switch off the camera, separate it from power line and contact our customer support.

NOTICE

DAMAGED CAMERA HOUSING

If the camera has been dropped or the casing is damaged.

- Immediately switch off the camera, separate it from power line and contact our customer support.

3. SYSTEM COMPONENTS



The camera system includes the following parts.

Camera Head

F-mount optical connection (standard)
For standard F-mount / SLR lenses and adapters.

C-mount ring provided (see appendix **A2**)
For standard C-mount and microscopy connectors.



DC Power Jack (connect to power supply)

Input/Output 4x SMA connectors 2x input - 2x output

Interface (user selectable)

LED indicates camera status

Green continuous: camera is booting

Green blinking: camera is ready for operation

Yellow blinking: recording on

Red blinking: error



pco.edge 5,5 m
rolling shutter
SN: 61000016

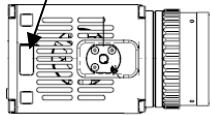

Serial Number Tag (on the bottom of the camera)

Mounting Thread

1/4-20 UNC mounting thread



Camera Link Grabber Card / USB 3.0 PCI Interface Card

PCI Express x4 Card (Camera Link **full or CLHS**) or
PCI Express x1 Card (2 x USB 3.0 connections)

A PCI Card with 4 x USB 3.0 connections is also available, contact PCO for further details. A PCIe x4 slot is necessary for this card.



Power Supply

Your system will be equipped with either a 24 V or a 12 V power supply, depending on the model you selected. (connector: Lemo FGG.0B)



Cable

CameraLink Cable (2x3m) / USB-A/USB-B cable (5m) / FOL cable



Digital Camera Tools (USB storage device content)

- Camware: software for camera control & image acquisition
- Camera driver & tools
- Software development kit (SDK) & demo programs in C and C++

4. INSTALLATION

You will find all necessary files on the accompanying USB storage device. You may also download the latest versions of our software, camera driver and third party software drivers from the PCO website.

Minimum system requirements:

- Intel® Core™ i7
- RAM > 8 GB DDR3
- Windows 7 or higher
- Full-HD resolution display
- PCI Express x4 Gen 2 (CLHS)
- PCI Express x4 Gen 1 (CL)

Please contact PCO for an appropriate system configuration.

4.1 DRIVER

There are three different kinds of interfaces available:

Camera Link & Camera Link HS(Frame Grabber)

When operating the camera with **Camera Link Interface**: Please run the appropriate grabber driver installation with default settings.

For **detailed installation instructions** please see **A4** (frame grabber card instruction).

USB 3.0

When **USB 3.0** is used as a camera interface, it is recommended to use the enclosed **PCI Interface card**. For **detailed installation instructions** or further hardware recommendations, see **A4.3**.

NVIDIA Cuda Driver: (only pco.edge color cameras)

Please update your NVIDIA driver for Camware 4. In case of an old driver version **GPU Processing** is not working. Therefore image processing is slow.

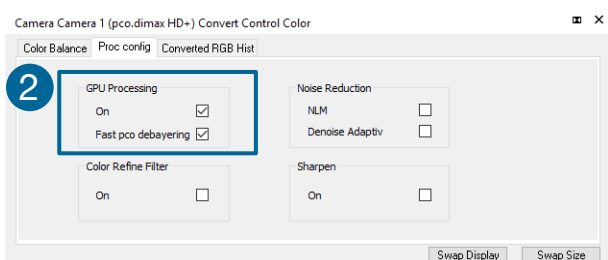
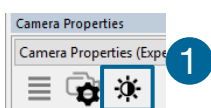

Please check if **GPU Processing** is activated by having a look into the **Proc config settings** **2** in the **Convert Control window** **1** (see Convert Control chapter **6.3.9**).

If **GPU Processing** is disabled and shown grayed, please update your NVIDIA driver or check the website of the computer manufacturer for graphic card driver updates. Your NVIDIA driver version must be at least **333.11** or above.

4.2 CAMWARE

The **Camware** Windows application software enables you to control every camera parameter or setting. Images can be displayed on a monitor and may be downloaded and stored. The USB storage device contains the installation files for the software for latest Windows operating systems in 32 & 64 bit.

After a successful installation, you will find the program folder **Digital Camera Toolbox** in your program directory and a **Camware32/64 button** on your desktop. Other helpful tools are also installed in the same directory.

To uninstall the Camware program, please use the Software feature under Windows' System Control.

Please follow the installation wizard

- 1 Install Camware as Admin to install to program folder, instead it will be installed only to user folder
- 2 Then choose install directory
- 3 Choose components: Select additional drivers for Camera Link Interface (Silicon Software DII mE IV)
- 4 After the next two screens installation is complete

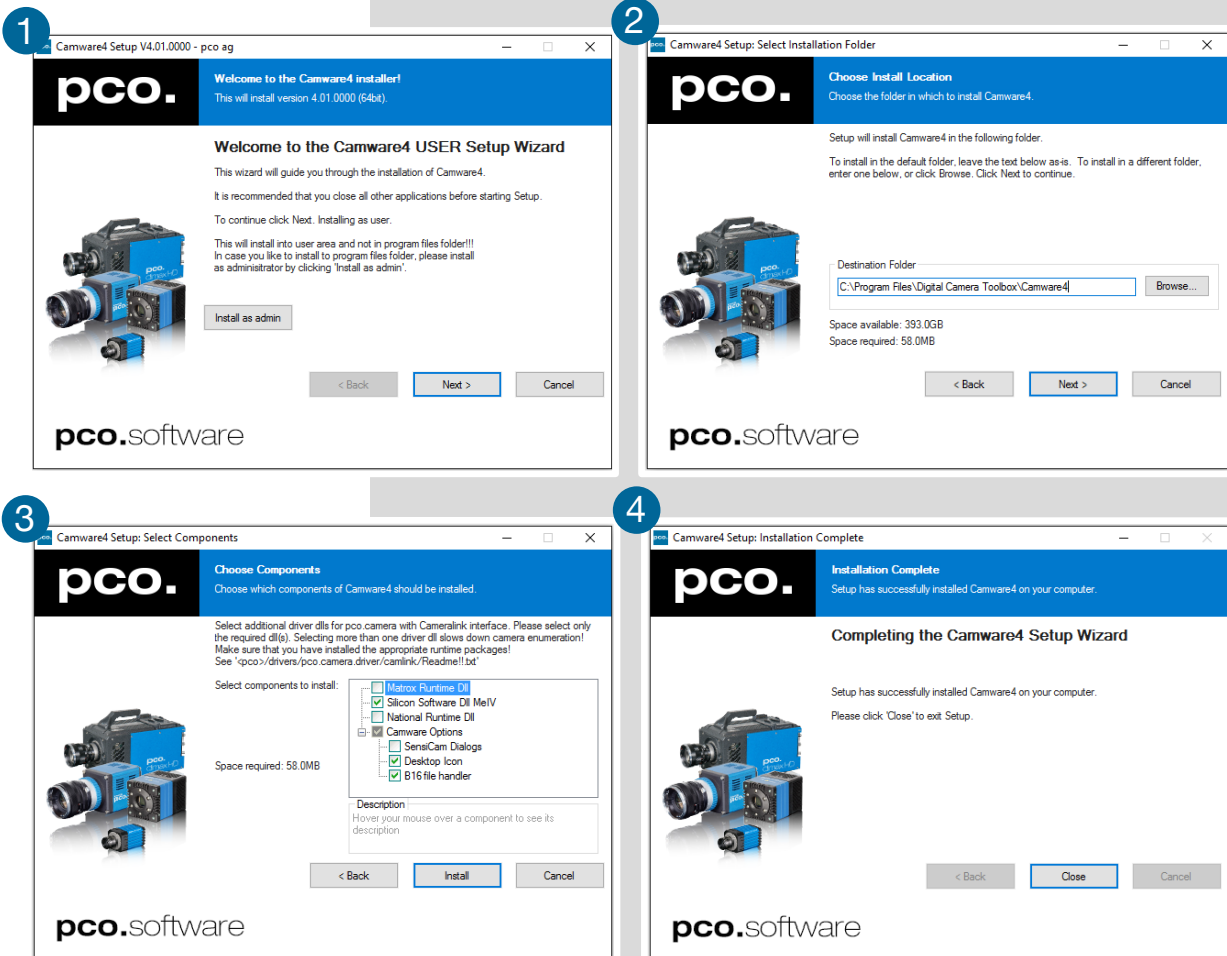

5. QUICK START

In order to get familiar with your new camera and software it might be helpful, if you first aim at an object that is easy to focus and that can be seen at standard light conditions.

5.1 PREPARATION

- **Computer** is turned on
- **Installation** is finished (see chapter 4)
- **An appropriate lens** is attached (remove cap) or the camera is attached properly to the microscope, spectrograph or other scientific device
- **Camera** is connected to the PC (USB 3.0 or Camera Link)
- **Camera** is connected to the power supply and ready (green LED blinks)

5.2 START



Start **Camware** and the **graphical user interface** will start up:

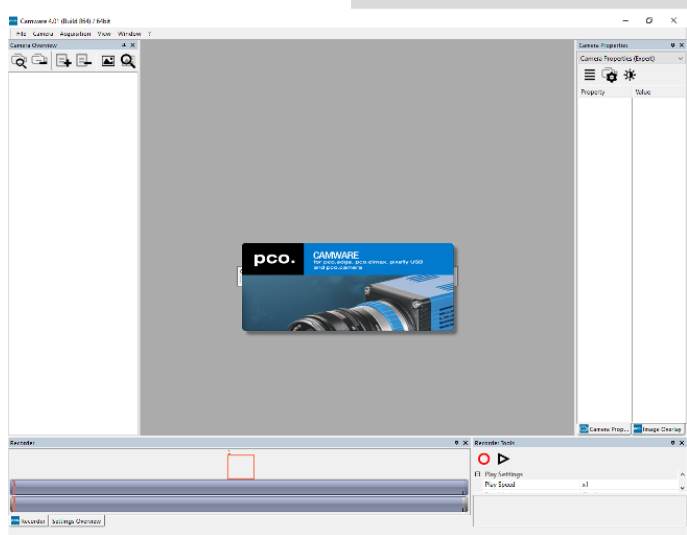

NOTE

Always install latest Camware version to be able to use full function of your pco camera.

5.3 YOUR FIRST IMAGE

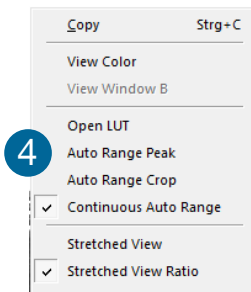
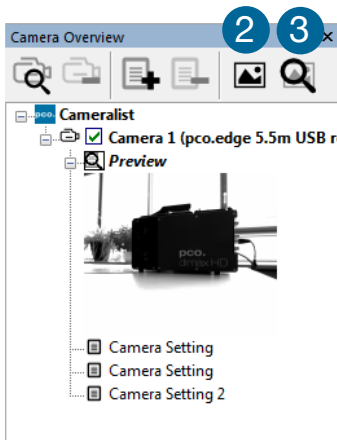

Please follow the instructions:



- **Camware** must be started. 1
- A view window 2 is shown automatically /or open a new one.
- Start **live preview**. 3
- Right-click in the view window and apply **Auto Range Peak**. 4
- You may adjust **exposure time** 5 , **aperture** and **focus**.
- Now you should clearly 6 see the **object** in the window.

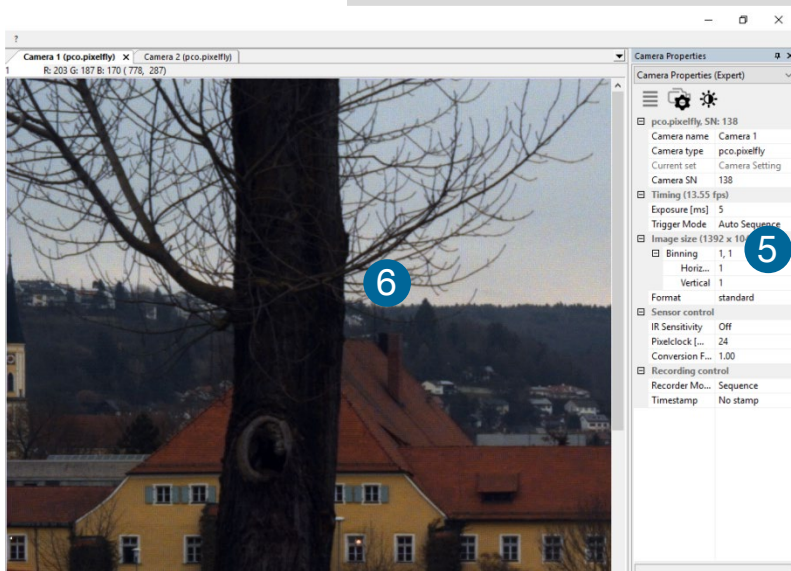

If you need to change **exposure** time (e.g. the image is still either too dark or too bright), please go to chapter 6.3.2.

If you want to record and save images, please see chapter 6.3.7 and chapter 6.6 for detailed information.

NOTE

Live preview: Useful for fast and easy camera adjustment and focusing. Does not record or store images.

6. CAMWARE 4 SOFTWARE



PCO's Camware is an excellent software for camera control, image acquisition and archiving of images in various file formats. This chapter provides a detailed description of all Camware functions.

Camware works with any kind of PCO camera. Please see **PCO website** for the latest version of this software.

6.1 CHAPTER OVERVIEW

Chapter 6.2: lists all cameras connected

6.2 Camera Overview/List	Preview, connected cameras, recording profiles
---------------------------------	--

Chapter 6.3 Camera Properties: main dialog for all camera settings:

6.3.1 Timing	Timing settings / Trigger modes / Synchronization
6.3.2 Rolling Shutter	Explanation / Timing
6.3.3 Global Shutter	Explanation / Timing
6.3.4 Global Reset	Explanation / Timing
6.3.5 Image Size	ROI / Sensor format / Binning
6.3.6 Sensor Control	CDI / Double shutter / Temperature
6.3.7 Recording Control	Recorder acquire mode / Timestamp / Sequence trigger
6.3.8 I/O Signals	Input - Output
6.3.9 Convert Control Dialog	Contrast, Saturation, Gamma...

Chapter 6.4/ 6.5 /6.6 /6.7 / 6.8 describe the recording functions

6.4 Image Overlay	Overlay for recorded images
6.5 Recorder Tools	Record / Play and Settings
6.6 View Window	View window functions
6.7 Recorder (Images)	Preview of recorded images
6.8 Settings Overview	Overview of all property settings

Chapter 6.7 describes the available tabs (File, Camera Acquisition, View, Window, Help) the right-click menu and additional features.

6.9.1 Demo Mode	No camera connected
6.9.2 File	Open, save and print files
6.9.3 Camera	Camera control; Rescan, Setup...
6.9.4 Acquisition	Live preview; Acquire sequence; Rec. memory settings; Rec. settings
6.9.5 View	New window; Convert Control
6.9.6 Window	New / close / split window
6.9.7 Help	Logfiles, Support file, About
6.9.8 Right-click menu	Zoom; Flip; Mirror; Rotate...
6.9.9 Additional features	White Balance, Contrast, ROI by Mouse, Short Cut list

6.2 CAMERA OVERVIEW / LIST

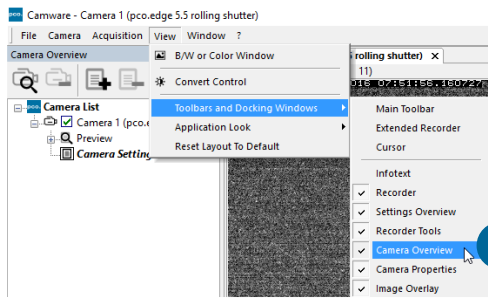

If closed, the **Camera Overview** window can be opened by selecting the **View** tab and **Toolbars and Docking Windows** → **Camera Overview**. ①

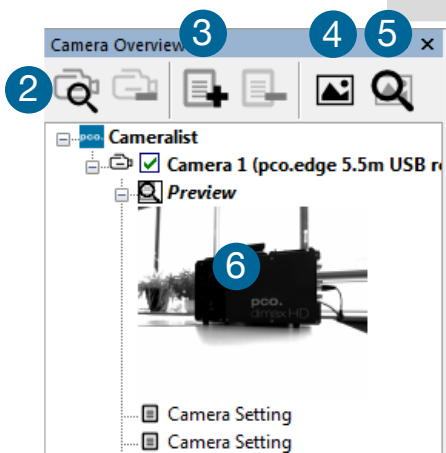

The **Camera Overview** window allows you to manage several connected cameras. It displays a list of all connected PCO cameras. Camware is able to **scan** ② for connected cameras or close a connected camera. It is possible to define many different **settings** for each camera (max. 30 sets per camera → **add new set** ③). Settings can be switched easily, at any time and copied to other cameras. **New view windows** ④ can be opened and the **Live Preview** ⑤ can be started. When unfolded **Preview** shows a **small preview window** ⑥ (always monochrome) integrated to the camera list.

Live preview gives the ability to adjust aperture and focus and to have a first look at your object.

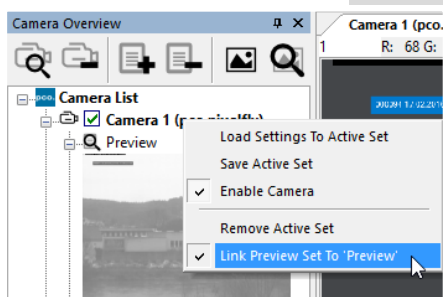

Link Preview Set to 'Preview'

When **Link Preview Set to Preview** is activated the Preview set with its parameters will always be active when you start a **Live Preview** ⑤.

In case this function is deactivated the **Live Preview** will always show live images with the parameters of your active setting.

Setting a higher exposure time for **Preview** set and linking it to the preview function can be a great advantage if preview light conditions are different from those in recording situations.

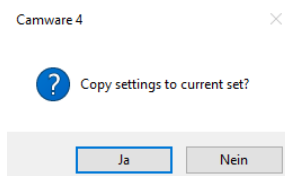

Click and drag camera setting: If you want to copy e.g. **Camera Setting 1** to **Camera Setting 4** just drag & drop **Setting 1** to **Setting 4** and Camware will ask you if you want to copy the settings. It is possible to copy each setting to every camera.

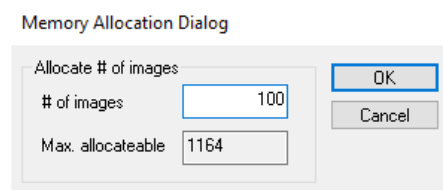

Important Setting (for cameras without internal memory)

Memory Allocation Dialog

If you want to change the **number of recorded images** in Camware, you have to open the **Acquisition Tab** (see 6.9.4) and choose **Recorder Memory Settings**.

This sets the number of images recorded in one sequence. The maximum is defined by approved RAM size.

6.3 CAMERA PROPERTIES

The **Camera Properties** window in Camware is the main interface for all camera settings. The active set selected within Camera List can be adjusted here.

The former main instance **Camera Control** (known from Camware 3.x) and the **Convert Control** (see 6.3.9) can be opened additionally.

Three view options with various functions can be selected: **Standard**, **Custom** and **Expert**.

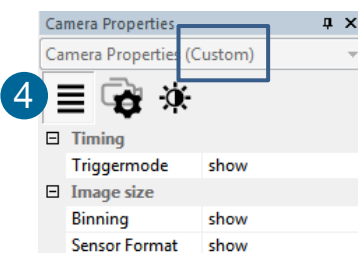
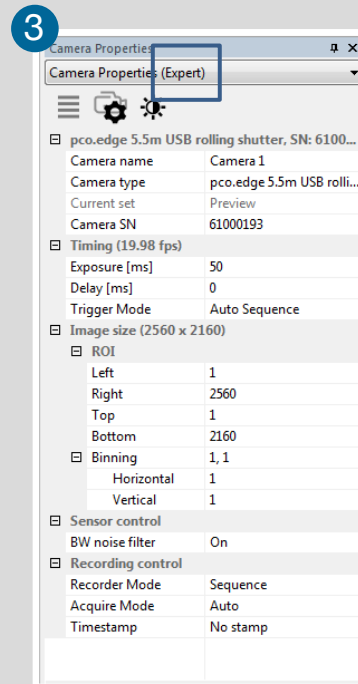
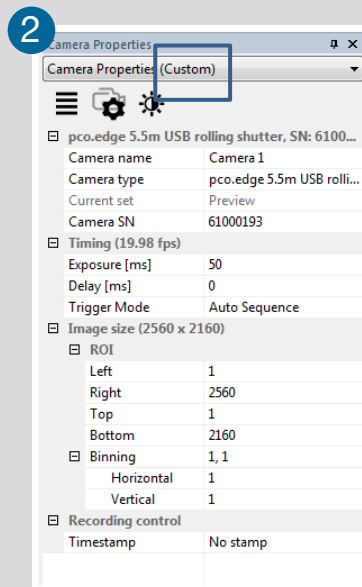
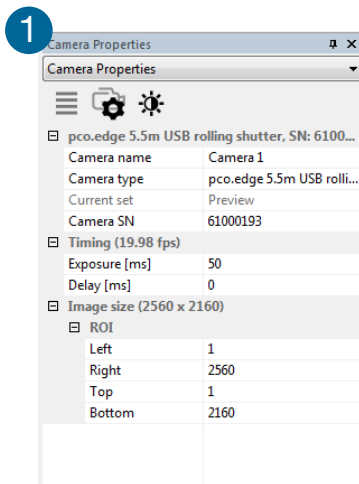

Standard mode ① only shows camera name, type, set and serial number and the exposure time. It is recommended for new Camware users.

Custom mode ② shows several more setting possibilities and can be configured individually by the **Custom Properties Button**. ④ Additional to the standard mode Trigger mode, Image Size and Recording control options are selectable.

Expert mode ③ (for advanced users) shows all possible camera property settings.

An **explanation** for every setting is displayed below the properties dialog.

Exposure [ms]
Specifies the exposure time

6.3.1 TIMING

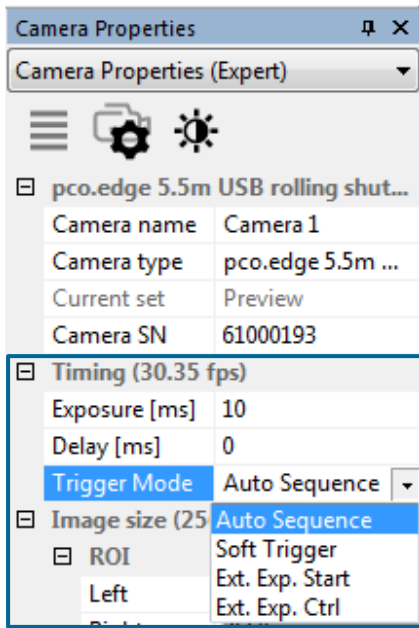

Introduction to timing

An important parameter for a camera is the frame rate. The upper limit of the frame rate is defined by exposure and readout time.

The figure below shows the timing scheme. Exposure and readout are done simultaneously, this means while image n is readout from the sensor, image $n+1$ is already integrated within the sensor's pixel elements.

Figure 1 shows, that in case of short exposure times, the readout is the limiting factor. The second figure 2 shows that for long exposure times the exposure time plus delay (t_{delay}) is the limiting factor.

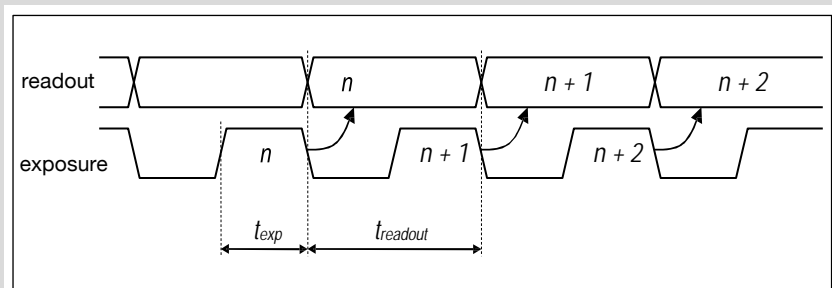

Figure 1: Image timing for short exposure times

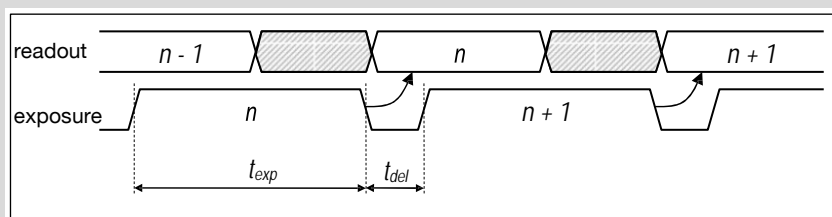
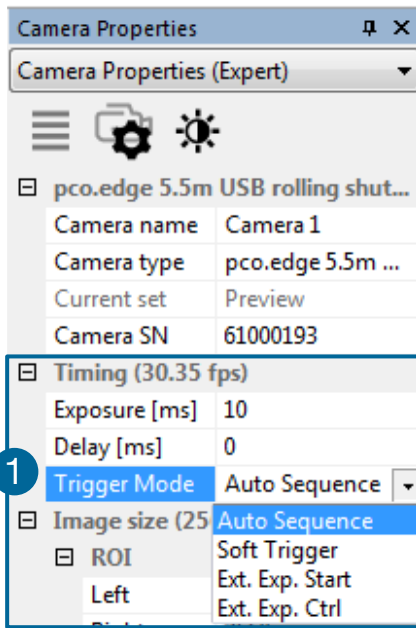

Figure 2: Image timing for long exposure times

If a lower frame rate is desired, this can be achieved by inserting additional delay times. These rules also apply in external trigger mode, i. e. this defines when the next trigger can be applied or recognized.

For further timing explanations (e.g. fps based timing) please read the following chapters for Rolling Shutter, Global Shutter and Global Reset.

**NOTE**

If the trigger rate of the external signal is quite near the maximum possible frame rate (difference < 1/1000), it will be random, whether or not a trigger is accepted!

Trigger Mode 1

In this context trigger means exposure trigger, i.e. the trigger signal controls the exposure of a single image (light integration time).

Auto Sequence: The camera will optimize the image recording to achieve the best possible frame rate.

In the auto sequence exposure control mode, the camera determines the fastest possible frame rate depending on the adjusted exposure time and the required readout time.

After a start command is given, the sequential recording is started until a stop command is given.

Soft Trigger: Single images can be recorded with this Camware command. A single image can be acquired by pressing the **Single Trigger** button. This button appears after pressing the **Start Record** button (see 6.5). Other signals cannot influence this operating mode.

In the **External Exposure Start** exposure control mode, single image recording is started by the falling or rising edge of the voltage signal at the SMA input #1(see 6.3.8). The frame rate cannot be set, as the frame rate is defined by the frequency of the external signal. However the predefined exposure time and ROI settings affect the maximum possible frame rate.

The **Busy Status** signal at SMA #3 (SMA explanation see 6.3.8) will indicate whether a new trigger is accepted.

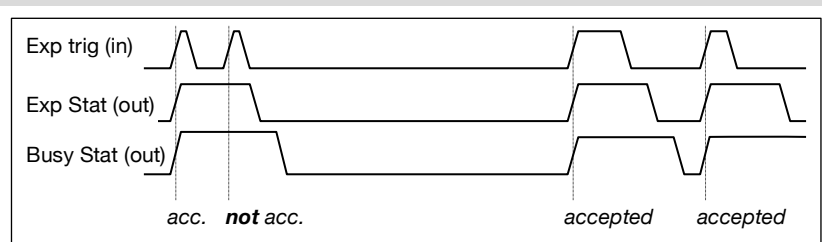

The maximum achievable frame rate in external trigger mode is negligibly less (about 0.1%) than operating the camera in **Auto Sequence** mode.

If the trigger rate of the external signal is higher than the maximum possible frame rate, every second trigger pulse is ignored. Therefore the actual frame rate drops to half of the external trigger rate. If the trigger rate is increased further, then only every third, every fourth etc. trigger edge will be accepted.

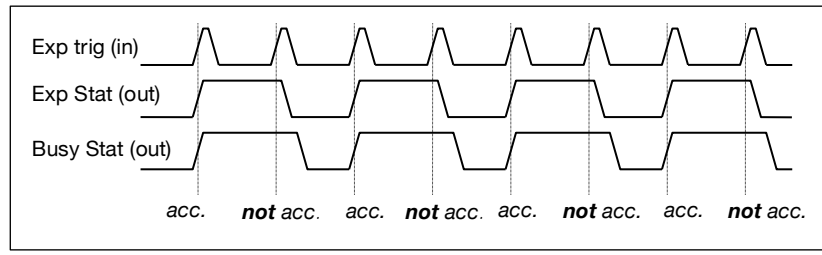

In order to avoid trade-offs at maximum frame rate use either the **Busy Status** signal or make sure that the external trigger rate follows this condition: $0.999 \times \text{External Trigger Rate} \leq f_{\text{max}}$.

External Exp. Control An external signal applied at SMA #1 (see 6.3.8), controls the **start** and the **duration** of the exposure.

A new exposure is started by the falling or rising edge of the voltage signal at the SMA input. The exposure is finished when the opposite edge is detected. Thus in this mode, the start as well as the length of the exposure time can be controlled.

No further settings can be made, as the image timing is completely controlled by the external trigger signal.

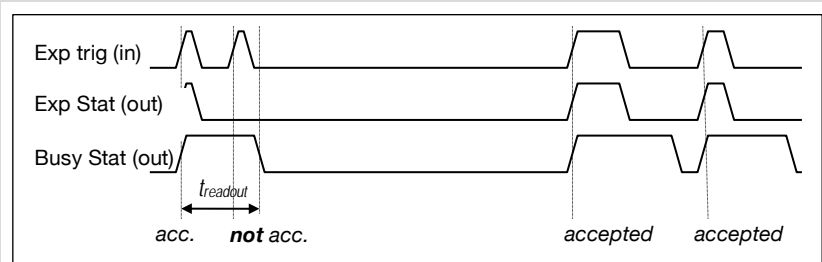

Be aware, that the externally controlled exposure time is limited. The integration will be stopped automatically if the maximum exposure time is achieved.

The Busy Status signal at SMA #3 (see 6.3.8) indicates if a new trigger is accepted.

Camera	Interface	Shutter Mode	Max. exposure time
pco.edge 3.1	USB 3.0	Rolling	2 s
		Global	100 ms
		Global Reset	2 s
pco.edge 4.2LT	USB 3.0	Rolling	10 s
		Global Reset	2s
pco.edge 4.2	CL / CLHS	Rolling	10 s
pco.edge 4.2	USB 3.0	Rolling	20 s
		Global Reset	2 s
pco.edge 5.5	CL / CLHS	Rolling	2 s
		Global	100 ms
		Global Reset	2 s
pco.edge 5.5	USB 3.0	Rolling	2 s
		Global	100 ms
		Global Reset	2 s

6.3.2 ROLLING SHUTTER

In **Rolling Shutter** mode the pixel reset and exposure start is carried out row by row. Each row has the same exposure time, but a different start and end of exposure. The pco.edge image sensor consists of two discrete halves, which are exposed and read out simultaneously, i.e. from the outside to the center by default. Within one row, the exposure starts simultaneously for all pixels. Available **RS** readout modes see chapter 6.9.3.

General Timing Diagram

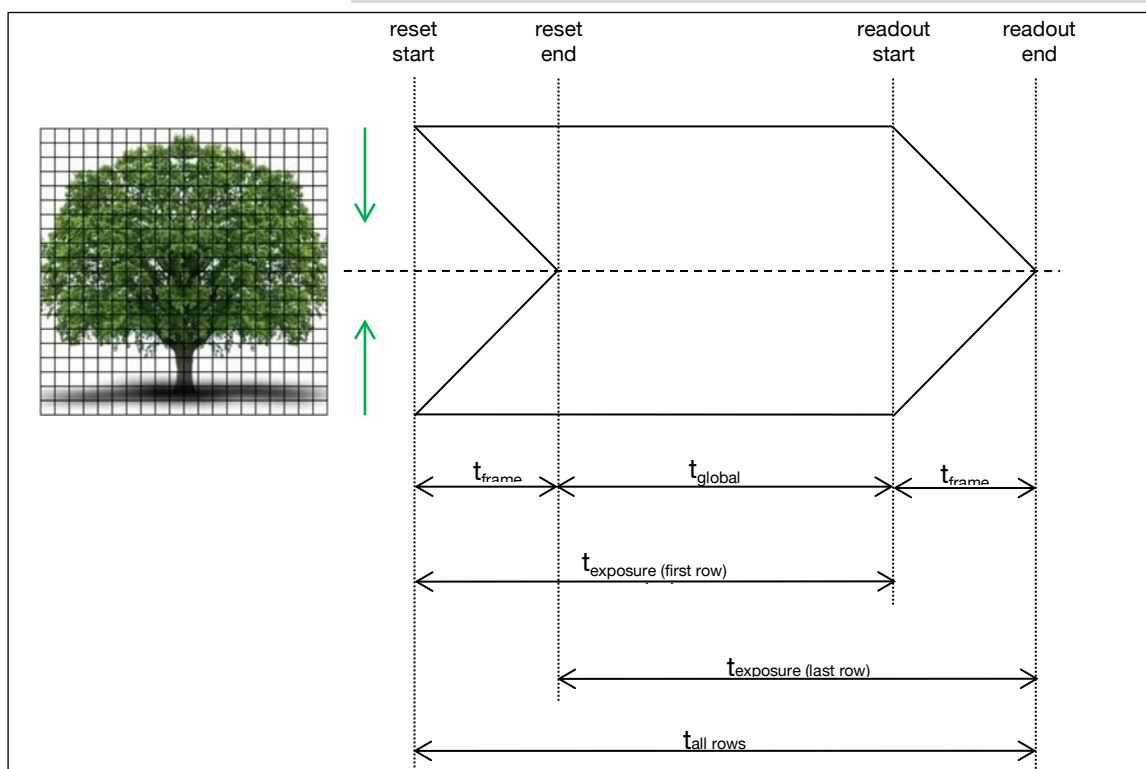

The exposure time of each row starts with the corresponding reset of the row. Then after a predefined time, the exposure is stopped. The light induced accumulated charge carriers of the pixels in a row are recorded into memory in a low noise (readout) mode. This results in the total image appearing in memory corresponding to the row readout.

Timing

The exposure and delay time can be adjusted in steps of one line time (see p.6).

Camera Properties	
Camera Properties (Expert)	
pco.edge 5.5 rolling shutter, SN: 73	
Camera name	Camera 1
Camera type	pco.edge 5.5 roll...
Current set	Camera Setting
Camera SN	73
Timing (100.92 fps)	
Exposure [us]	500
Delay [ms]	0
FPS based	Off
Trigger Mode	Auto Sequence

Camera (RS only)	Interface	Exposure time	Delay time
pco.edge 3.1	USB 3.0	500 μ s ... 2 s	0 ... 1 s
pco.edge 4.2 LT	USB 3.0	100 μ s ... 10 s	
pco.edge 4.2	Camera Link & CLHS	100 μ s ... 10 s	
pco.edge 4.2	USB 3.0	100 μ s ... 20 s	
pco.edge 5.5	CL & CLHS & USB 3.0	500 μ s ... 2 s	

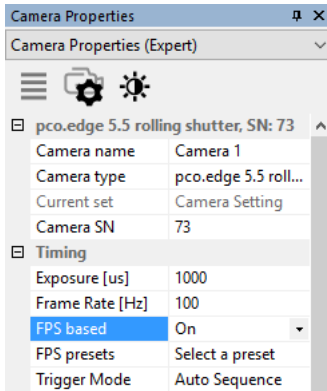

FPS based (only Camera Link interface)

The camera will optimize the image recording to achieve the selected frame rate with chosen exposure time as close as possible.

Only for **Auto Sequence** trigger mode **and** only available with **Camera Link** Interface

First the frame rate is set. If the time required for readout of the image is longer than $1 / \text{frame rate}$, then the frame rate will be reduced to $1 / t_{\text{readout}}$.

The frame rate can be adjusted in steps of 1 mHz (Rolling Shutter). If the selected exposure time would require a lower frame rate, the exposure time is cut to the maximum possible time at that frame rate.

Camera	Interface	Frame rate (FPS Based)	Exposure time
pco.edge 4.2 (@ full resol.)	CL	0.1...35 Hz @ 95.3 MHz	100 μ s...10 s
		0.1...100 Hz @ 272.3 MHz	
pco.edge 5.5 (@ full resol.)	CL	0.1...100 Hz @ 272.3 MHz	500 μ s...2 s
		0.5...100 Hz @ 286 MHz	

Exposure time > Sensor frame readout time (Auto Sequence)

In case the required exposure time is longer than the frame readout time, the image sensor is completely exposed to light for some time (t_{global}). In case of a triggered flash illumination, this would be the best moment to illuminate the image sensor.

NOTE
 $\Delta t = t$: 1 line time
 (See p.6)

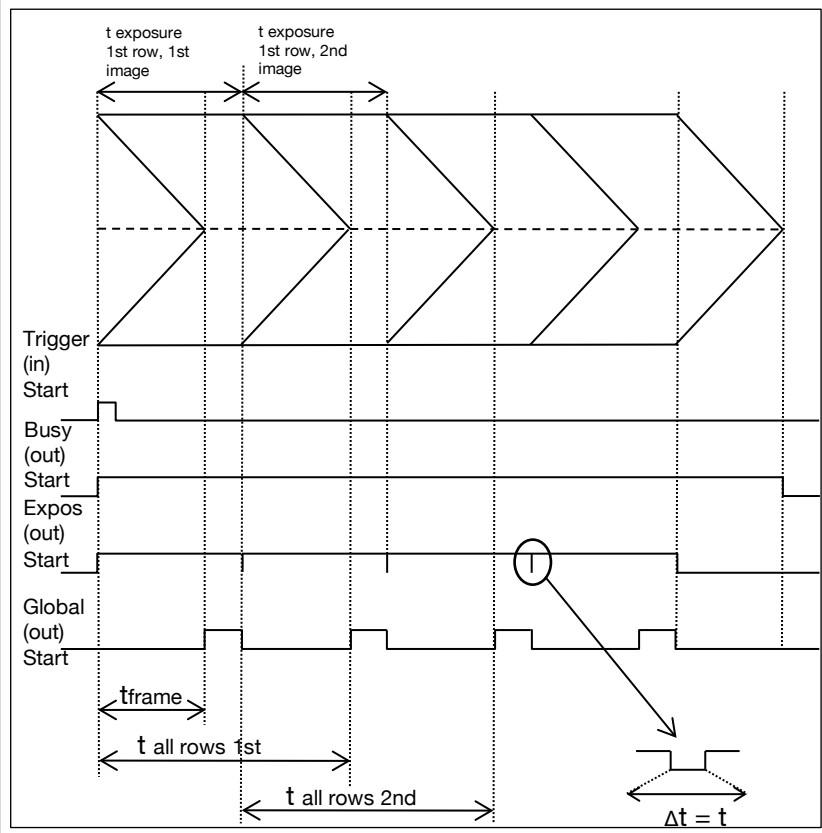

The hardware signal for the time t_{global} is available on **connector #4** (Global out see **6.3.8**).

Obviously, if during exposure and readout, parts of the viewed image are moving horizontally, this would result in image distortion. This is why the global shutter mode may be a prerequisite for some applications.

However, most dynamic events can be captured in 1 ms, which is a common integration time with SLR cameras set at 1/1000 exposure. The time shift from one row to another is only about 10 μs (fast scan). The resulting maximum readout time of 10 ms (at full resolution) seems to be sufficient for a broad spectrum of dynamic events.

The 10 ms is also faster than the image shift process of most frame transfer **emCCD** image sensors previously used for low light applications. If this does not influence the image recording and processing, then rolling shutter mode will not affect it either.

Exposure time < Sensor frame readout time (Auto Sequence)

In case the required exposure time is shorter than the frame readout time, the image is composed of two exposure bands moving from the outside to the center of the sensor.

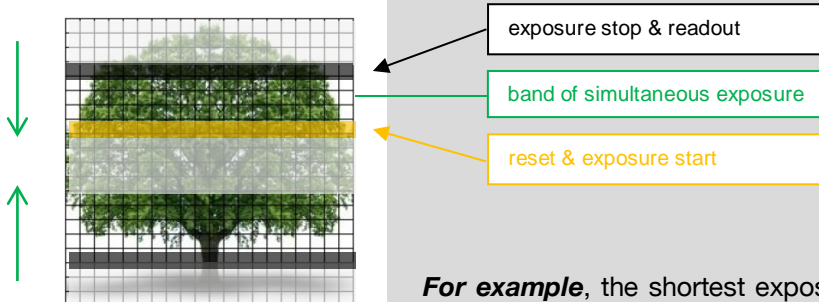

For example, the shortest exposure time in **RS** is 500 μs (pco.edge 3.1 & 5.5) and 100 μs (pco.edge 4.2). The band of simultaneous exposure is in this case (smallest possible height) at full resolution:

e.g. pco.edge 4.2: $100 \mu\text{s} / 24.93 \mu\text{s}$ (line time) = 4 \rightarrow number of simultaneous rows = 8 (Rolling Shutter **mode A-D** see **6.9.3**)

Previous comments on image distortion (also known as Rolling Shutter Effect) apply here as well.

Graph on next page.

Auto Sequence graph

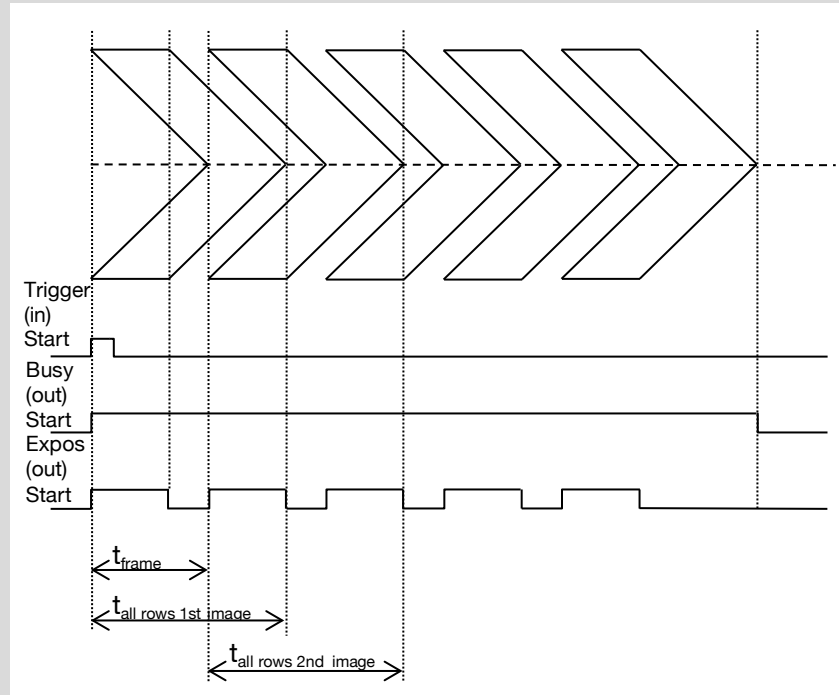

Details for External Exp. Start and External Exp. Ctrl

The detailed timing for external trigger includes system delay times, an adjustable additional delay time, and the jitter.

NOTE

The jitter t_{jit} can be a maximum of one row/line time.

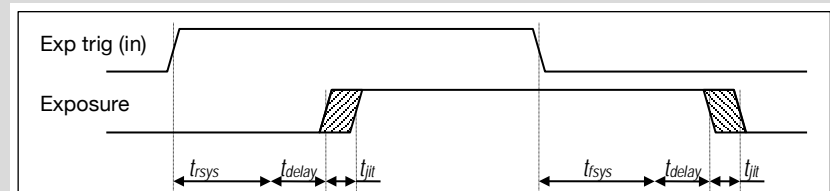

Parameter	Description	Value
t_{jit}	jitter	≤ 1 line times see p.6
t_{rsys}	time rising edge	
t_{fsys}	time falling edge	
t_{delay}	delay time	0 μ s ... 1 s

For optimized synchronization (minimized jitter time) use the falling edge of the line signal at the status output (see 6.3.8).

System times are depending on your camera settings and can be read out from your camera, for further information see SDK manual PCO_GetImageTiming.

6.3.3 GLOBAL SHUTTER

NOTE

Global Shutter is not available for pco.edge 4.2.

First, all pixels are globally reset and these reset values are shifted into so-called diffusion nodes. From there, they are non-destructively read out into memory as reset dark images. The exposure starts after transfer of the reset dark image to the diffusion nodes, where they are stored on the chip. The exposure is stopped by global charge transfer to the diffusion nodes. Then, the exposure image is read out to the memory, where the former reset dark image is subtracted to perform an external correlated double sampling, which reduces the noise. Since two images have to be read out to receive one resulting image, the sCMOS image sensor's **Global Shutter** mode has only half of the frame rate of the **Rolling Shutter** mode.

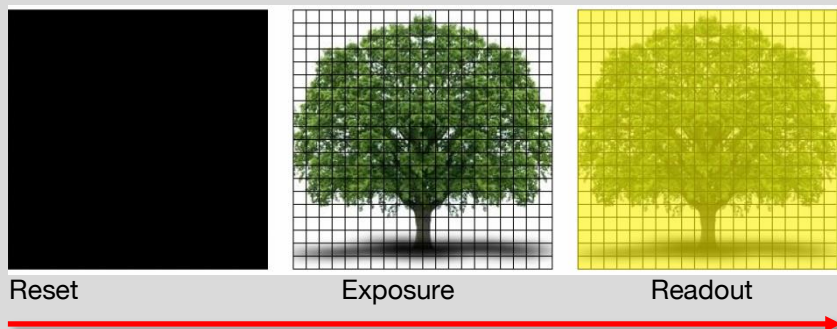

Timing

The exposure and delay time can be adjusted in steps of one line time (see page 6).

Camera (GS only)	Interface	Exposure time	Delay time
pco.edge 3.1	USB 3.0	20 μ s ... 100 ms	0 μ s ... 1 s
pco.edge 5.5	CameraLink/CLHS	10 μ s ... 100 ms	
pco.edge 5.5	USB 3.0	20 μ s ... 100 ms	

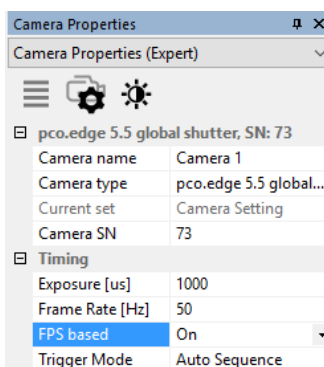

FPS based (only edge 5.5 Camera Link)

The camera will optimize the image recording to achieve the selected frame rate with chosen exposure time as close as possible.

Only for **Auto Sequence** trigger mode **and** only available with **Camera Link** Interface.

First the frame rate is set. If the time required for readout of the image is longer than $1 / \text{frame rate}$, then the frame rate will be reduced to $1 / t_{\text{readout}}$. Minimum frame rate is $1 / \text{max. exposure time}$.

The frame rate can be adjusted in steps of 1 mHz (Global Shutter). If the selected exposure time would require a lower frame rate, the exposure time is cut to the maximum possible time at that frame rate.

Camera	Interface	Frame rate (FPS Based)	Exposure time
pco.edge 5.5	CL	10 ... 50 Hz @ 286 MHz	10 μ s ... 100 ms

External Exposure Start

(Auto Sequence respectively)

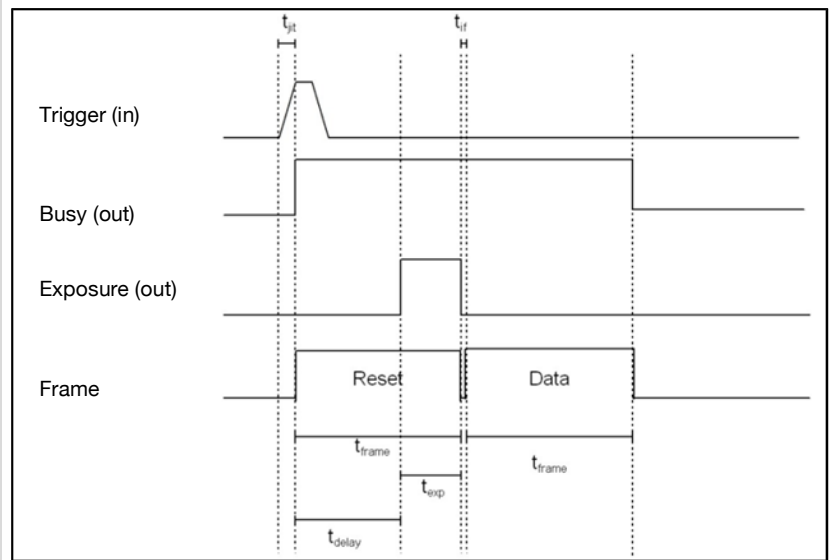

	# of lines
t_{jit}	line time ¹
t_{frame}	$\frac{ROI(y) * line\ time}{2}$
t_{exp}	Programmable: 1 line time ¹ ... 100 ms
t_{delay} (system)	$(t_{frame} - t_{exp})$
t_{if}	line time ¹

¹line time → see p.6

The listed parameters can be output via SDK function **Get Image Timing** dependent on the selected ROI.

NOTE

If $t_{exp} < t_{frame}$ system delay (t_{delay}) is added before exposure starts.

External Exposure Control

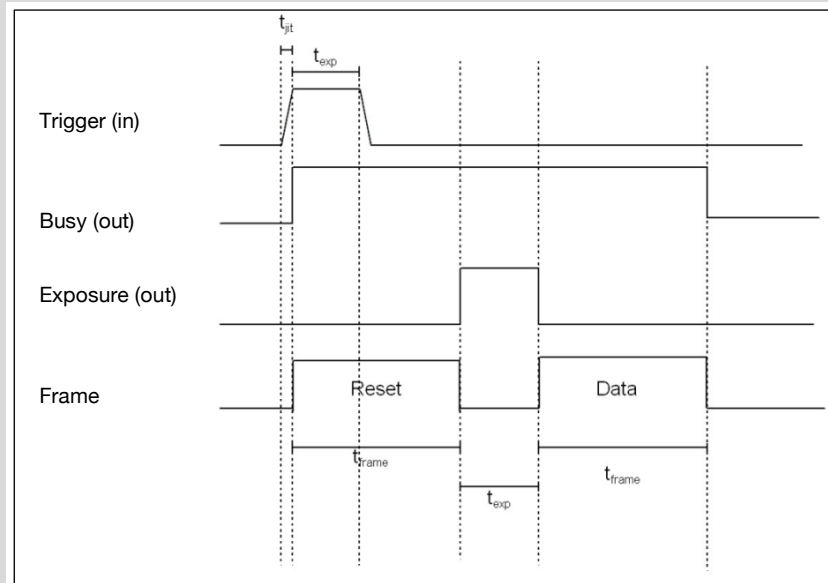

	# of lines
t_{jit}	line time ¹
t_{frame}	$\frac{ROI(y) * line\ time}{2}$
t_{exp}	Counted line time ¹

¹line time → see p.6

In **External Exposure Control** trigger mode the external signal controls start of image acquisition and duration of the exposure.

First, all pixels are globally reset and these reset values are shifted into so-called diffusion nodes. From there, they are non-destructively read out into memory as reset dark images.

In this mode, the exposure starts always after the readout of the dark image is completed. The length of the exposure has been detected by the sensor from the trigger input. The exposure is stopped by global charge transfer to the diffusion nodes after the respective time.

Then, the exposure image is read out to the memory, where the former reset dark image is subtracted to perform an external correlated double sampling, which reduces the noise.

Since two images have to be read out to receive one resulting image and the exposure cannot start during readout time of the dark image, this specific **Global Shutter** mode provides less than half of the frame rate of the **Rolling Shutter** mode.

6.3.4 GLOBAL RESET

NOTE

Global Reset is not available for pco.edge 4.2 CL / CLHS.

All pixels are globally reset and the exposure starts for all rows at the same time. The exposure stop is carried out row by row; therefore the duration of the exposure is not the same for all pixels. The rolling readout improves the image quality, but due to the difference in exposure time, a flash illumination is recommended. The readout (exposure stop) is done from the outside to the center.

General Timing Diagram

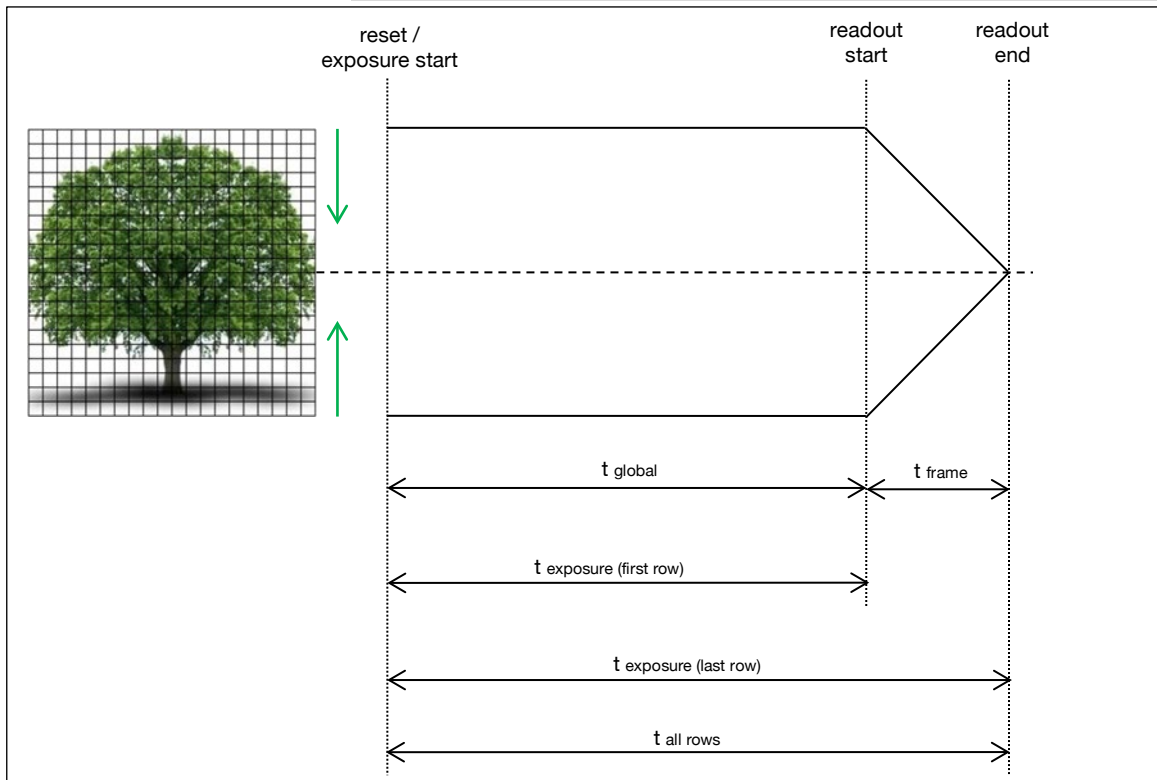

The exposure time of all rows starts simultaneously. The exposure time of the first row stops after the predefined time, the following rows are read out from the outside to the center row by row. Please note that this leads to a different duration of exposure time for all rows.

Timing

The exposure and delay time can be adjusted in steps of one line time (see p.6).

Camera Properties	
Camera Properties (Expert)	
pco.edge 5.5 global reset, SN: 73	
Camera name	Camera 1
Camera type	pco.edge 5.5 glo...
Current set	Camera Setting
Camera SN	73
Timing (95.78 fps)	
Exposure [us]	500
Delay [ms]	0
FPS based	Off
Trigger Mode	Auto Sequence

Camera (GR)	Interface	Exposure time	Delay time
pco.edge 3.1	USB 3.0	30 μ s – 2 s	0 μ s ... 1 s
pco.edge 4.2 / pco.edge 4.2 LT			
pco.edge 5.5 /			
pco.edge 5.5	Camera Link / CLHS	10 μ s – 2 s	

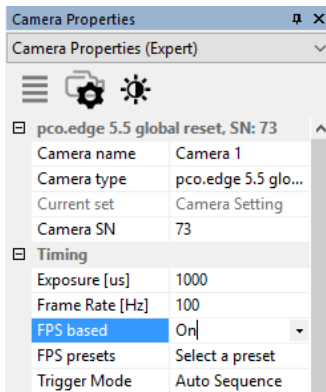

FPS based (only edge 5.5 **Camera Link**)

The camera will optimize the image recording to achieve the selected frame rate with chosen exposure time as close as possible.

Only for **Auto Sequence trigger** mode **and** only available with **Camera Link** Interface.

First the frame rate is set. If the time required for readout of the image is longer than $1 / \text{frame rate}$, then the frame rate will be reduced to $1 / t_{\text{readout}}$.

The frame rate can be adjusted in steps of **1 mHz** (Global Reset).

If the selected exposure time would require a lower frame rate, the exposure time is cut to the maximum possible time at that frame rate.

Camera (GR only)	Interface	Frame rate (FPS Based)	Exposure time
pco.edge 5.5	Camera Link	1...33.3 Hz @ 95.3 MHz	10 μ s...2 s
		1...100 Hz @ 286 MHz	

Details for External Exp. Start and External Exp. Ctrl

The detailed timing for external trigger includes system delay times, an adjustable additional delay time and the jitter.

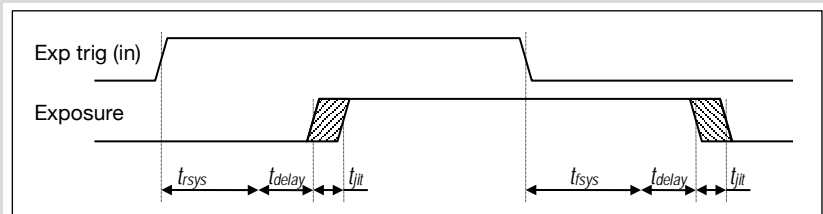

t_{jit}	jitter	≤ 1 line timesee p.6
t_{rsvs}	time rising edge	
t_{fsvs}	time falling edge	
t_{delay}	delay time	0 μ s ... 1 s

For optimized synchronization (minimized jitter time) use the falling edge of the line signal at the status output (see **6.3.8**).

System times are depending on your camera settings and can be read out from your camera, for further information see SDK manual `PCO_GetImageTiming`.

6.3.5 IMAGE SIZE

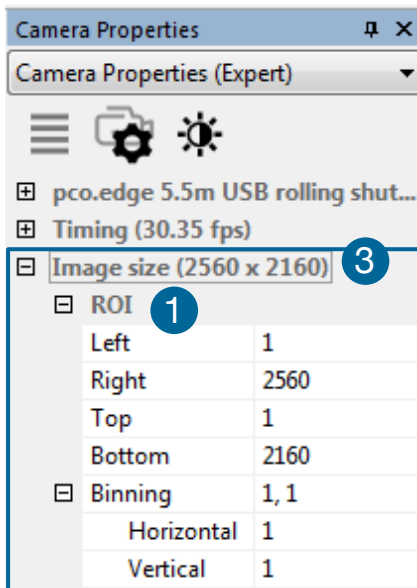

Region of Interest ①

The ROI (Region of Interest) selects only a part of the sensor to be read out.

Vertical ROI: In order to speed up the frame rate and to reduce the amount of image data, the selected ROI needs to be placed symmetrical to the horizontal center line.

Horizontal ROI: In order to reduce the amount of image data a horizontal ROI can be set. Please be aware, that changes in horizontal direction will not increase the frame rate. The decreased image size you see within Camware is a combination of reduced sensor resolution and software downsizing (Soft-ROI).

Software based ROI (Soft-ROI) is disabled within Camware by default (not available for USB 3.0 versions). Due to this functionality, the resolution of pco.edge cameras with **Camera Link interface** can be adjusted in steps of 1 – 4 pixels. Since the readout architecture of these cameras is not able to address single pixels, this downsizing is done by software. If you work with Device Adapters (µManager, Labview, etc.) or with our SDK, the Soft-ROI is disabled by default. For further information, please see the SDK description.

ROI table:

Camera	Interface	ROI, horizontal increments	ROI, vertical increments	Min. ROI	Vert. symm. ROI
pco.edge 3.1	USB 3.0	4	1	64x16	no
pco.edge 4.2	CL	1	1	40x8	no
pco.edge 4.2	CLHS	16	1	64x16	no
pco.edge 4.2 / 4.2LT	USB 3.0	4	1	64x16	no
pco.edge 5.5	CL	4	1	160x8	no
pco.edge 5.5	CLHS	16	1	64x16	no
pco.edge 5.5	USB 3.0	4	1	64x16	no

Controlling the Soft-ROI Option (only Camera Link version)

pco.edge 4.2	CL	20	1	40x8	yes
pco.edge 5.5	CL	160	1	160x16	yes

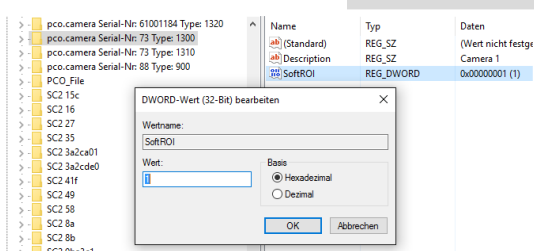

Open **regedit** to control Soft-ROI: Under **HKey-Current-User/Software/PCO/** create a DWORD value with the name **SoftROI for each camera**. Set this value to **1** in order to enable Soft-ROI. Remove or set this value to **0** in order to disable Soft-ROI by default. Keep in mind that unsymmetrical ROI decreases FPS. Table below shows values for Soft-ROI disabled.

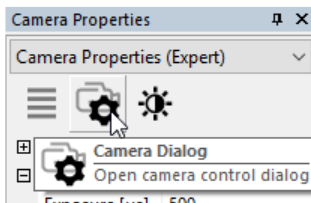

Another possibility to set ROI:

Open **Camera Control** and select the Sensor (Size) tab to easily adjust the ROI size.

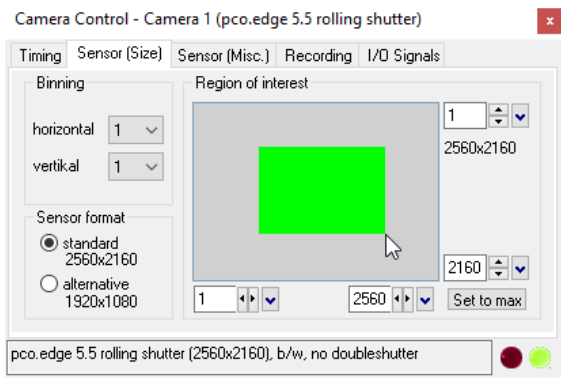

This Region of interest window allows you to draw a new ROI by mouse. The active ROI field is greened out.

Binning ②

Binning combines neighboring pixels (in either the horizontal or vertical direction) to form super pixels. It increases the signal to noise ratio (SNR), reduces the readout noise of the resulting pixels and decreases the spatial resolution of the total image, which is recorded. For further information see **A5**.

(pco.edge 5.5 CL(HS): Binning **only** in Rolling Shutter mode)

Available Binning Modes:

H1xV1, H1xV2, H1xV4, H2xV1, H2xV2, H2xV4, H4xV1, H4xV2, H4xV4.

Sensor Format ③

Camera	Interface	Preselected Sensor Format
pco.edge 3.1	USB 3.0	2048 x 1536
pco.edge 4.2	Camera Link / CLHS	2048 x 2048
pco.edge 4.2 / 4.2LT	USB 3.0	2048 x 2048
pco.edge 5.5	Camera Link / CLHS	2560 x 2160
pco.edge 5.5	USB 3.0	2560 x 2160

6.3.6 SENSOR CONTROL

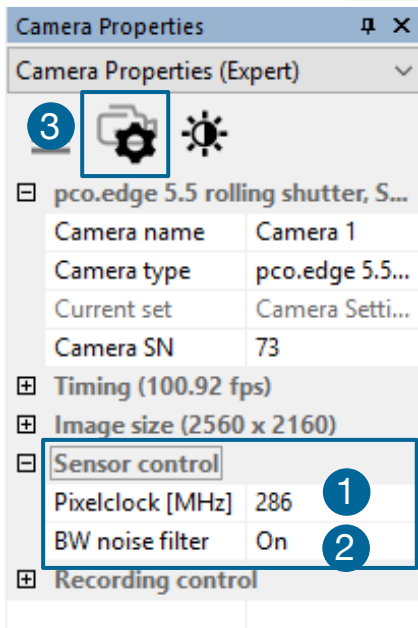

Pixelclock ①

The pixel clock sets the clock frequency and therefore the image sensor readout speed. (See pco.edge family overview table on page 6 for available readout frequencies.)

B/W Noise Filter ②

In addition to the integrated static defect pixel list processing a dynamic noise filter can be activated here in order to remove so-called **blinkers and high noise pixels**. If you encounter unexpected aliasing effects, turn this filter off.

For the following settings please start **Camera Control ③** and select Sensor (Misc.) Tab:

Conversion Factor

The conversion factor defines how many charge carriers (electrons), which have been generated by light in the image sensor in each pixel, are necessary to generate one count (one intensity level) in the digital image. Therefore, the conversion factor describes the gain that is applied to the signal before it is converted into a digital value. The conversion is optimized for the pco.edge @ 0.46 e⁻/count.

Cooling Setpoint

Display of sensor temperature: A **peltier cooling** unit is used to keep the sensor's dark current to an acceptable minimum and in order to allow for a continuous operation free of any drift phenomena in image sequences. Either an internal fan or an external water cooling system assures proper heat transfer from the **peltier** element to regulate the temperature of the cameras.

Camera	Interface	Sensor Temperature
pco.edge 3.1	USB 3.0	5 °C
pco.edge 4.2 LT	USB 3.0	10 °C
pco.edge 4.2/5.5	Camera Link	5 °C
pco.edge 4.2/5.5	CLHS	7 °C
pco.edge 4.2	USB 3.0	0 °C
pco.edge 5.5	USB 3.0	5 °C

6.3.7 RECORDING CONTROL

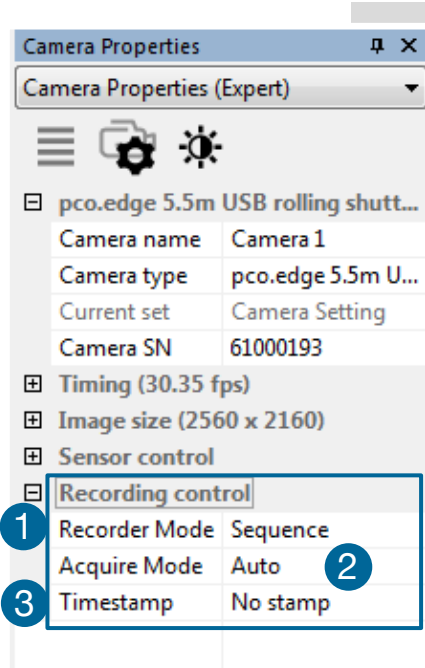
**Recorder Mode 1**

Camware will use free RAM space on your computer. The recorded images will be temporarily saved as 16bit multi TIFF. In **Sequence** mode the recording stops when RAM space is full. In **Ring Buffer** mode the camera will stop only by a stop command, hence overwriting previous images. For longer recording periods an appropriate RAID system is necessary, see also the **Direct Record to File** option, see 6.9.2.

Acquire Mode 2

The acquire mode gives you the ability to enable or disable the recording by an external signal. If set to **Auto** all images are accepted and all images taken are saved. A signal at the **acq enbl input** (see chapter 6.3.8) is ignored for this function. Operation of the acquire mode depends on the **selected trigger mode**.

If set to **External**, the camera will only record images if the external signal enables recording.

Trigger mode Auto Sequence: This sensor timing scheme is paused by the signal at the **acq enbl** input. The **acq enbl** input is sampled at the beginning of the image generation, which can be seen at the rising edge of the busy stat output. If the **acq enbl** input is high (low, when inverted) when an image is acquired, it causes an idle state until the **acq enbl** input is low (high, when inverted).

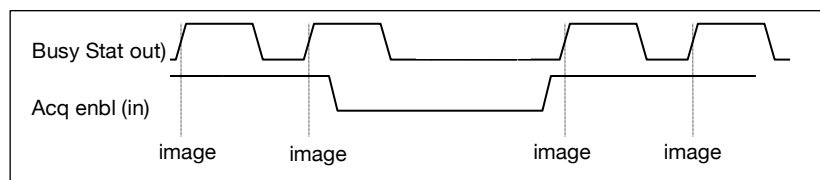

In **trigger mode External Exp. Start**, the **acq enbl** input works like a gate for the trigger signal. A trigger edge (rising, falling when **exp trig** is inverted) is accepted only when the **acq enbl** signal is high (low, when inverted).

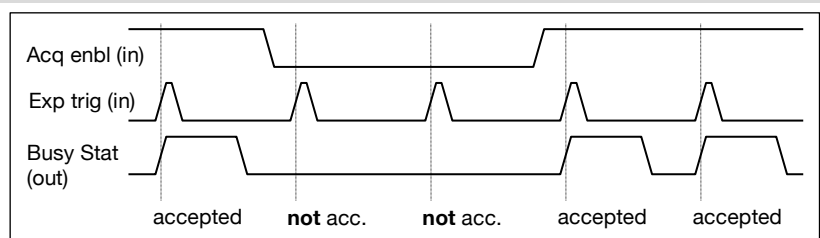

In **trigger mode External Exp. Ctrl**, the **acq enbl** input works very similar to the mode **External Exp. Start**. However, the **acq enbl** input is ignored for the edge which is closing the exposure time (started exposure will be finished accordingly).

When using **acq enbl** in **external trigger modes**, the following timing specification should be met:

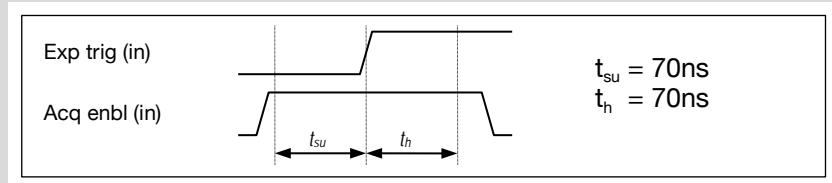

If the **acq enbl** signal changes within the window of t_{su} (set up) to t_h (hold), the behavior is random. The trigger may be accepted or ignored.

Recording control

Recorder Mode	Sequence
Acquire Mode	Sequence Trigger
Number Of Images	0
Timestamp	No stamp

Number Of Images
Specifies the number of recorded images after the event

Sequence Trigger

Once, a falling or rising edge at the **acquire enable** trigger input (see chapter 6.3.8) is recognized, an internal image counter starts to run. It will count all acquired images and will stop the recording when the predefined number of images is reached.

Example timing diagram: Trigger mode = external exposure start; Acquire mode = sequence trigger; Image counter = 3

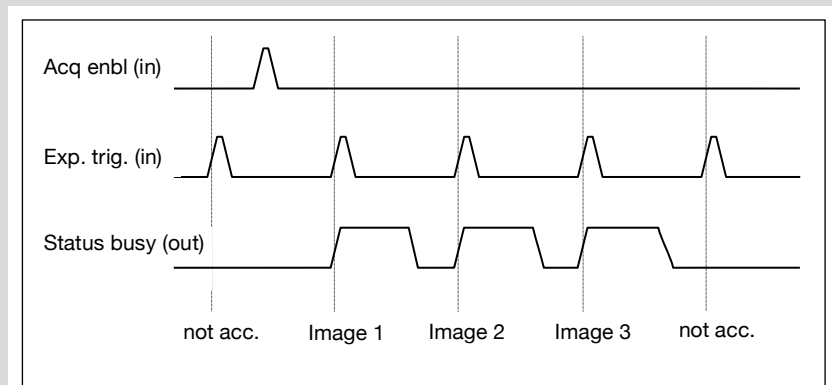

Timestamp ③

A time stamp can be placed into the upper left corner of the image. It can be either put off, binary or binary with text.

The time resolution is 1 μ s. In binary mode the first 16 pixels will be filled with the time stamp information (binary code). The numbers are coded in BCD with one byte per pixel, which means that every pixel can hold 2 digits. If the pixels have more resolution than 8 bits, then the BCD digits are right bound adjusted and the upper bits are zero. (1 BCD digit $\hat{=}$ 4 bits; 2 numbers $\hat{=}$ 2 BCD $\hat{=}$ 8 bits = 1 byte; every pixel can hold 2 digits)

For further information please refer to the SDK. In binary and ASCII mode text will be placed into the image replacing the content of the image (271x 8 pixels). Time step shows the **end** of exposure time.

Three different **information** is stamped onto the image: number of the image ①, date ② and time ③.

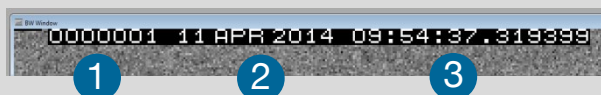

6.3.8 I/O SIGNALS TAB

Start Camera Control (see 6.3) and select the **I/O Signals Tab**.

Type	Filter	Polarity
Exposure Trigger	TTL	rising
Acquire Enable	TTL	high
Status Busy	TTL	high
Status Expos	TTL	high

pco.edge 7.5m USB rolling shutter (2560x2160), b/w, no doubleshutter

Status Expos
Status Line

Exposure Trigger ①

If checked, a signal for External Exp. Start or External Exp. Ctrl trigger mode (see chapter 6.3.1) is accepted at the **exp trig** SMA input #1.

Acquire Enable ②

If checked, a signal for Acquire Mode or Sequence Trigger Mode (see chapter 6.3.7) is accepted at the **acq enbl** SMA input #2.

Status Busy ③

If checked, a signal indicating busy status is given at the status busy output. Once an acceptable trigger edge is received, **busy** will go on status **high**. As soon as busy goes **low** again, a new trigger edge is accepted.

Status Expos ④

If checked, a signal indicating exposure status is given at the status output. Status Expos indicates the actual exposure window for one frame.

Status Line ④

If checked, a signal indicating line status is given at the status output. Use the falling line edge for optimized synchronization (minimized jitter time; see page 22).

Polarity

active for high/low signal
or rising/falling edge
Maximum low level: 0.8V
Minimum high level: 2V
Slew Rate >1ms/V

Type

TTL Electrically grounded, no opt coupler.
3.3 Volt LVTTTL out , short time short-circuit-proof.
Continuous overvoltage withstand: +10V and -5V.
1ms pulse overvoltage withstand: +33V and -33V
ESD pulse: +- 4kV

Rolling Shutter signal type

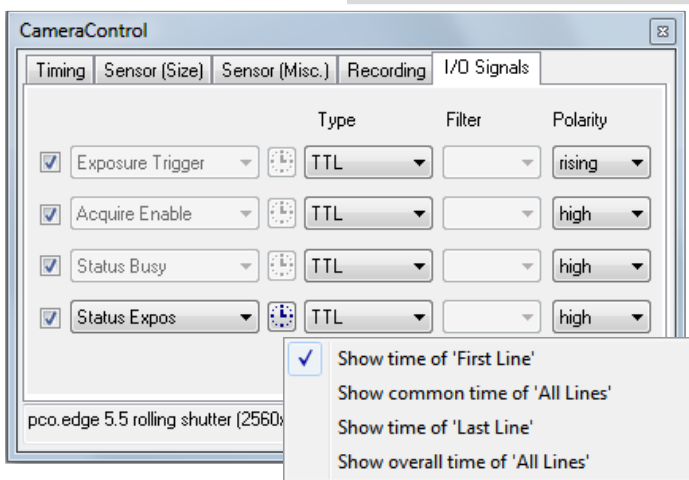

At the I/O-signal tab Rolling Shutter signal type options are available (only Status Exposure and if Shutter is set to Rolling Shutter, see 6.9.3 Setup).

There are four signal types available:

- 1 Shows the exposure time of the first rolling shutter line ($t_{\text{firstline}}$)
- 2 Shows when all sensor lines are exposed (t_{global})
- 3 Shows the exposure time of the last rolling shutter line (t_{lastline})
- 4 Shows if any sensor line is integrating (t_{alllines})

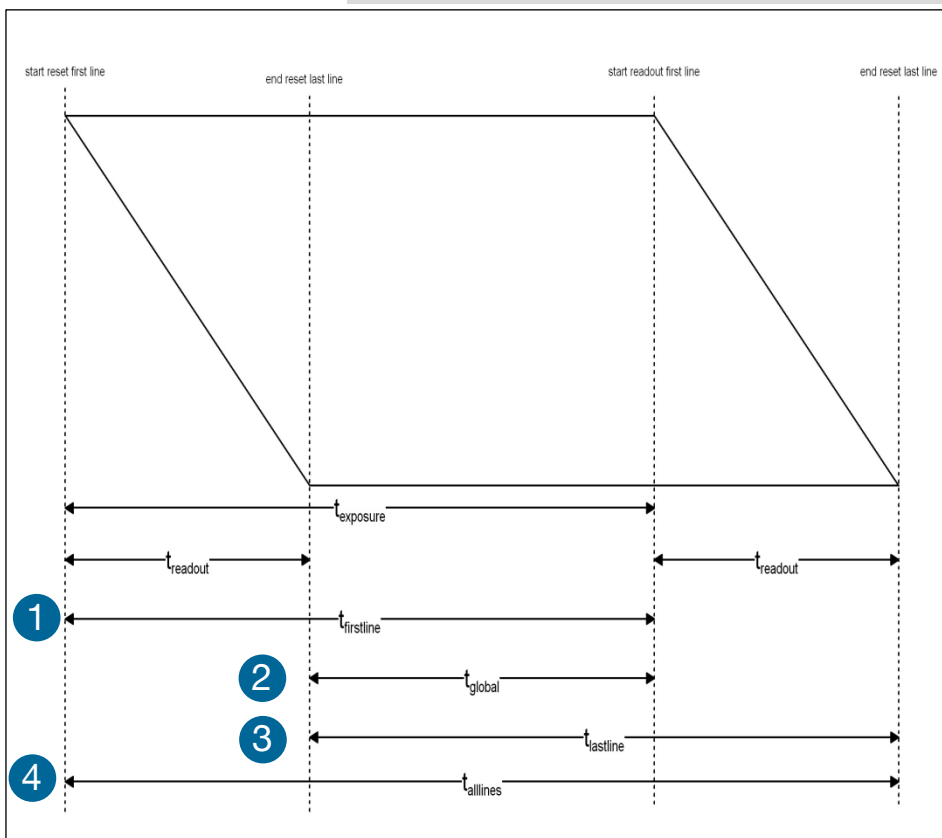

6.3.9 CONVERT CONTROL

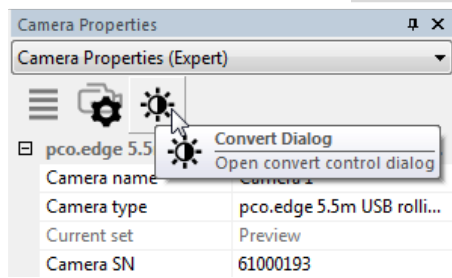

Start the **Convert Control Dialog** with the **Black/White Button** in Camera Properties.

Convert Control BW

The user can influence how the 16 bit intensity values of the original image are displayed in 8 bit values in different ways.

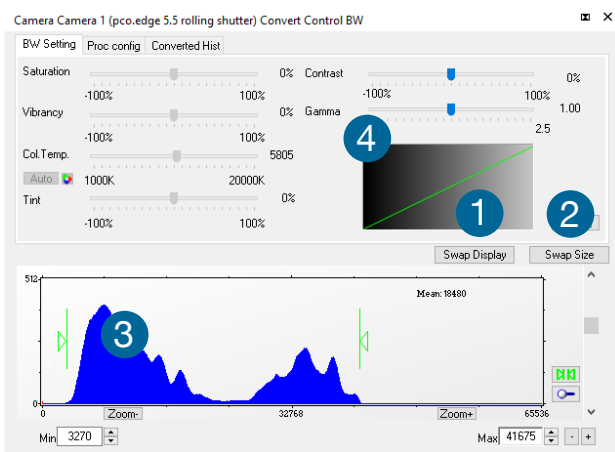

BW Settings (includes histogram of original data)

It is possible to **hide** the histogram of original data **1** and to **switch tab/histogram** **2**.

Green sliders in histogram **3**

left slider = Min controller (corresponds to value 0 of the 8 bit display). Values below that mark are set to 0, i.e. displayed as black.

right slider = Max controller (corresponds to value 255). Values above that mark are set to 255, i.e. displayed as white.

The values in-between are converted into a value between **0** and **255** according to **Contrast** and **Gamma** settings. See the small **graph** **4**, which reflects the calculation.

Proc config tab: please see under Convert Control Color

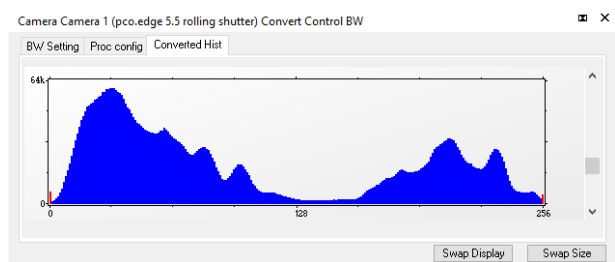

Converted Hist

This tab shows you the **histogram of converted data**.

Convert Control Color (only pco.edge color)

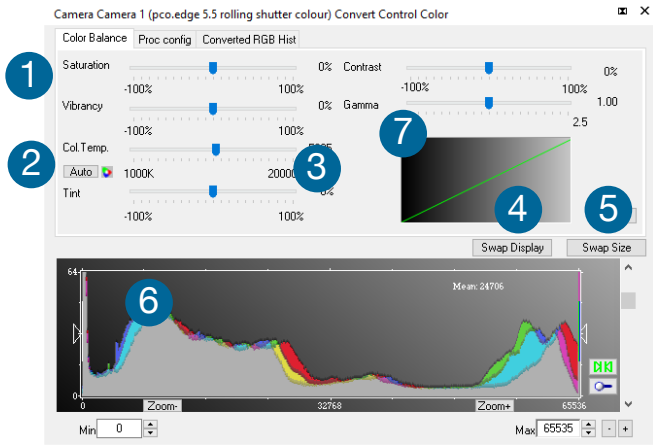

Color Balance (Histogram of original data)

Intensity of single color can be controlled by **Saturation** and **Vibrance** ①.

Press the Auto button to set the **white balance** ②.

The balancing of RGB can be controlled by **Col.Temp** and **Tint** ③.

It is possible to **hide the histogram of original data** ④ and to **switch tab/histogram** ⑤.

The user can influence how the 16 bit intensity values of the original image are displayed in 8 bit values in different ways.

White sliders in histogram ⑥

left slider = Min controller (corresponds to value 0 of the 8 bit display). Values below that mark are set to 0, i.e. displayed as no color.

right slider = Max controller (corresponds to value 255). Values above that mark are set to 255, i.e. displayed as full color.

The values in-between are converted into a value between 0 and 255 according to **Contrast** and **Gamma** settings. See the small **graph** ⑦, which reflects the calculation.

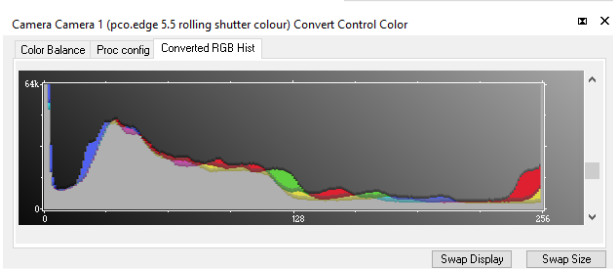

Converted RGB Hist

This tab shows you the **histogram of converted data**.

Proc. Config (Process configuration)

Due to proprietary high-end algorithms used for these image processing features, no detailed description is given here

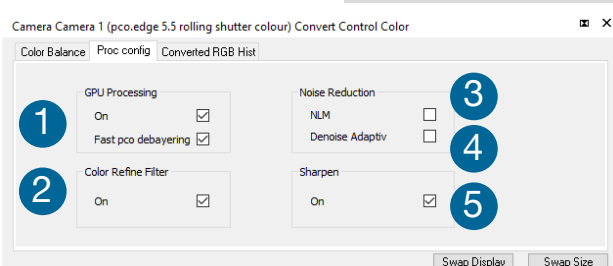

- ① switch on in order to significantly reduce processing time (increases refresh rate of the live image)
- ② pixel color correction
- ③ non local means algorithm
- ④ adaptive to brightness and patterns
- ⑤ sharpen

6.4 IMAGE OVERLAY



Open **Image Overlay**: you can easily switch between **Camera Properties** window and **Image Overlay** with these two buttons. **1**
 If not available: see Fehler! Verweisquelle konnte nicht gefunden werden. **View Menu** to activate this menu.

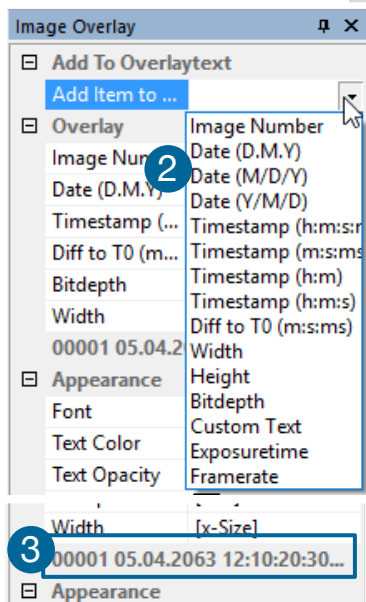

This function enables an individually configurable image overlay. Many different options are available by clicking **Add item to...** **2**

Also the **Appearance** is configurable: Font, Text color, Text opacity, Background color, Background opacity and horizontal or vertical orientation.

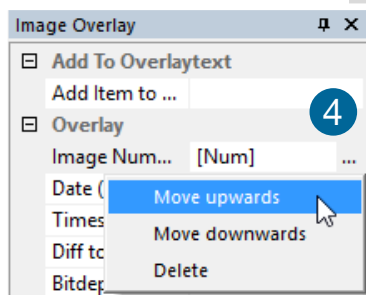

A preview of the image overlay is shown. **3**

Each item can be moved upwards, downwards or deleted by clicking on **...** **4**



By **drag & drop** the **Image Overlay** can be moved easily to your favorite position.

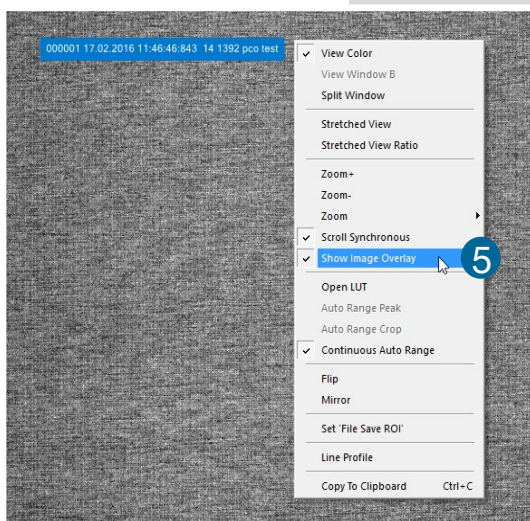

To activate image overlay **right-click** in the image window and activate **Show Image Overlay**. **5**

6.5 RECORDER TOOLS

Recorder Tools provides **Record** and **Play** function, **Play Settings** and **Record Settings**.

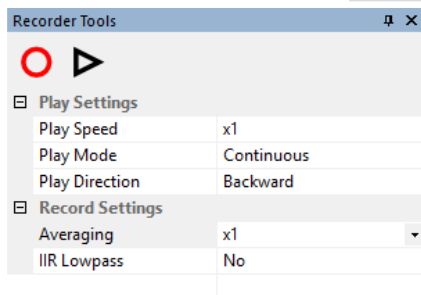

Play Settings:

Play Speed: selectable play speed from x1 to x256 or from 1fps to 16fps. E.g. in mode x1 a recording with 1000 fps is played with 25fps.

1 fps means that only one frame per second is played.

Play Mode: selectable play mode of the recorder (continuous or single time (re)play).

Play Direction: selectable direction of record play (forward or backward)

Record Settings:

Averaging

If in the dropdown list a value not equal to x1 is selected, the corresponding number of images is averaged in the buffer, reducing the statistically independent noise.

IIR Lowpass

Another option to reduce the noise is the activation of the **Infinite impulse response IIR lowpass filter**. This filter takes 90% of the previous image and 10% of the new image to create images with clearly reduced noise.

$$\text{Image (actual)} = \text{Image (act - 1)} * 0.9 + \text{Image (new)} * 0.1$$

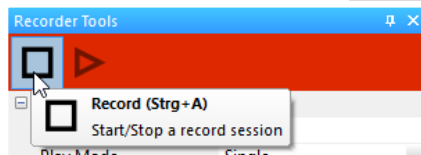

Recording: in record state Camware software is highlighted in red.

Start/Stop record: with Record Button.

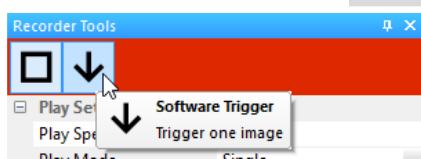

Software Trigger Mode: after record is started an arrow pointing downwards applies a single trigger.



Extended Recorder can be activated (see 6.9.5)

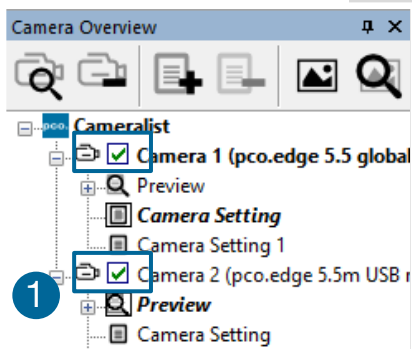

Recording with multiple cameras:

If all cameras are activated the recording is started simultaneously for all cameras.

Recorder will use Recorder mode settings (Sequence or Ring Buffer) of the selected camera for all cameras (see 6.3.7)

For single camera recording, deactivate cameras by removing the check mark from the box. ❶

6.6 VIEW WINDOW

More View Windows

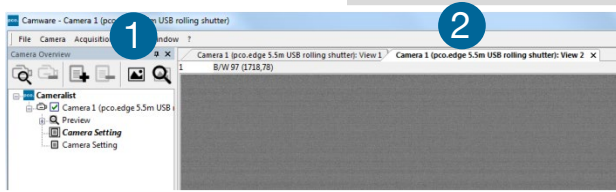

It is possible to open more view windows of one camera: just click on **new view window** 1 and Camware will create a new one 2. Even when multiple view windows (or from multiple cameras) are open, the same image number is always shown in all of the view windows.

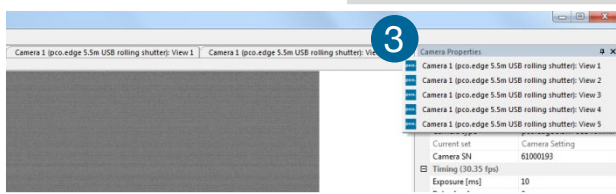

A **dropdown menu** 3 helps to select a view window. If you have more view windows than can be displayed on the desktop, you will be able to select each view window.

Split View Window

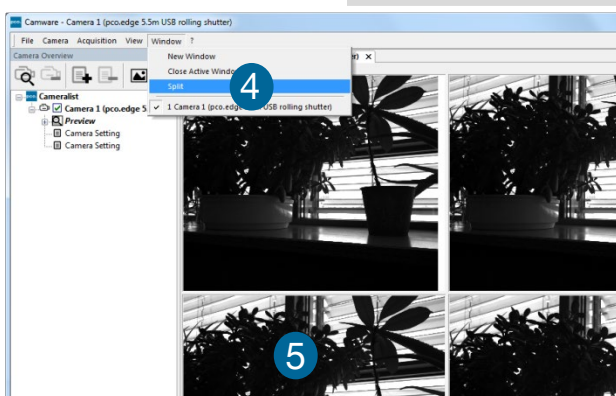

The view window can be split. Choose **Window** → **Split** 4 and a split cross will be shown. You can easily adjust the size of the splitted window elements by grabbing and dragging the dividing lines 5.

The main function is that you are able to view four regions of your image in one view. Choose the **Zoom±** function to zoom in the image (first turn off **Stretched View**) (See 6.9.8)

If you want to undo the split, you have to double click on the

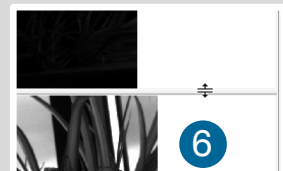

deviding line (after symbol 6 is visible).

Two Tabs side by side or on top of each other

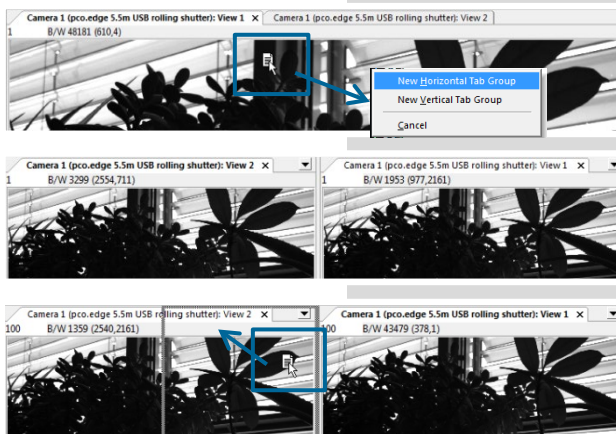

If you want to view two tabs side by side or arranged one above the other just drag a tab and then Camware will ask you if you want to create a new horizontal or vertical tab group. Undo this very easily by dragging the tab back to its former position.

This also applies for view windows of several cameras.

6.7 RECORDER (IMAGES)

When recording is done, small preview images (thumbnails) are built and displayed automatically. This will take some time depending on the performance of your computer system.

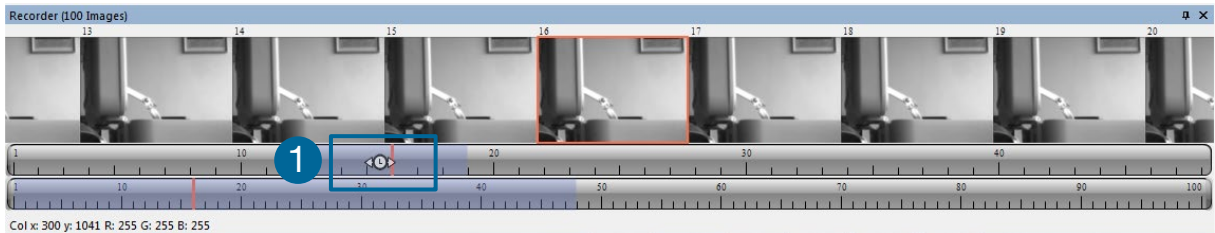

If you click (left mouse button) within the upper scale bar **1**, you can adjust the number of images which are shown by moving the mouse (left or right). (minimum is **20** and maximum is **half of the recorded images** in this scale)

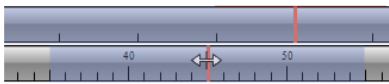

Quick scrolling: you can quickly scroll through the thumbnails by dragging the orange bar with the mouse.

If you click on a thumbnail image it will be shown on the view window. You can scroll **via mouse wheel** through the thumbnails. The upper **blue bar** correlates to the number of displayed thumbnails. The lower blue bar shows the range of the upper scale in relation to the whole record.

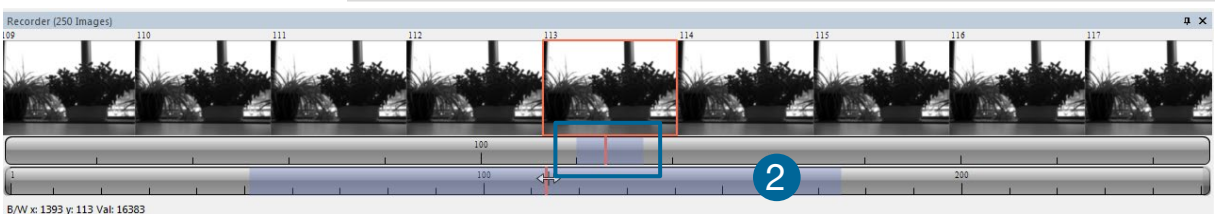

The second scale shows the total number of recorded images. It allows to scroll fast through the images **2**.

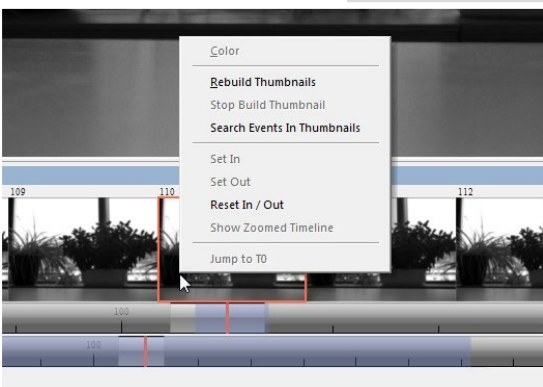

Right-click menu (click on thumb-nails): Allows you to rebuild all thumbnails and to search for events.

Furthermore the **Set In / Out** gives you the possibility to set values for a sequence, which can be played via play button. Reset In / Out discards these settings.

Set In / Out is active: if you **save/export** your images, only the selected images are saved/exported (see 6.9.2).

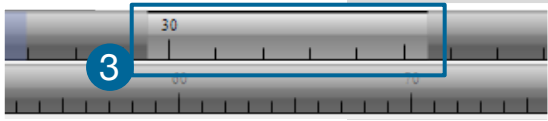

The **light gray area** ③ in the upper scale shows an **In-Out** example area. It is very easy to define a new area: just **right-click on the start and end frame** in one of the scales. The **In** image must be left to the red bar, the **Out** image to the right of the red bar.

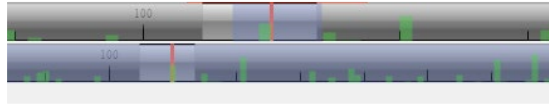

Search Events in Thumbnails: Detected events are displayed as **green bars**

Too dark or bright thumbnails:

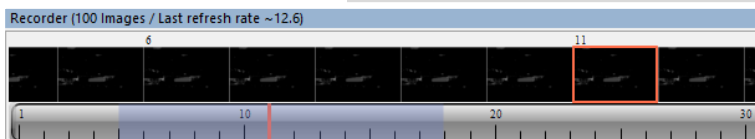

If thumbnails are too dark or too bright, right-click in view window (see 6.9.8) and select **Auto Range Peak** or **Auto Range Crop**. Then

right-click on a thumbnail image and select **Rebuild Thumbnails**. Now the thumbnail images should comply with the view window.

6.8 SETTINGS OVERVIEW

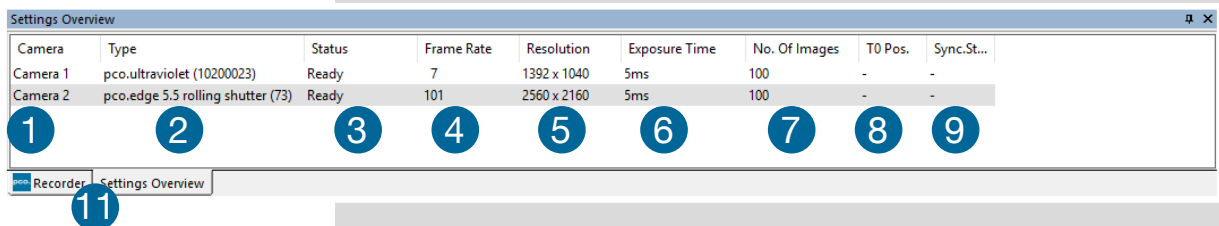

Settings overview shows the most important parameters of your camera at a glance. If you have more than one camera connected, each camera and its parameters are listed.

The parameters can only be changed under **6.3 Camera Properties**.

It is possible to easily switch between the **Recorder (Images)** section and the **Settings Overview**. ⑪

No.	Function	Description
①	Camera name	Name
②	Type	Camera type and serial number
③	Status	Ready or Recording
④	Frame rate	Currently selected frame rate
⑤	Resolution	Resolution in pixels
⑥	Exposure time	Selected exposure time
⑦	Number of images	Number of images to be recorded
⑧	T0 Position	Not available for pco.edge
⑨	Synchronization Status	Not available for pco.edge

6.9 CAMWARE TABS & FEATURES

This chapter describes in detail the Camware Demo Mode and the Camware Tabs: File, Camera, Acquisition, View and Window. Furthermore the right-click menu and some additional features are listed.

6.9.1 DEMO MODE

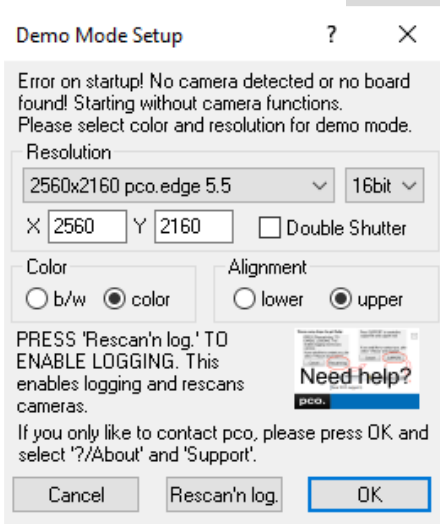

When Camware is started, it automatically recognizes the camera type of the connected and running cameras.

Camware will start in Demo Mode, if your camera is switched off or no camera is connected

In this mode all **image processing** features are available, but all **camera settings** are deactivated. The user only has to tell Camware what type of image he wants to open. For that purpose, the **Demo Mode Setup** window opens and asks for the corresponding input.

Need Help? If this window pops up because you have trouble running the camera, please see instructions in appendix **A8**.

Resolution

The drop down list displays the existing image sensor spatial resolutions of all PCO camera systems. Please select the specific resolution and bit depth of the images to be opened. If double shutter images have been recorded and should be opened, Double Shutter Mode should be checked.

Color

With the radio buttons, the user can specify whether the image type is monochrome (b/w) or color.

Alignment

These two radio buttons adjust whether MSB (most significant bit) aligned (upper) or LSB (least significant bit) aligned (lower) images have been stored.

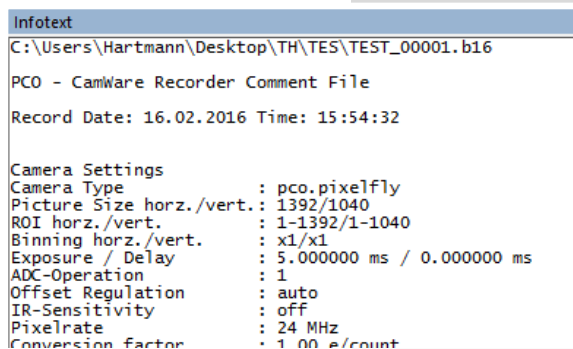

Infotext

The **Infotext** is automatically shown in Camware if you open a stored image.

The **Camera Properties** settings, storing location and Record date are listed in this file.

Infotext can be activated in the View Menu **6.9.5** at any time.

6.9.2 FILE MENU

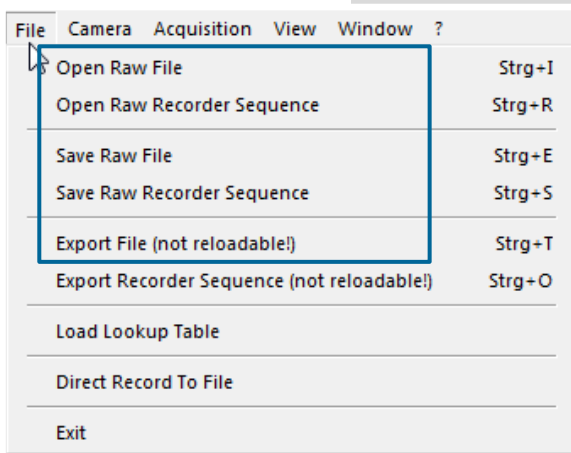

Open RAW File (single image only)

This command should be used to import a single image into the currently active image window. Only files with the extension and format of ***.b16 (=PCO proprietary binary image format)** and *.tif (16 bit TIFF image format) can be imported. If the recorder is enabled, each imported image will be transferred to the buffer shown in the picture number. The image itself will be fitted to the current image size. If the recorder is disabled, the current image sizes will be set to the parameters of the imported image.

Open RAW Recorder Sequence (image sequence from one camera)

This command is used to import a sequence of images. If more than one camera is connected and an image window is currently open, the sequence will be loaded to the active window. If no image window is open, the images will be loaded to camera #1. This command opens the Open file dialog box. Only files with the extension and the format of ***.b16**, ***.pcoraw**, ***.tif** and **multi tif** can be imported.

NOTE

Be aware of the different storage abilities of the formats, for example *.bmp - the bitmap format only allows for 8bit values to be stored and therefore the image content of a 16 bit image is reduced, if stored as bitmap.

Save RAW File (single image only)

This command should be used to save the image, which is displayed in the active window. The command opens the Save file dialog box. The image file can be saved in **16bit *.b16** and ***.tif** format. If more than one camera is connected, it is possible to save all current images by selecting Export all images in the Save file dialog box. With this feature it is possible to save one image of each active camera within one process step (it is not necessary to repeat the save process for each camera). The Save command will not be available, if no image window is open.

Save RAW Recorder Sequence (image sequence from one camera)

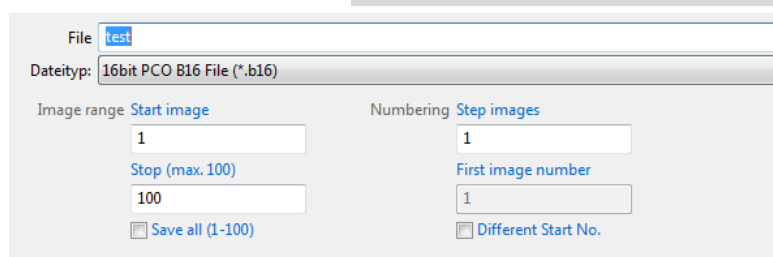

The Save Recorder command should be used to save or export image sequences. If more than one camera is connected and an image window is currently open, the record of the active window will be saved. The command opens the Save recorder file dialog box. It is possible to select

the number of saved images, to step images and to choose the first image number.

Export File (not reloadable!)

Use this command to export the image of the active image window. This command will open the Export Image dialog box. Files with the extensions fts, tif, bmp, asc, jpg, and jp2 can be exported. This item will not be visible, if no image window is open

Save Raw File	Strg+E
Save Raw Recorder Sequence	Strg+S
Export File (not reloadable!)	Strg+T
Export Recorder Sequence (not reloadable!)	Strg+O
Load Lookup Table	
Direct Record To File	
Exit	

Export Recorder Sequence (not reloadable!)

Use this command to export a sequence of images. If more than one camera is connected and an image window is currently open, the record of the window which has got the input focus will be saved. If no image window is open the Export Recorder Sequence menu does not appear. This command will open the Export recorder box. Files with the extensions fts, tif, bmp, asc, avi, mpg, jpg, jp2, and wmv can be exported (see Appendix A6).

Load Lookup Table (monochrome cameras only)

With the Pseudo LUT (Lookup-Table) feature you can load any LUT with one of four different formats and you can view the result in the color view window. Use one of the attached predefined LUTs or define your own.

Direct Record to File

This command is intended for cameras without internal memory. With this command you can preset a certain number of images to be stored. If the camera captures images faster than the computer can save to disk, then you will lose images. The displaying of the images doesn't interfere with the record process.

Exit

This command exits the program and closes all channel dialog windows. Window positions, settings and sizes are stored in the windows registry and will be loaded again at next start-up.

6.9.3 CAMERA MENU

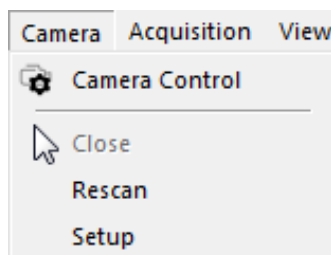

Camera Control

Use this command to open the camera control window.

Close

Disconnects camera and switches Camware to Demo Mode. In case of multiple cameras, all cameras must be closed in order for Camware to switch to Demo Mode.

Rescan

Disconnects and reconnects all cameras.

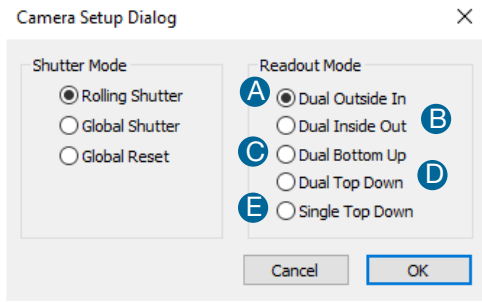

Setup

Switch between Rolling Shutter, Global Shutter and Global Reset Mode. The camera will automatically restart.

Five different readout modes are available in **Rolling Shutter (6.3.2)**. Standard mode is **Dual Outside in**. In **Single Top down**, the pco.edge provides only half of the normal frame rate. Camware rotates the image that was recorded by the sensor, by 180°. This means, that the last line of the image is the first line of the sensor. PCO SDK names are from A to E.

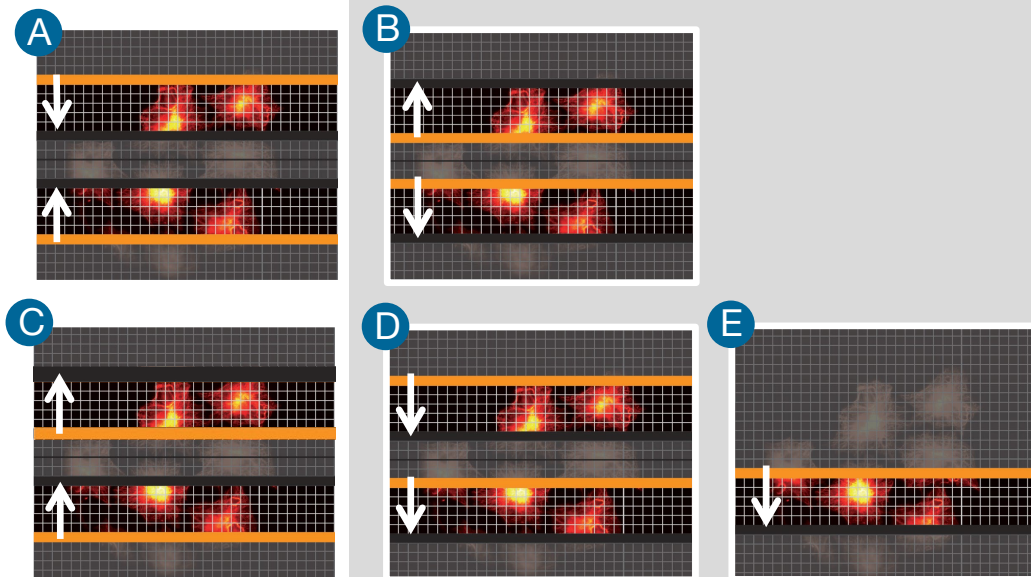

6.9.4 ACQUISITION MENU

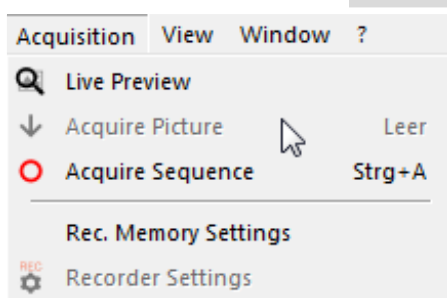

Live Preview

The **Live Preview** is useful for fast and easy adjusting and focusing of the camera. The active window will be updated. To see another window, simply click on the window. This option is not available in double shutter mode.

Acquire Picture (not available)

Acquire Sequence

Starts recording images into the system memory according to Trigger Mode selection (see 6.3.1). During recording, all camera controls are locked.

Memory Allocation Dialog

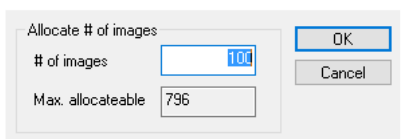

Rec. Memory Settings

This sets the number of images recorded in one sequence. The maximum is defined by approved RAM size.

6.9.5 VIEW MENU

	<p>B/W or Color Window Use this command to open a new display window.</p>
	<p>Convert Control See chapter 6.3.9</p>
	<p>Toolbars and Docking Windows Standard toolbars of Camware 4 are Recorder/ Recorder Tools / Camera View / Camera Properties and Image Overlay. Additional Toolbars known from Camware 3.x are displayable, but not essentially needed: Main Toolbar / Extended Recorder / Cursor. For function Infotext see 6.9.1.</p> <p>Application Look The Style and Look of Camware can be customized; many different style sheets are selectable. The Tabbed MDI function (un)docks the view windows.</p>
	<p>Reset layout to default This resets all your customized changes and restores the default layout.</p>

6.9.6 WINDOW MENU

	<p>New Window A new view window will be opened.</p>
	<p>Close Active Window Active window will be closed.</p>
	<p>Split The view window will be split in four quarters.</p>
<p>Camera overview Shows all connected cameras.</p>	

6.9.7 HELP MENU



Contents
Opens the main page of the program help.

Search for Help on
Opens an index list for help.

Create Support File
This will activate the Camware log files. Press **YES** to activate log files and reboot Camware and your pco.edge. After log files are activated it is possible to create a support file. Please send this file to the PCO support.

Logging
Enable Logging:
Activates Camware log files (this cuts down performance)
Clear Logfiles: (only visible if logging is enabled)
This command erases all actual log files
Explore Logfiles:
Opens windows explorer
Disable Logging (only visible if logging is enabled)
Disables logging

Support Mail
This command opens your email-program and an already created support file will be added automatically as file attachment.

About Camware
This window shows program information.

Generate support file?
This will generate a file called *CWSupport.zip*, which will be attached to the mail, if selected. It will contain some logfiles and additional info about your system:
PCO_Reg.txt (Registry entries about driver)
Conflicts.nfo (Info file about the computers hardware).

Yes No

Camware 4

Contents
Search for Help on
Create Support File
Logging
Support Mail (+Support File)
About

Enable Logging
Clear Logfiles
Explore Logfiles
Disable Logging

use this software to control all available versions of pco cameras dimax, pixelfly USB, pco.edge, Camware V04.01/864

OK

6.9.8 RIGHT-CLICK MENU

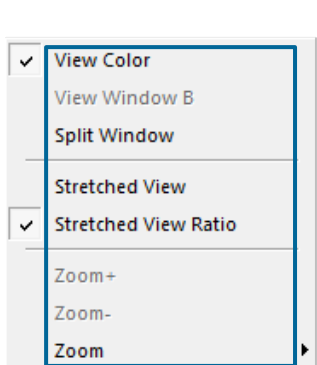

View Color: color window

View Window B: if Double Shutter mode is activated, this will switch to window B (second image)

Stretched View: image will be fitted into the display window

Stretched View Ratio: aspect ratio is maintained

Zoom +/-: image zoom (only available if **Stretched View** is deactivated)

View Color
View Window B
Split Window
Stretched View
Stretched View Ratio
Zoom+
Zoom-
Zoom

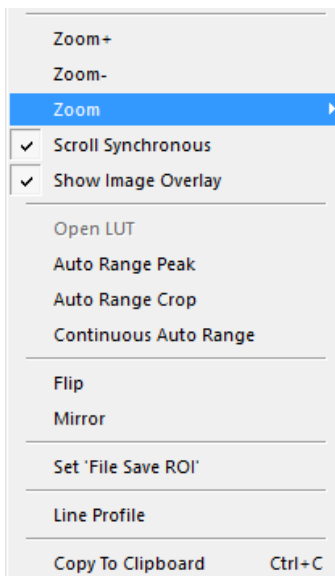

Zoom set the factor of the Zoom (from 0.0625 to 32)

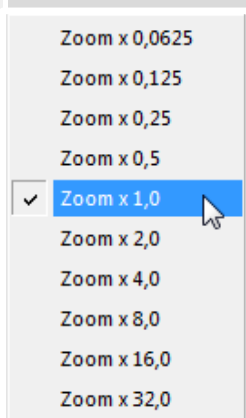

Scroll Synchronous if more than one image window is opened, it is possible to scroll synchronously through the images (only available if **Stretched View** is deactivated)

Show Image Overlay: activates the overlay see 6.4

Open LUT: opens **look-up table** file for false-color illustration

Auto Range Peak searches for the minimum and maximum 16 bit intensity values of the image. Given these numbers the converter scales the 8 bit display (256) within these two values.

NOTE

Right-click in the View window to open this menu.

Auto Range Crop sets the converter to ignore the extreme intensity values of the image and scales the display in a smaller range. Thus dark or bright light spots, reflections, etc. are cut off.

Continuous Auto Range (Crop):

This option enables the automatic min/max function during record and replay.

Flip/Mirror: image will be flipped or mirrored

Set 'File Save ROI': if you want to save just a part of the recorded image (region of interest), it is possible to draw a rectangle with the mouse. This rectangle is valid for all recorded images and can be dragged at its edges.

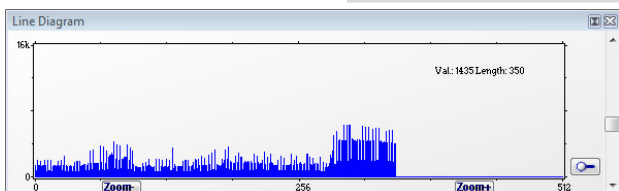

Line Tool

Select **Line Tool** to display a graph, which shows the intensity of the pixels under the red line shown in the image window. The selection of this menu item determines the location of the first point. After this you can move the mouse to the second point, which can be

selected by a **left click**. Now a **Line Diagram** opens and the length of the line (unit: pixel) is shown in a bubble and displayed in the window.

Copy to Clipboard: will copy the actual image to clipboard

6.9.9 ADDITIONAL FEATURES

White Balance by Mouse

It is possible to change **white balance** easily by mouse: You only have to press the CTRL (Strg) and the shift button at the same time and select a white or gray area within the image. The pixel values within the coordinates of the selection rectangle are used for calculating a new **white balance**.

For best results we recommend to use the white balance button in the Convert Control Color (see 6.3.9).

Fold Up Window

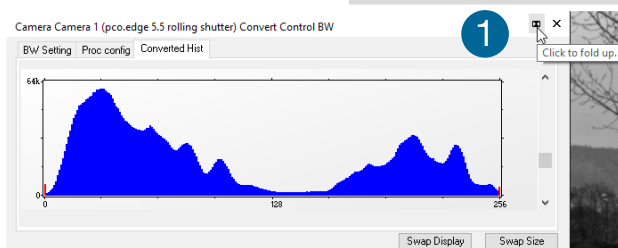

The Convert Control windows can be minimized / folded up ①. Just move the pointer over the bar and the window will unfold again ②.

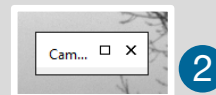

Setting Contrast Area by Mouse

You can control the minimum and maximum values used for the conversion from 16 bit to 8 bit with the mouse. Move the mouse cursor into a region which should be shown with maximum contrast. Press the shift and the left mouse button. Hold down the mouse button while increasing the size of the selection rectangle with mouse moves. After releasing the mouse button the coordinates of the selection rectangle act as a border for calculating the minimum and maximum values.

Setting a new ROI by Mouse

In the same manner you can setup a new region of interest (see 6.3.5 **ROI**) for the camera. You only have to press the CTRL (Strg) button and drag an area with the left mouse button. The coordinates of the selection rectangle are used for calculating a new region of interest, which will be adapted to the camera capabilities automatically. You can reset the ROI to maximum by pressing the CTRL (Strg) button and the right mouse button.

Short Cut List

- Acquire Picture: SPACE
- Acquire Sequence: STRG + A
- Export File (Image): STRG + T
- Export Recorder Sequence (Video) STRG + O
- Open Raw Image File: STRG + I
- Open Raw Recorder (Video) Sequence: STRG + R
- Save Raw Image File STRG + E
- Save Raw Recorder Sequence (Video) STRG + S

APPENDIX

A1 TECHNICAL DATA	51
A1.1 STANDARD VERSION	51
A1.2 WATER COOLED STANDARD VERSION	51
A1.3 CAMERA LINK HS VERSION	52
A1.4 SPECIFICATIONS	53
A1.5 MOUNTING	53
A1.5.1 INSTABLE MOUNTING	53
A1.5.2 CORRECT MOUNTING	54
A1.5.3 COOLING	54
A1.6 REVERSE WITH CAPTION	55
A2 CHANGE FROM F-MOUNT TO C-MOUNT	56
A3 WATER COOLING OPTION PCO.AQUAMATIC II	57
A3.1 SYSTEM COMPONENTS	57
A3.2 FIRST TIME INSTALLATION	58
A3.3 OPERATION	59
A3.4 DIMENSIONS	60
A4 INTERFACES	61
A4.1 CABLE POSSIBILITIES	61
A4.2 CAMERA LINK	62
A4.2.1 INSTALLATION OF FRAME GRABBER	62
A4.2.2 MICRO DIAGNOSTICS TOOL	63
A4.2.3 IMAGE DATA FLOW	64
A4.3 CAMERA LINK HS	66
A4.4 USB 3.0	67
A4.4.4 DRIVER INSTALLATION	67
A4.4.5 HARDWARE RECOMMENDATIONS	67
A4.4.6 USB 3.0 FAQ	69
A4.4.7 INSTALLATION OF THE USB 3.0 CARD	71
A4.4.8 RING BUFFER AND FIFO	72
A5 BINNING WITH CMOS SENSORS	73
A6 LIGHTSHEET SCANNING MODE	74
A7 IMAGE FILE FORMATS	75
A8 CUSTOMER SERVICE	77
A8.1 SERVICE	77
A8.2 MAINTENANCE	77
A8.3 RECYCLING	77
A8.4 TROUBLE SHOOTING	78
A9 INDEX	79
ABOUT PCO	80

A1 TECHNICAL DATA

A1.1 STANDARD VERSION

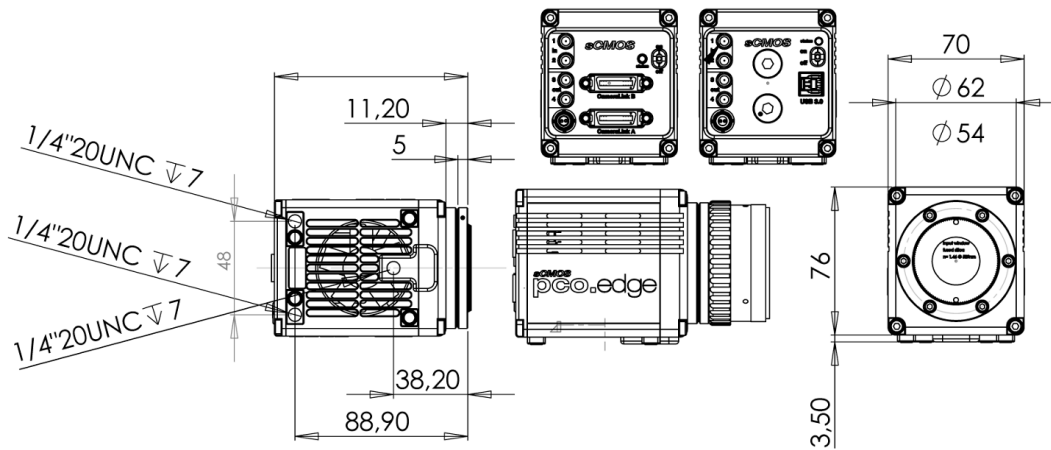

(pco.edge 3.1/ 4.2 (LT) / 5.5: Camera Link or USB 3.0)

A1.2 WATER COOLED STANDARD VERSION

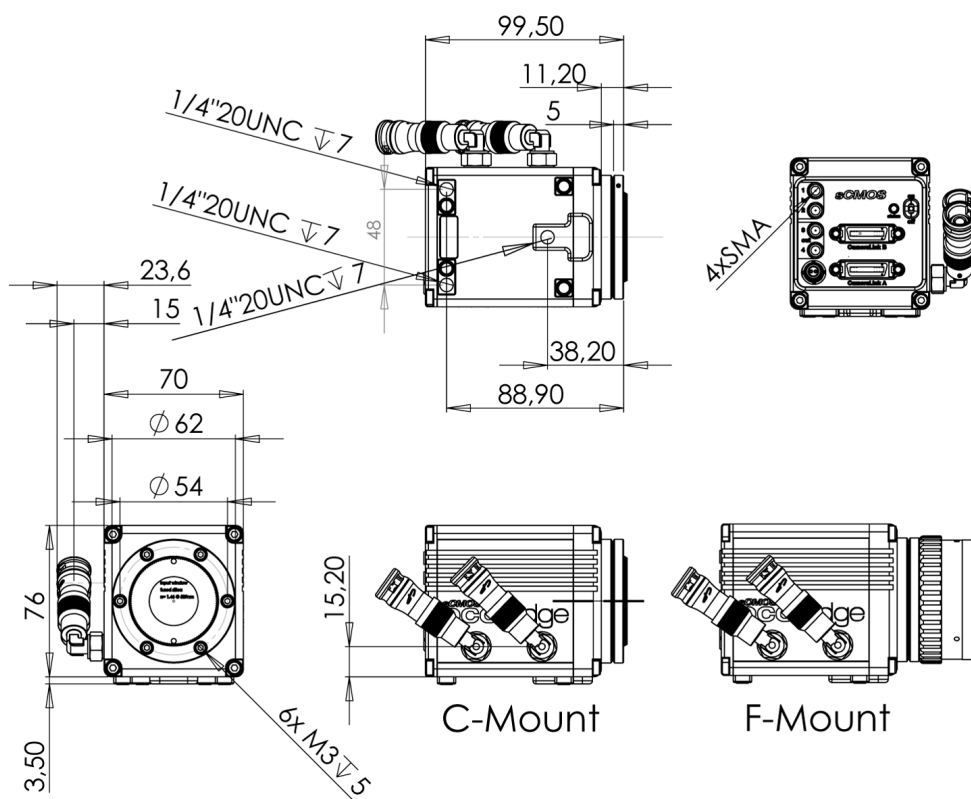

(pco.edge 4.2 / 5.5 Camera Link)

Water Cooled Standard Version (pco.edge 4.2 / 5.5, USB 3.0)

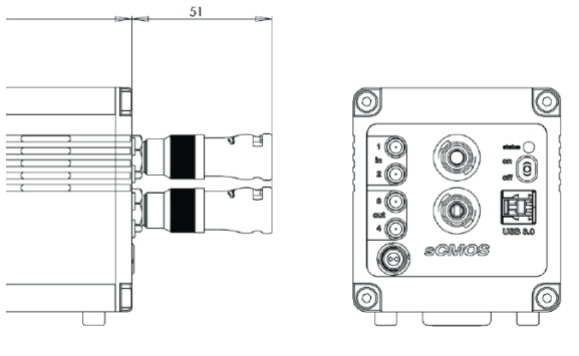

The housing size is similar to the dimensions of the standard version, except the camera design with the USB 3.0 interface allows locating the water connections on the back of the camera.

A1.3 CAMERA LINK HS VERSION

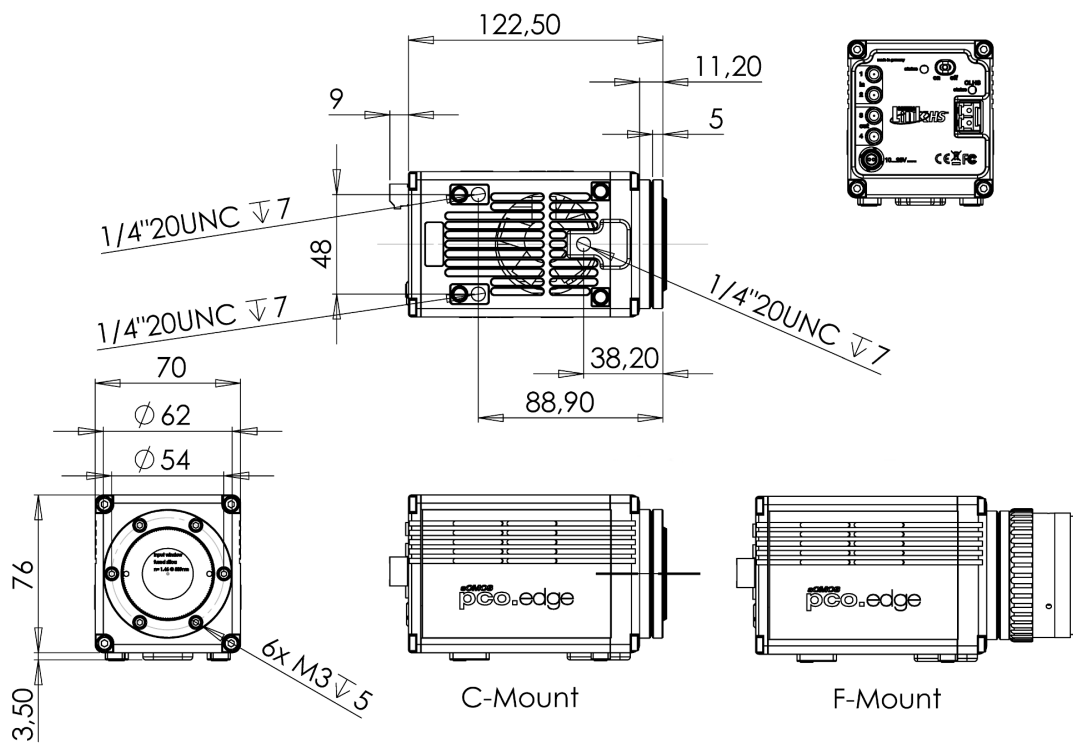

(pco.edge 4.2 / 5.5 Camera Link HS)

A1.4 SPECIFICATIONS

General	
power supply	12 .. 24 VDC (+/- 10 %)
power consumption	21 W max. (typ. 11 W @ 20 °C)
weight	700 g (CL) / 930 g (USB)
operating temperature	+ 10 °C .. + 40 °C
operating humidity range	10 % .. 80 % (non-condensing)
storage temperature range	- 10 °C .. + 60 °C
optical interface	F-mount & C-mount
CE / FCC certified	yes

Sensor		
type of sensor	scientific CMOS (sCMOS)	
dynamic range	16 bit	
image sensor	CIS2020	CIS 2521
resolution (h x v)	2048 x 2048 active pixel /	2560 x 2160 active pixel
pixel size (h x v)	6.5 µm x 6.5 µm	6.5 µm x 6.5 µm
sensor format / diagonal	13.3 mm x 13.3 mm / 18.8 mm	16.6 mm x 14.0 mm / 21.8 mm
fullwell capacity (typ.)	30 000 e-	30 000 e-
spectral range	370 nm .. 1100 nm	370 nm .. 1100 nm

A1.5 MOUNTING

A1.5.1 INSTABLE MOUNTING

These instructions are not valid for every application. Especially in microscopy when extreme magnification is used, the smallest vibration can disturb images.



The pco.edge needs a stable mounting plate to avoid disturbing vibrations and to ensure a consistent high image quality. (images are mounting proposals).

Don't use such an instable mounting plate!

A1.5.2 CORRECT MOUNTING

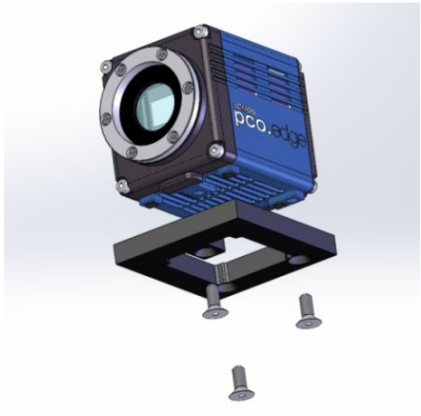

Recommended mounting.

The mounting plate must have a centred opening, as the cooling fan is located on the bottom of the pco.edge. The fan and its louvers must never be blocked.



A **stable support** for the **rear area** of the camera is very important.



Attach your pco.edge camera with three **1/4 - 20 UNC Allen screws**.



Caution:

- Mount the pco.edge on a stable plate
- Use all three mounting threads
- Never block the fan and the louvers

A1.5.3 COOLING

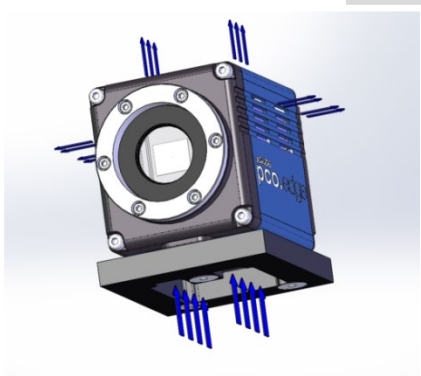

These images show the ventilation flow of the pco.edge camera.

The fan and the air intake are at the bottom of the camera. The air outlets are on top and on both sides of pco.edge.

The camera needs a sufficient supply of fresh air to reach a constant operating temperature.



Caution:

- Never block the fan and the louvers
- Keep adequate distance to other components
- Provide a sufficient supply of fresh air
- Mounting plate needs a cut-out for cooling

A1.6 REVERSE WITH CAPTION

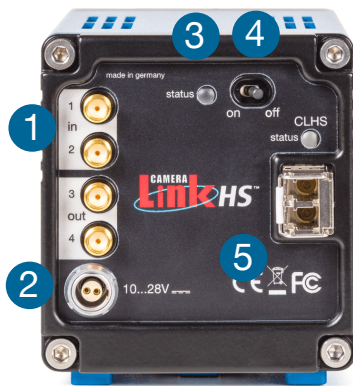

Specification of the reverse:

SMA-Jack ①

50 Ohm
Amphenol
901-143-6RFX
See Chapter 6.3.8

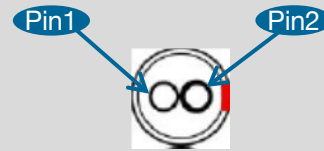

LEMO socket: ②

ECG.0B.302.CLV
Pin1: Ground; Pin2: VCC

Appropriate Lemo plug:

FGG.0B.302.CLAD52Z



Status LED ③

Red blinking:	●	error
Green continuous:	●	camera is booting
Green blinking:	●	camera is ready for operation
Yellow blinking:	●	recording on

Power switch: ④

on / off

Interface connector: ⑤

Depending on your interface: USB 3.0, CameraLink or CameraLink HS.

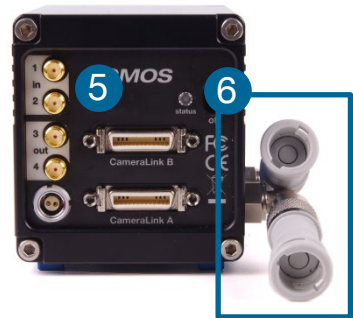

Water connectors: ⑥

Colder Product Company SM212 ¼ hose connector

A2 CHANGE FROM F-MOUNT TO C-MOUNT

Instructions on how to change the optical input from **F-mount to C-mount**:

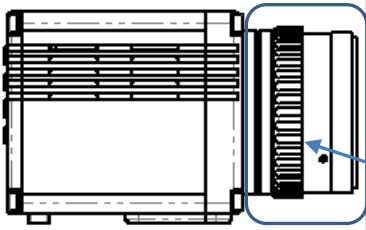

Step 1: Remove F-mount Adapter

Grasp the F-mount adapter at the blue ring (counter ring) and turn it counter clockwise.

F-mount adapter

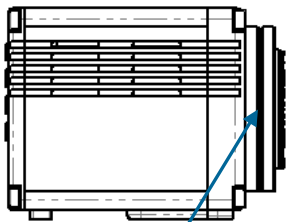

Step 2: Insert C-mount Ring

Carefully screw the ring completely in and tighten the two **Allen screws**.

C-mount ring

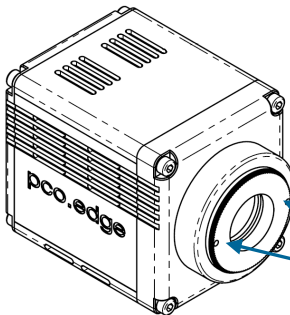
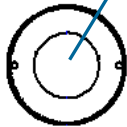

Adjust Back Focal Length

First of all, attach a lens to your c-mount adapter. Then set the focus of your lens to infinity. After that, look for a point in infinity* and generate a sharp image by turning the smaller ring of the adapter. Then fix this position with the two small indented screws.

*rule of thumb: object should be away about 2000 times the focal length in mm

Allen screws

Limitations of C-mount lenses

Keep in mind that c-mount lenses could cause shadings at the edges of big sized sensors. Most c-mount lenses are able to illuminate a maximum image circle of 11 mm (2/3"), 16 mm (1") or 22 mm (4/3") diameter only. The pco.edge cameras have a sensor diagonal from 18.8 to 21.8 mm, it follows that you have to use the ROI function for a shade less image while using the c-mount adapter with the two smaller C-mount diameters.



A3 WATER COOLING OPTION PCO.AQUAMATIC II

This is the re-cooling system for pco.edge cameras with water-cooling.

A3.1 SYSTEM COMPONENTS



	Description
1	pco.aquamatic II
2	Connection Tube 5m PVC 3541-01 PCO (with Colder NS212 fittings)
3	Power supply 1.2m
4	Power cable
5	EDGE WAT camera cable 5m FGG-RG58- NC3MX
6	Innovatec Protect IP 1L

The operation of the **pco.aquamatic** is simple and uncomplicated. Normally no maintenance and nearly no attention are needed. Only the liquid level of the reservoir (water tank) should be controlled from time to time.

Only use Innovatec Protect IP for the pco.aquamatic! Do not use or add any other cooling liquid or normal water! If you need to add cooling liquid in order to maintain level in the tank, please contact PCO for additional supply.

The cooling liquid will turn yellow after some hours of operation. This is normal and no sign of wear or malfunction. The optimum pH-value is between 8 and 9 (please check this value if you are concerned about the cooling liquid quality).

NOTE
The recommended service interval for the change of the cooling liquid is four years.

A3.2 FIRST TIME INSTALLATION



Please take care to situate the unit on a flat and firm surface. Do not cover the air intakes of the unit. Please ensure free airflow around the pco.aquamatic to ensure maximum cooling performance. All tubes and power cords need to run kink-free.

Before installation of the unit carefully read the **Innovatek Protect IP safety** datasheet (see **Innovatek Website**).



outlet flow



inlet flow

Please follow steps 1 – 6.

- 1 Connect tubes to cooling unit and camera. The two arrows on the housing of the cooling unit only indicate flow direction. Either connection of the camera can be used for **in** or **out**.
- 2 Attach power connection.
- 3 Open tank cover.
- 4 Turn power switch to **on** position (I).
- 5 Slowly fill in the cooling application mixture while the unit is running, you have to constantly refill liquid.
- 6 While the cooling liquid flows back to the reservoir make sure that the whole air escapes from the system – this takes a few minutes (move hoses if necessary).

The cooling liquid reservoir (tank) is filled when liquid level is approximately 1-2 cm from the top of the tank. The integrated pump only works when the pump chamber is completely filled. To ensure this please move hoses or remove air by evacuating. Reservoir capacity is approximately 500 ml.

After **steps 1 – 6** are completed successfully the system is ready for **operation**.

NOTE

The hose connectors are waterproof in not connected state. Maybe they lose one drop of cooling liquid from time to time. You don't have to empty the hoses while storing the camera system.

A3.3 OPERATION

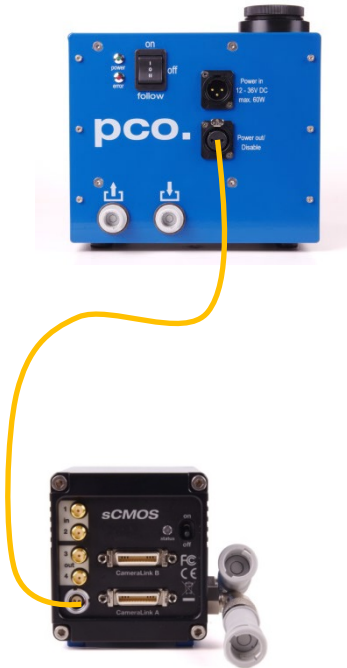

First connect the **power out** of the cooling unit with the **power in** of the pco.edge camera by using the *PCO WAT camera cable*.

The cooling unit provides two operation modes.

Operation Mode on: the cooling unit is turned on permanently and provides the camera with power. Your camera can be switched on and off as needed.





Operation mode follow: the cooling unit will turn on when the camera is switched on and vice versa.

Error Codes

The coolant temperature sensor is located in the water tank.

Temperature	Action
27°C	fan turns off
36°C	fan turns on
55°C	warning message
60°C	error message

If a **warning level** is passed, the Power LED blinks slowly and the Error LED displays the error code. If a **failure level** is passed, the Power LED blinks fast and the Error LED shows the error code.

 power	 error	Error / Failure
on	off	none
1Hz flash	one short flash	Warning when temperature at 55 °C (also if sensor is defect or missing)
2Hz flash	one short flash	Failure when temperature at 60 °C
1Hz flash	two short flashes	Fan speed (also if a high deviation of the standard value is reached)

NOTE

The camera has its own protection circuit and will shut down Peltier cooling automatically when the electronics temperature exceeds safety level. The camera itself will keep on running, but sensor temperature will increase. (valid for air and water cooling!)
If the camera and the water cooler have a different power supply, always first shut down camera and then the cooling system to avoid damages.

A3.4 DIMENSIONS

All dimensions are given in millimeter.

Weight: 4kg (completely filled cooling liquid tank)

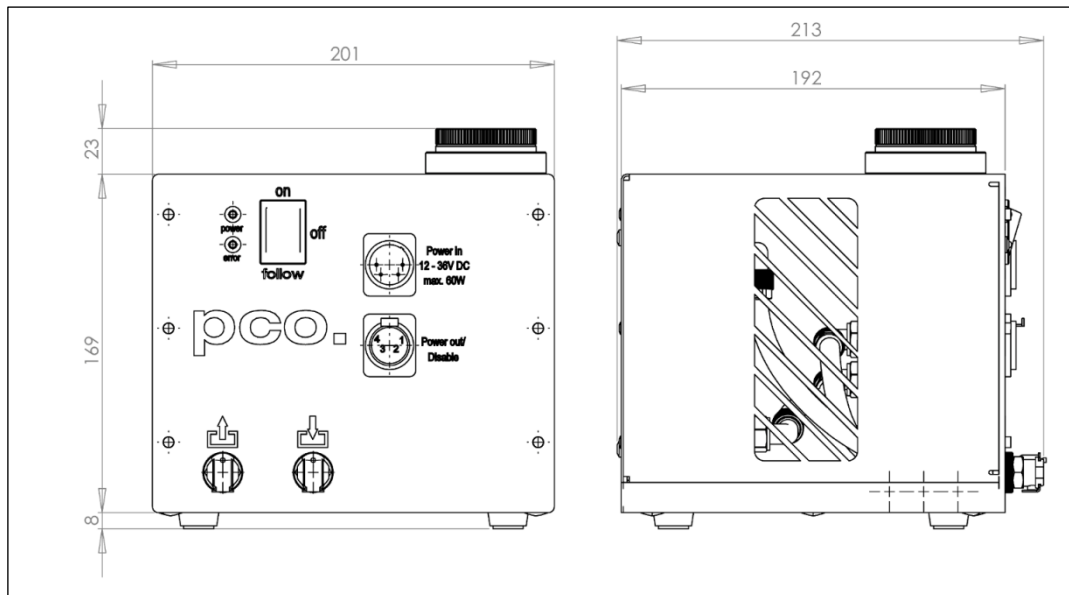

General Information

You are not restricted to purchase the pco.aquamatic system - it is possible to use an own water cooling solution. A separate power supply will be provided to every pco.edge camera with water connectors. The hardware of the pco.edge cameras with USB 3.0 Interface is designed to work with or without a water cooling system, because a fan that provides adequate cooling is inside the camera anyway.

In case you use an own water cooling system, please make sure that the liquid you use to cool your camera is at all times NEVER below the dew point of the ambient temperature! In order to avoid any appearance of condensation, use a cooling liquid at room temperature. A liquid flow rate of 1–2 litres per minute is sufficient.

A4 INTERFACES

Three different interfaces are available for the pco.edge camera. This chapter describes the installation and configuration of USB 3.0, Camera Link and Camera Link HS interfaces. Furthermore USB range extension, Ring Buffer and FIFO Buffer are described in detail.

A4.1 CABLE POSSIBILITIES

Overview of the maximum cable lengths

Camera Link full:

- standard: 3 m
- optional: 5 m
- maximum: 10 m (active cable)
- no cables are included in the camera price

NOTE

Please only use Camera Link cables, which have been approved by PCO. Otherwise full functionality is not guaranteed.

Camera Link HS

- FOL fiber optic cable: length up to 300 m with SFP+ connector

USB 3.0:

- standard: 3 m
- cable and proper PCI express board included in the camera price

A4.2 CAMERA LINK

A4.2.1 INSTALLATION OF FRAME GRABBER

Instructions for installing and testing the **Silicon Software microEnable IV (ME4)** Camera Link grabber card. This card is required to be able to use a pco.edge with Camera Link interface. Installation must be performed by a technician, because high voltages can occur on the device.



WARNING

ELECTRIC SHOCK WARNING DUE TO VOLTAGE PARTS INSIDE

Risk of injury due to electric shock.

➔ Always pull the main plug before opening the computer.

Please install the latest silicon software runtime package before installing the hardware. (Download: <http://www.pco.de/support/>)

When working on a 64 bit operating system, please make sure to install the proper (64 bit) runtime when also a 64 bit application will be operated. If the application is 32 bit, you need to install the 32 bit runtime accordingly.

- 1 Select **full installation**
- 2 Let the program also **update device drivers**.
- 3 Shutdown your computer, open the computer case and install the **grabber card**
- 4 The grabber card should be displayed within the device manager. If the device is not shown this way, please reinstall the **SiliconSoftware device driver**.
- 5 After the installation, please start the program **microDiagnostics**. (see next page)

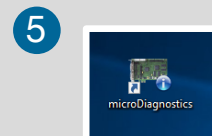
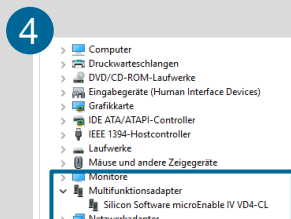
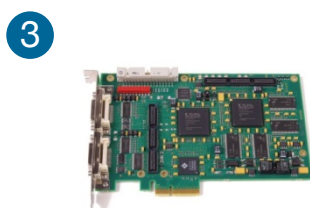
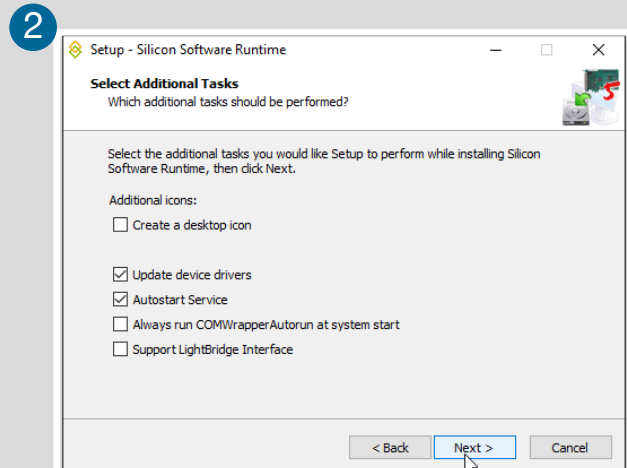
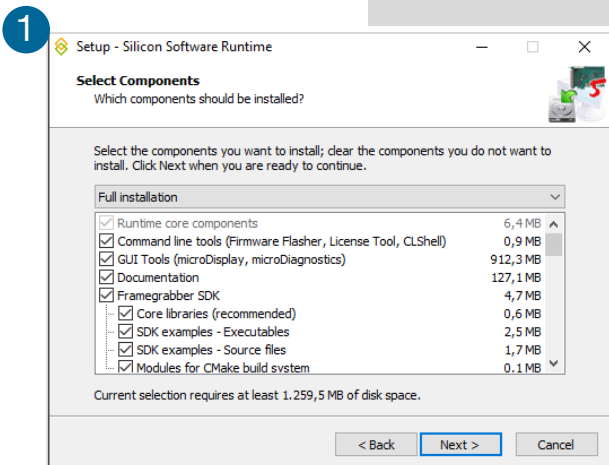

A4.2.2 MICRO DIAGNOSTICS TOOL

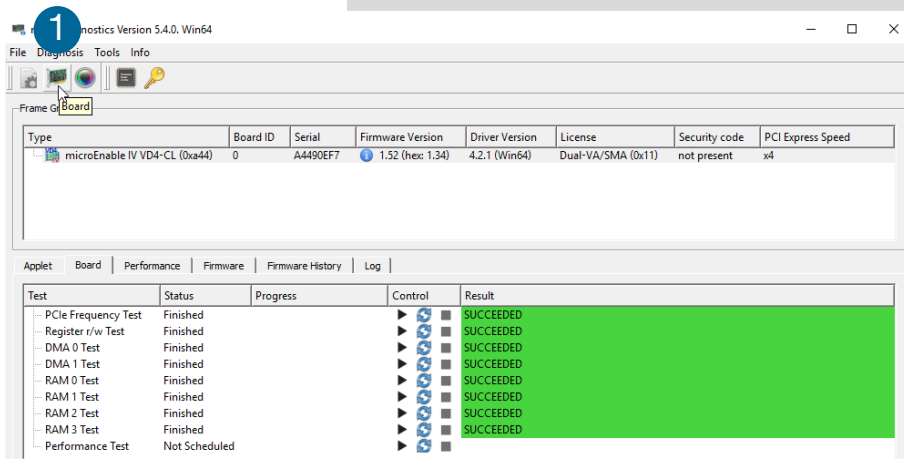

Micro Diagnostics Tool works with both meIV (AD4/VD4 for CL) and meV (CLHS) frame grabber cards.

To test the board, select the board in **Diagnosis** and click **Board 1** to start the test

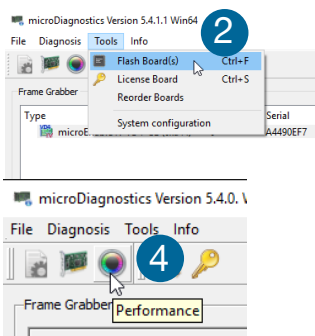

Please upgrade to the supplied firmware. Select Tools → **Flash Board(s)** and select the appropriate hap file. Micro diagnostics provides the latest available firmware version of the installed runtime.

Then click on **Yes** when you're asked to proceed. You must restart your computer after the firmware upgrade.

Please test the performance of your frame grabber card: click on **Performance** to start the test.

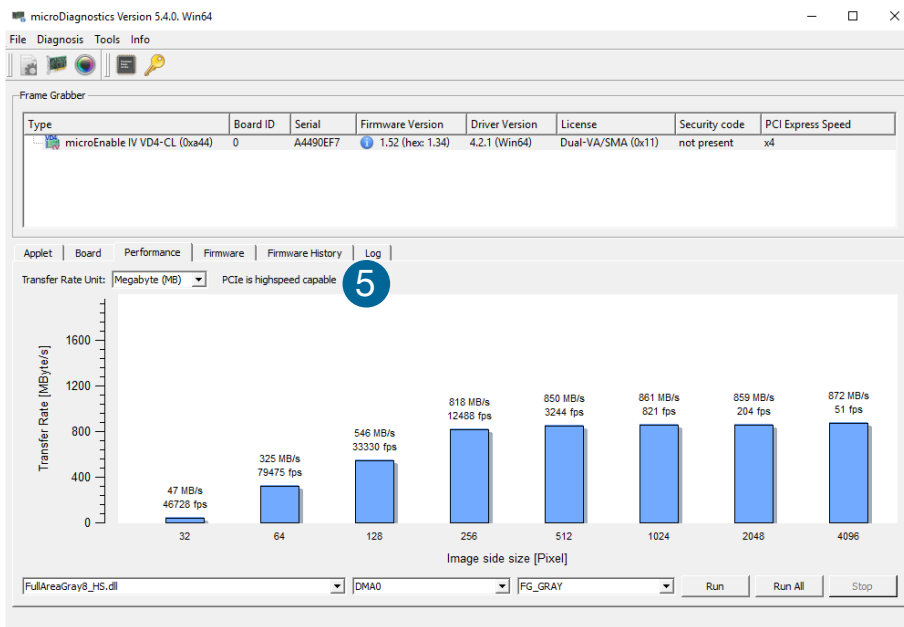

It is mandatory that **PCIe is Highspeed Capable** is shown. Otherwise the board is probably not able to transfer the necessary data rate.

For further information or problems with mainboards please contact our **support** section.

A4.2.3 IMAGE DATA FLOW

The **sCMOS image sensors** provide an extremely high frame rate compared to other scientific image sensors. The high frame rate, along with the high dynamic, creates a large amount of data that must be handled and stored. The maximum data rate of the sCMOS image sensor is given by:

pco.edge 5.5 Camera Link:

$[2560 * 2160 \text{ (pixel in 1 frame)} * 2 \text{ Byte (= 16bit dynamic)}] * 100$
[frames/s] = 1.1 GB/s (pco.edge 5.5, Camera Link)

To handle this considerable amount of data, there are **two options** available:

Option 1: Real-time Recording to Computer

The pco.edge sCMOS camera series uses this option. For this purpose, the interface must be capable of transmitting data at the required speed. Interfaces such as GigE, USB 3.0 and Camera Link are not fast enough to transmit this data, which is delivered by the largest sCMOS image sensor. Nevertheless, there is a sophisticated solution that uses the Camera Link interface, which is integrated into the pco.edge camera. It is a fact of nature that light, itself, has its own noise component called **photon or shot noise**, which increases with light signal. In this approach, no compression is made in small signals, while for large signals a suitable compression is applied. Since the introduced compression error is always smaller than the photon noise induced error, it is not seen and a so called **visual lossless compression** has been performed.

It can be shown that this is possible without any significant loss of information. Therefore, the calculation for the pco.edge camera at full speed and full frame has to be re-written:

$[2560 * 2160 \text{ (pixel in 1 frame)} * 1.5 \text{ Byte (= 12bit dynamic)}] * 100$
[frames/s] = 0.829 GB/s

The Camera Link interface can transmit this in real-time. In the future, recently introduced machine vision interfaces including CoaXPress and Camera Link HS are capable of transmitting sCMOS image data without any compression. A network type interface, 10GigE, is similar with respect to hardware to Camera Link HS, but incorporates all of the known GigE advantages and disadvantages. Here, the usual protocols are not favorable for image data transmission, and any network traffic can dramatically reduce available transmission speed.

The real-time data transmission into the computer allows for a variety of applications, since it is free from camera memory limitations. Image data can be stored directly in the computer's random access memory (RAM) up to more than 64 gigabyte. With an appropriate RAID system, the data can be stored directly to hard disks and there is no delay involved.

Option 2: Recording in the Camera

For high-speed imaging applications where data transfer rates are in the range of several GB/s it is accepted that the primary image memory (camRAM) must be located in the camera. Two examples of

such high-speed cameras are the pco.dimax with 36 GB of camRAM and the pco.dimax HD with 18 GB of camRAM memory. This allows for fast recording, but just up to the integrated memory limit. Before a second sequence can be recorded, one must endure the wait time until data is downloaded to computer storage. Therefore, this option can only be used for recording short sequences with enough time between each event to download the image data. This option is not necessary for the pco.edge as either with USB 3.0 or Camera Link interface, the image data will be recorded to the computer in real-time.

Memory Structure / Organization

As the memory is software-controlled in both options, it does not matter how the data is stored. The memory can be organized for ring buffer or FIFO recording, or for a specified number of images like a burst mode. The pco.edge camera enables all of these possibilities with the integrated dynamic link libraries and proprietary Camware application software. This allows the customer to select the memory structure and organization that is optimized for the application at hand.

Recommendations

In the following you can find two exemplary systems for RAID and RAM storage options that have been successfully tested by pco for high performance **and which we sell directly to our customers**. They only show a configuration example, for actual system configuration please call us directly.

RAID 0 SYSTEM

4x SSD SATA 6 GB/s
16 GB DDR3 RAM
Intel® Core™ i7
GeForce (NVIDIA CUDA)
Windows 7 Professional 64 bit

RAM RECORD ER

64 GB DDR3 RAM
Intel® Core™ i7
GeForce (NVIDIA CUDA)
Windows 7 Professional 64 bit

NOTE

Items are exemplary and subject to change. Please contact PCO for recommendation of current systems and sale of these systems. The use of normal consumer PCs is not recommended!

ASUS mainboards seem to fail generally during the HS-mode test and are not recommended.

Recommended minimum configuration (or better):

- CPU \geq i7 2.5 GHz
- RAM \geq 1066MHz, 8GB
- Mainboard \geq Supermicro X9SRA (socket 2011)

A4.3 CAMERA LINK HS



WARNING

CLASS 1 LASER PRODUCT

Risk of injury due to laser beam.

- Do not look into the laser beam or at direct reflexes.
- Do not point the laser beam at persons.
- Manipulations of the laser device are not allowed.

ELECTRIC SHOCK WARNING DUE TO VOLTAGE PARTS INSIDE

Risk of injury due to electric shock.

- Always pull the main plug before opening the computer.

Your pco.edge CLHS is delivered with a Silicon Software **microEnable V marathon AF2** frame grabber card.

The **installation and configuration** of the frame grabber card is identical to the CameraLink mE IV card: see **A4.2.1**

Minimum system requirements:

- PCI Express x4 (Gen 2), DMA1800
- DDR3 Ram \geq 8GB

Short installation instructions:

- Install frame grabber card to your computer
- Install driver of your frame grabber card
- Connect your pco.edge CLHS to frame grabber card
- Start your camera
- Run Camware

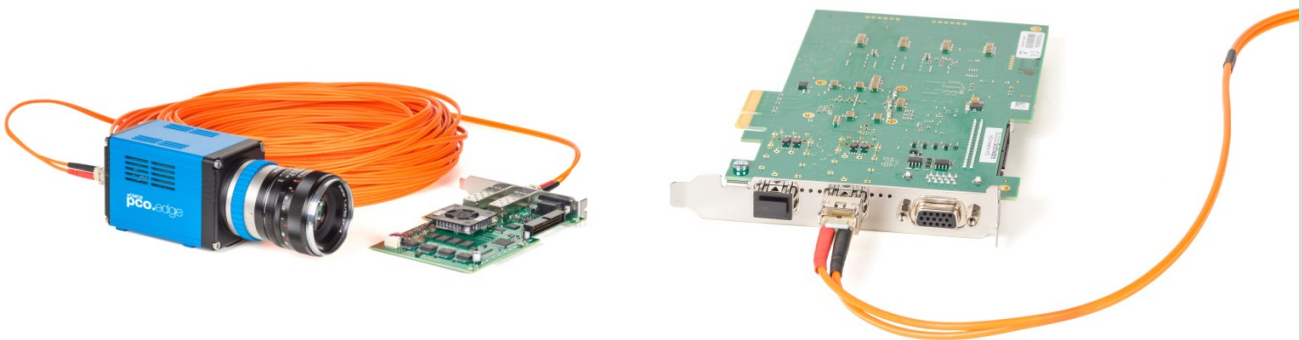

Camera Link HS specifications:

- more bandwidth - up to 1187 MB/s
- more robust connection - no communication error with Forward Error Correction (FEC) and Fiber Optic Link (FOL)
- more distance - 300 m with multi mode fiber and SFP+ connectors
- more open - full CLHS specification is downloadable for free
- more cost effective - use of standard network hardware components allows multi sourcing

A4.4 USB 3.0

A4.4.4 DRIVER INSTALLATION

Install PCO USB 3.0 Driver

For pco.edge USB 3.0 you always need to install the latest **USB Driver version**. After these two screens **1** **2** the driver is completely installed.

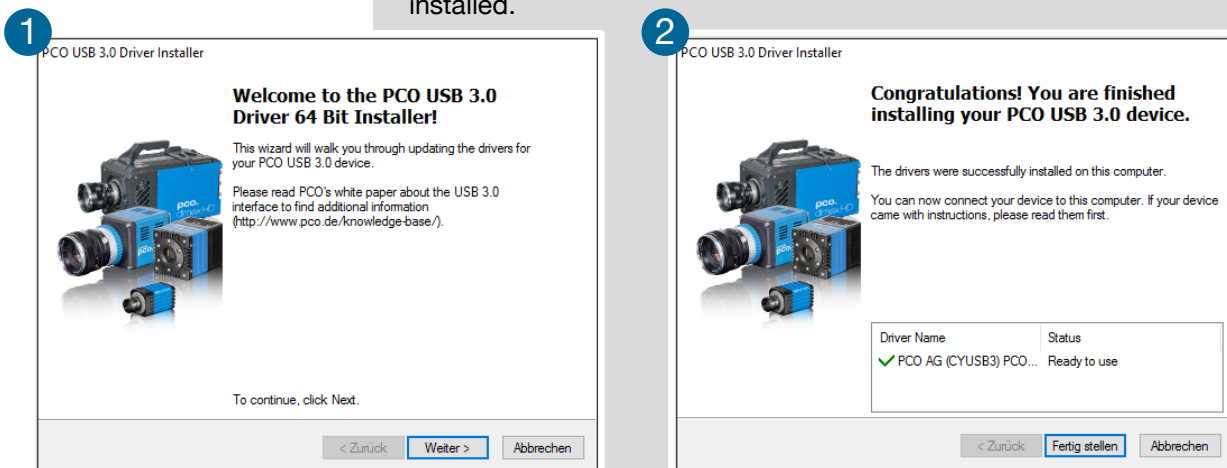

A4.4.5 HARDWARE RECOMMENDATIONS

The pco USB 3.0 interface is based on the Cypress EZ-USB FX31 device and it is compatible to pco software such as Camware and SDK. To run a pco USB 3.0 camera successfully the user should consider a number of important issues that are discussed in the following chapters.

Motherboard and Chipset Configuration

It is recommended to use a Motherboard with a state of the art USB 3.0 host controller for the onboard USB 3.0 ports. The latest generation of USB 3.0 xHCI host controllers manufactured by Intel, Renesas (NEC), Fresco, Via Labs, ASMedia and Texas Instruments Inc. (TI) are tested by Cypress Semiconductor Corporation. (see Cypress EZ-USB® FX3TM SDK Release Notes, Version 1.2.3, chapter 1.3). Currently pco recommends only motherboards with the following onboard xHCI host controllers:

- Renesas/NEC μ PD720202 Host Controller
- Intel® USB 3.0 eXtensible Host Controller

If the motherboard does not have an onboard USB 3.0 port or the onboard USB 3.0 port does not work properly with a pco USB 3.0 camera, **please use an independent PCIe USB 3.0 extension card**. In this case, pco recommends the following:

- DELOCK 89348 (U3-PCIE1XG202-10)
PCIe x1 Gen/V 2.0 (μ PD720202 host controller)
(This board is sent with your pco.edge USB 3.0 camera system as standard)
- DELOCK 89325 (U3X4-PCIE4XE101)
PCIe x4 Gen/V 2.0 (μ PD720202 host controller)

USB 3.0 extension card with xHCI4 host controller

The following companies manufacture USB 3.0 xHCI host controller:

- Renesas Electronics America Inc. (earlier NEC),
- Texas Instrument Inc.,
- VIA Labs Inc (Diamond),
- Fresco Logic Inc.,
- Intel Inc.,
- AMD Inc. and
- Etron Technology, Inc.

NOTE

To determine suitable manufacturers of the xHCI controller, please use the Windows Device Manager. For example, in Windows 7 drop down the USB Controller entry and find the USB 3.0 host xHCI controller of the USB 3.0 device in the sub-tree. Then right-click to open the properties dialog, click the **details** tab, and choose **Vendor** in the properties pull-down box.

NOTE

USB 3.0 interface cards with controllers from **Etron** Technology, Inc. have not yet been tested.

The following table gives an overview about tested and recommended system configurations or hardware components.

Component	Recommendation
Motherboard	There is no recommendation for a manufacturer. But if an onboard USB 3.0 port is used, the Renesas's xHCI host controller μ PD720202 is recommended.
USB 3.0 extension card	<ul style="list-style-type: none">• DELOCK 89348 (U3-PCIE1XG202-10) PCIe x1 V2.0 (μPD720202 host controller),• DELOCK 89325 (U3X4-PCIE4XE101) PCIe x4 V2.0 (μPD720202 host controller)
PCIe Slot	A PCIe 4x, 8x or 16x slot is recommended.
USB 3.0 Cable	USB 3.0 cable included in the packaging of your pco USB 3.0 camera
USB 3.0 Hub	Not recommended
Operating System	Win 7 / 8 / 10 32bit & 64bit
Multiple pco USB 3.0 cameras connected to a PC	A separate DELOCK 89348 (U3-PCIE1XG202-10) extension card for each camera should be used to guaranty maximum data throughput of each camera.

Recommended Software Components

The pco USB 3.0 driver supports Windows 7/8 (x86 or x64) and Windows XP x86 operating systems. Microsoft does not support USB 3.0 natively for Win 7 or older Windows versions. Therefore use the manufacturers' supplied xHCI host controller driver. By contrast, in Windows 8 Microsoft does provide a native generic xHCI Driver but pco recommends using the driver from the corresponding manufacturer of the xHCI host controller. Currently there are seven different vendors producing USB 3.0 host controllers:

- Renesas Electronics America Inc. (earlier NEC)
- Texas Instrument Inc.
- Intel Inc.
- VIA Labs Inc (Diamond),
- Fresco Logic Inc.
- AMD Inc.
- Etron Technology, Inc.

Please make sure that the most recent driver from the manufacturer is installed before a pco USB 3.0 camera is connected to a USB 3.0 port of your computer. The appropriate driver for the USB 3.0 port could be loaded from the website of the manufacturer of the USB 3.0 host xHCI controller; or from the website of the USB 3.0 extension card vendor. The current driver of the extension card included in the packaging of your pco USB 3.0 camera is added to the **pco.USB stick** delivered with each pco.edge.

NOTE

To determine the driver currently in use for the xHCI controller, use the Windows Device Manager. For example in Win 7, drop down the USB-Controller entry and find the USB 3.0 host xHCI controller of the USB 3.0 device in the sub-tree. Then right-click to open the Properties dialog, click the driver tab and choose driver details

Before the pco.edge USB 3.0 camera is connected to the computer the pco USB 3.0 Driver has to be installed. (see 4.1) Please visit the support section of our website to get the latest USB 3.0 camera driver.

A4.4.6 USB 3.0 FAQ

Can I use USB 2.0 PC components?

If the USB Port, the USB Cable, or the USB Hub does not support USB 3.0, a USB 3.0 PCO camera will not operate properly. The camera will be recognized in the Device Manager as a USB 2.0 device. Operation of the PCO camera using Camware or one of the PCO SDK camera related functions will fail and the following message box will appear: "Please make sure your camera is connected to a USB 3.0 port. If your camera is connected to a USB 3.0 port, please read the application note APL_USB3_xxx.pdf".

How to identify the manufacturer of the USB 3.0 host controller?

If a driver for the onboard USB3.0 port or an independent PCIe USB 3.0 interface card is already installed, open the Windows Device Manager. Then extend the 'USB-Controller' entry and find the USB 3.0 host controller of the specific USB 3.0 device in the sub-tree. Right click to open the Properties dialog and then click the 'details' tab which will allow you to identify the correct manufacturer of the USB 3.0 controller.

Why can't the PCO USB 3.0 camera be opened with Camware or the PCO SDK?

In case a PCO USB 3.0 camera is connected to your PC and the Camware software starts in **Demo Mode**; or, the Camera Open Function of the PCO SDK returns an error, the explanation could be: The PCO USB 3.0 driver is not installed to your system and the PCO USB 3.0 device is listed as "unknown device" in the Device Manager.

If so, right click the **unknown device** to open the properties dialog and install the PCO USB 3.0 driver. The driver can be downloaded from our website at <http://www.pco.de/drivers/>. If the PCO USB 3.0 driver is properly installed, there will be a **PCO cameras** entry with a 'pco.camera with USB 3.0' device listed in the Device Manager. — Another issue could be that the USB 3.0 camera is not recognized by the OS and it does not appear in the Device Manger, meaning it is even not shown as 'unknown device'. In this case please refer to Chapter 4.1 and follow the instructions provided.

Why was the PCO USB 3.0 camera not recognized by the OS?

There could be a problem with the USB 3.0 xHCI host controller of the Motherboard or with the extension card installed in the PC. Additionally, a bad USB 3.0 cable could be the problem.

How to increase the performance of the USB 3.0 data transfer?

To make sure the full data-throughput of the camera can be transferred to the PC's RAM, it is recommended to use a PCIe 4x, 8x or 16x slot in the PC.

In the case of using Windows 8, poor performance could be caused by the Microsoft's automatically installed generic xHCI USB 3.0 driver. In this case please load and install the driver of the manufacturer's xHCI host controller.

If more than one PCO USB 3.0 camera is operated on a single PC, please note that extension cards have maximum bandwidths that are exceeded with two or more cameras.

There exists a maximum bandwidth of an extension card, e.g. if the DELOCK 89348 (U3-PCIE1XG202-10) PCIe 1x card is connected to a PCIe 16x slot of the PC the effective bandwidth is about 360 MB/s. If two PCO USB 3.0 cameras are connected to both ports of the extension card, the accumulated data throughput of both cameras cannot exceed this 360 MB/s maximum. In this case it would help to use a second DELOCK 89348 (U3-PCIE1XG202-10) PCIe 1x card connected to a second PCIe 16x slot of the PC for the second PCO USB 3.0 camera.

How many PCO USB 3.0 cameras can be connected to and operated with one PC? How many PCO USB 3.0 cameras are supported by the PCO USB 3.0 driver?

The PCO USB 3.0 driver supports up to eight cameras using one PC

The USB 3.0 PCO Driver Installer does not work.

The installer will return a warning that the current OS is not supported. The installer supports the 32-bit and 64-bit versions of Windows 7 and Windows 8.

If the installer file is executed and a no dialog window appears: Please try to install the driver manually using the Windows Device Manager. Contact our support team to get the driver files for manual installation.

The driver is correctly installed, but the USB 3.0 PCO camera does not appear in the Device Manager:

Make sure the PCO USB 3.0 camera is ready, the power switch is turned on, and the camera is connected to the PC.

Note that while installing the camera to the PC that during the USB 3.0 driver installation it could take a minute or more until the PCO USB 3.0 device recognized and is available for use.

A4.4.7 INSTALLATION OF THE USB 3.0 CARD



WARNING

An external USB 3.0 Host Controller Card is enclosed to each pco.edge USB 3.0 camera.

Hardware Installation

First shut down your computer and install the USB 3.0 Host Controller. Hardware Installation must be performed by a technician, because high voltages can occur on the device.

ELECTRIC SHOCK WARNING DUE TO VOLTAGE PARTS INSIDE

Risk of injury due to electrical shock.

➔ Always pull the main plug before opening the computer.

Driver Installation Instructions

- Within the provided installation files **USB_HBA**, open the folder U3X4-PCIE4XE101, U3X4-PCIE1XE101, U3-PCIE1XG202.
- Open the subfolder Driver and run RENESAS-USB3-Host-Driver-30230-setup.exe.
- If your current OS is Win7/8 and the User Account Control is enabled, a dialog could occur asking, if you wish to launch the setup: Accept with **Yes**.

- 1 At first the installation is prepared.
- 2 Secondly the software components are copied automatically.
- 3 Finally the installation is completed and the **Delock USB 3.0 extension card** can be used.

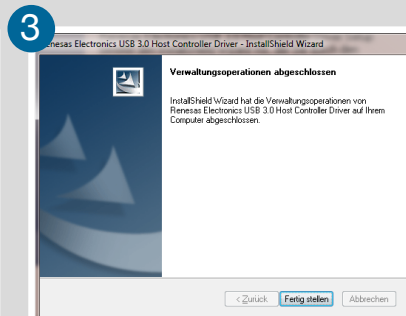
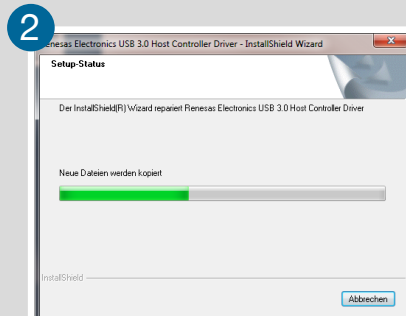
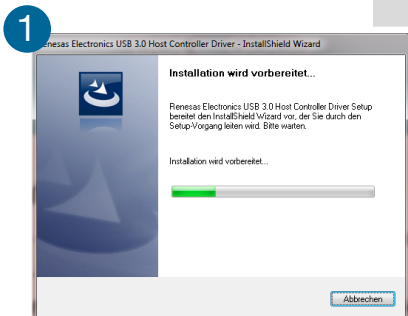

A4.4.8 RING BUFFER AND FIFO

Compared to the pco.edge cameras with Camera Link interface, the pco.edge with USB 3.0 interface has a small **internal buffer memory integrated**. Each recorded and read out image is directly transferred to this internal buffer and subsequently the image is transmitted to the computer, where it is either stored into the RAM or onto the hard disk drive. There are two transfer modes available: Ring Buffer and FIFO buffer which can be accessed via SDK function: **PCO_SetStorageMode** (see SDK manual).

From user perspective the main difference between both modes occurs, if for some reasons the USB 3.0 interface behaves **slower** than its usual speed. In this case the Ring Buffer delivers faster the most recent image than the FIFO Buffer mode, which can be helpful for example if the image should be focused.

Ring Buffer (in camera memory–standard mode)

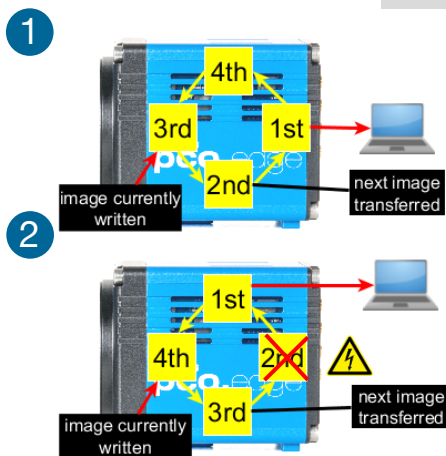

As described the read out and recorded image is directly transferred into the internal buffer memory. Subsequently the next image is stored to the next free space. For the transmission from the camera to the computer **always the most recent image** is used, which works fine in case the computer does not do anything else than transfer images to its internal storage memory (RAM). ①

Now, if the transmission speed of the computer system is interrupted by e.g. software, it can happen that images get lost, because in Ring Buffer mode the most recent image has to be transmitted to the PC. In case of a delay in transmission, the image in the memory, which waits for transmission **will lose its status as most recent image** to the next image, and will be disregarded for transmission. Hence this image will be **irretrievably lost**. ② Because Ring Buffer always transmits the most recent image and therefore the most real-time transmission, it is the ideal mode for e.g. adjustment of focus.

FIFO Buffer (in camera memory)

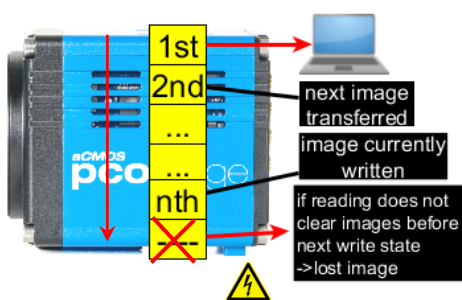

Like above the read out and the recorded image is directly transferred into the internal buffer memory. Subsequently the next image is stored to the next free space in memory. If all the memory space is occupied the **camera stops storing**. In FIFO buffer mode like name stated, FIFO = first-in first-out, the first stored image is read-out from the memory first and subsequently transmitted to the computer. This as well works fine in case the computer does not do anything else than transfer of images to its internal storage memory.

Now, if the transmission speed of the computer system is interrupted by e.g. software, then still the first stored image is readout, and then the next image is read out and transmitted. However there could be a delay time (but need not). If now the slowdown causes the FIFO buffer to be completely filled, then the camera stops storing images and the next image will **irretrievably lost** as well, but in this mode it is **lost before storing**. This mode is ideal for users who need maximum transmission security; an image loss is very unlikely.

A5 BINNING WITH CMOS SENSORS

Binning describes the summation of single pixels to form larger pixels and thereby improve the signal-to-noise ratio (SNR).

Binning: CCD image sensors

The term binning comes from scientific CCD image sensors. The prominent feature of charge-coupled-devices (CCD) is the lossless transport or shifting of charge packages until an amplifier circuit converts them into a voltage at the output, where the main readout noise contribution occurs. If charge packages from two or more pixels are added before they are read out (past the output amplifier) because of very low light signals; this process is called binning. Since the signal is increased before it is read out, and the image sensor's readout characteristics remain unchanged, binning improves the SNR, and the image sensor's resolution is reduced. The lossless transport feature of CCD image sensors makes binning possible.

Binning: CMOS image sensors

In general, binning is not possible in CMOS image sensors because voltages are processed and no charges are transported. In each pixel, the light generated charges are converted into voltages with the readout noise contribution of these amplifiers. Therefore, as opposed to CCD image sensors, if these voltages were combined, the readout noise would also be combined, which would not have the same positive effect on the SNR.

Nevertheless, such a summation or even an averaging would be beneficial for the SNR, but with a smaller impact compared to CCD image sensors. Since such **CMOS binning** cannot be done within the image sensor, it either has to be done in the camera or in the computer.

CMOS binning 1 – accumulation: Pixel values can accumulate, causing an effective dynamic reduction or larger number formats, because the result might exceed the original format -- two times maximum 8 bit values will result in a 9 bit value. This will not be a problem if 12 bit values are accumulated and transported as 16 bit images. However, in the case of scientific CMOS, if 16 bit values are transmitted in 16 bit images, only two times 15 bit maximum values are allowed. The signal of the binned pixels will be accumulated. Due to the properties of readout noise; the increase of the noise itself will only be as big as the square root of the number of binned pixels. The SNR will improve and in addition, a reduction of the stored image data is achieved.

CMOS binning 2 – averaging: Pixel values can be averaged, which has the same effect on the SNR as accumulation due to the properties of noise. This would keep the image output format the same and would reduce the amount of image data that can be stored. When this type of **CMOS binning** is processed in the camera it is called **hardware binning**. This should not be confused with real binning in CCD image sensors, because the **hardware** that processes this binning is not much different from the **hardware** in computer processing. Therefore, the term **hardware binning** may be misleading.

NOTE

The current default binning mode is accumulation. Averaging is not available within Camware.

A6 LIGHTSHEET SCANNING MODE

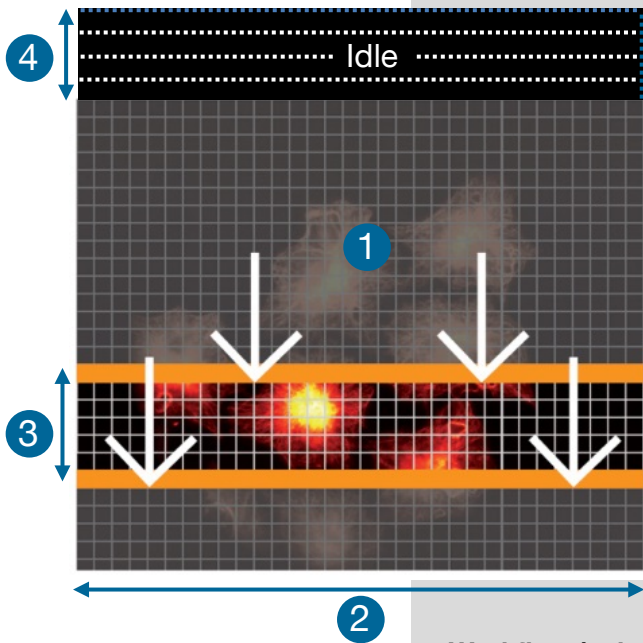

The pco.edge **Lightsheet scanning mode** is a special mode for lightsheet microscopy and only available for **Camera Link** versions via SDK (not in Camware).

It is based on Rolling Shutter mode and uses the readout mode **single top down (Mode E** see 6.9.3). ①

Standard line time value is **40 μ s** ② and it can be set from camera specific line time (see p.6) up to 100 ms. An **exposure area** (between the orange bars, e.g. **five lines** ③) can be user defined. It is possible for the user to select the number of lines and the exposure time per line.

This user-defined capability makes it possible to synchronize the pco.edge cameras with a lightsheet microscope that requires this method of camera exposure timing

Workflow (only PCO SDK)

- Set **Rolling Shutter** mode
- Set readout format **E** ①
- Set **line timing on** (0x0001 \triangleq a CMOS_LINETIMING_PARAM_ON see sc2.defs.h) and set the appropriate line time ②
- Set **number of exposure lines** ③
- Set **number of delay lines** ④
- Trigger mode and acquire mode and hwio settings are free to select by the user

SDK settings: (see SDK manual)

SC2_SDK_FUNC int WINAPI PCO_SetCmosLineTiming	wParameter ② wTimeBase (e.g. μ s ②) dwLineTime (e.g. 40 ②)
SC2_SDK_FUNC int WINAPI PCO_SetCmosLineExposureDelay	dwExposureLines (e.g. 5 ③) dwDelayLines (e.g. 4 ④)

A7 IMAGE FILE FORMATS

There are different file formats available for saving camera images with Camware.

b16

The b16 16 bit format is similar to the bmp format. However, 16 bit pixel values are used instead of 8 bit pixel values.

The file format consists either of a Basic Header (6 Long-parameter) or of an Extended Header (32 Long-parameter), the latter of which is optionally for additional information. There might follow a variable comment field (ASCII code). Finally, there is the actual data set that is saved linearly (as in the case of BMP files).

With the exception of the first value, all parameters are Long Integers (4 Byte). The first 6 parameters must always exist. The rest of the parameters, as well as the comment field, are optional.

	Parameter	Function
1	pco-	the first 4 byte are the characters pco-
2	file size	file size in byte
3	header length	header size + comment filed in byte
4	image width	image width in pixel
5	image height	image height in pixel
6	extended header	-1 (true), extended header follows
7	color mode	0 = black/with camera, 1 = color camera
8	b/w min	black/white LUT-setting, minimum value
9	b/w max	black/white LUT-setting, maximum value
10	b/w linlog	black/white LUT-setting, 0 = linear, 1 = logarithmic
11	red min	red LUT-setting, minimum value
12	red max	red LUT-setting, maximum value
13	green min	green LUT-setting, minimum value
14	green max	green LUT-setting, maximum value
15	blue min	blue LUT-setting, minimum value
16	blue max	blue LUT-setting, maximum value
17	color linlog	color LUT-setting, 0 = linear, 1 = logarithmic
18 ... 266	internal use	

Comment file in ASCII characters with variable length of 0...XX.
The length of the comment filed must be documented in the header length field.

	16 bit pixel data
line 1, pixel 1	value of the first pixel
line 1, pixel 2	value of the second pixel
...	...

We recommend that all images should be saved first in the b16 or TIFF format. The advantage is to have the b16 or tiff images available all the time. You will always have the maximum 16 bit information. Please note that not all image analysis programs can accommodate 16 bit data. The 8 bit format saves only the information displayed on the monitor screen. The 16 bit information will be lost and cannot be displayed later.

pcoraw

This 16 bit pco file format is based on the new BigTIFF format, thus allowing for file size > 4GB. A new pco proprietary compression scheme is added in case it is necessary.

Standard File Formats**TIFF**

Tag Image File Format, version 6.0 and lower. There is a 16bit monochrome and color image format.

BMP

Windows Bitmap Format, b/w or color 8 bit format-images, which have been saved in BMP format can be loaded later only as 8 bit images, i.e. part of the original information (16 bit) is lost.

FTS

Flexible Image Transport System, Version 3.1. This is a 16 bit image format. The NASA/Science Office of Standards and Technology (NOST) has defined this format. Some programs use the FIT extension for this format.

ASCII

16 bit format, some mathematical programs prefer ASCII data.

JPG

JPEG (named after the Joint Photographic Experts Group who created the standard) is a commonly used method of lossy compression for photographic images. The degree of compression can be adjusted, allowing a selectable tradeoff between storage size and image quality.

JP2

JPEG 2000 is a wavelet-based image compression standard and coding system. It was created by the Joint Photographic Experts Group committee in the year 2000 with the intention of superseding their original discrete cosine transform-based JPEG standard (created 1992).

AVI

Audio Video Interleave is a multimedia container format introduced by Microsoft in November 1992 as part of its Video for Windows technology.

MPG

MPEG-1, similar to JPEG, is a standard for lossy compression of video and audio developed by the Moving Picture Experts Group (MPEG).

WMV

Windows Media Video (WMV) is a compressed video compression format for several proprietary codecs developed by Microsoft. The original video format, known as WMV, was originally designed for Internet streaming applications, as a competitor to RealVideo.

A8 CUSTOMER SERVICE

A8.1 SERVICE

The camera is designed to operate with no need of special adjustments or periodic inspections.

A8.2 MAINTENANCE



CAUTION

UNPLUG CAMERA BEFORE CLEANING

Risk of injury due to electric shock!

- Unplug the camera from any power supply before cleaning it.

NOTICE

CLEANING

- Use a soft, dry cloth for cleaning the camera.
- Do not clean the input window unless it is absolutely necessary.
- Be careful and avoid scratches and damage to the input window surface.
- Do not use liquid cleaners or sprays.

NOTICE

LENS CLEANING

- The lens is best cleaned with pressurized air or with liquid cleaners such as pure alcohol or with special optical cleaners that are available at high quality photo stores.
- Use a cotton swab dipped in pure alcohol or optical cleaning liquid and wipe only on the glass surface.
- Do not get any cleaning liquid on the metallic parts such as the lens thread, because tiny detached particles may scratch the surface.

NOTICE

CLEANING LIQUIDS

Aggressive cleaning liquids can damage your camera.

- Never use aggressive cleaning liquids such as gasoline, acetone, spirits or nitro cleanser.
- Every time the input window is cleaned, there is the possibility of surface damage.

NOTICE

PROTECTIVE CAP

Always store the camera with the protective cap or with a lens mounted to avoid dust and dirt on the input window.

A8.3 RECYCLING



If you want to dispose your camera, please **send it to PCO** or take it to a local **recycling center**.

The camera includes electronic devices, which can contain materials harmful to the environment. These electronic devices must be recycled.

A8.4 TROUBLE SHOOTING

If you have a question, which is not adequately addressed in this manual, please contact **PCO** or your **local dealer**.

To speed your request, we need the following information:

Short description of the problem	Operating system (PC)
Description of your application	Processor type (PC)
Camera settings	Memory
Type and version of camera	Graphic card
Software being used	Graphic card setup
Camera serial number	

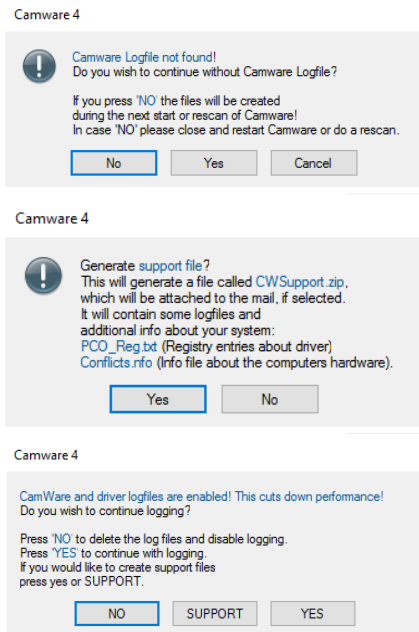
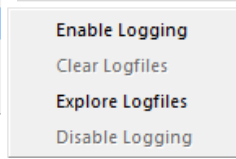
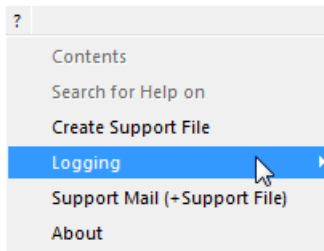

How to create a logfile:

Enable log files:	? Help Menu → Logging → Enable Logfile → Camware will ask you to press NO to activate Logfiles after restart of Camware
Repeat	the workflow which produces the faults
Open the Help Menu	Click Support Mail (+ Support File) → Camware will ask you: Generate support file?
Save this file	(CWSupport.zip – don't rename it) and send it to PCO Support (support@pco.de)
Or visit our website:	http://www.pco.de/support/ and upload the support file with our support form

Repair

Before sending the camera for **repair**, **first contact** your local dealer or **PCO** respectively.

When shipping the camera for repair, be certain to carefully pack the camera with proper shipping materials. If possible use the original packaging. Use the protection cap to protect the camera on the lens thread.

Firmware, Software and Driver Update

You will find all necessary software and drivers on the accompanying USB storage device.

For the latest versions please check our website:

<http://www.pco.de/support/supportProducts/scmos-cameras/>

A9 INDEX

NOTE:

The mentioned page is always the starting page of a chapter!

Key word	Chapter	Page
Acquire mode	6.3.7	31
Aquamatic	A3	57
Averaging	6.5	38
Binning	6.3.5, A5	28, 73
C-mount conversion	A2	56
Cable lengths	A4.1	61
Camware software	6	13
Camera Link	A4.2	62
Camera Link HS	A4.3	66
Connection options	6.3.8	33
Contrast settings (Convert control)	6.3.9	35
Demo mode (Camware)	6.9.1	42
Dimensions	A1	51
Direct record to file	6.9.2	43
Double image mode	6.3.6	30
Driver installation	4.1	9
Global Reset	6.3.4	26
Global Shutter	6.3.3	23
IIR Lowpass filter	6.5	38
Image Overlay	6.4	37
Infotext of recorded images	6.9.1	42
Input / Output possibilities	6.3.8	33
Interfaces	A4	61
Logfiles	6.9.7	47
Lightsheet scanning mode	A6	74
Live preview	6.2	14
Rear connections	A1.6	55
Recorder modes	6.3.7	31
Recorder	6.5; 6.7	38; 40
Recorder memory settings	6.2	14
Region of interest (Sensor)	6.3.5	28
Rescan for cameras	6.9.3	44
Ring Buffer	6.3.7; A4.4.8	31; 72
Rolling Shutter	6.3.2	19
Safety instructions	2	7
Save / Open / Print files	6.9.2	43
Settings Overview	6.8	41
Sequence trigger mode	6.3.7	31
Short cuts	6.9.9	49
Support file	6.9.7	47
Time stamp	6.3.7	31
Timing	6.3.1; 6.3.2; 6.3.3; 6.3.4	16; 19; 23; 26
Trigger Mode	6.3.1	16
USB	A4.3	66
Water cooling	A3	57
White Balance	6.9.9	49

ABOUT PCO



pco.

In 1987, PCO was founded with the objective to develop and to produce specialized, fast and sensitive video camera systems, mainly for scientific applications. Meanwhile the product range of PCO cameras covers digital camera systems with high dynamic range, high resolution, high-speed and low noise, which are sold in the scientific and industrial market all over the world.

Currently PCO is one of the leading manufacturers of scientific cameras. Worldwide representatives, together with our own sales department and technical support assure that we keep in touch with our customers and their needs. The actual wide range of specialized camera systems is the result of technical challenge and product specific know-how. A design according to advanced techniques, a high standard of production and strict quality controls guarantee a reliable operation of the cameras. Our own developments in conjunction with an excellent contact to leading manufacturers of image sensors ensure our access to state-of-the-art CCD- and CMOS-technology for our cameras.

Since 2001, PCO is located in its own facility building in Kelheim at the shore of the beautiful and international river Danube. Here in the county Bavaria, which is well known for its excellent support and conditions for high technology companies, we share the benefits of the simple access to high performance products and services in the surrounding area.

Kelheim itself is a historical town, first documented in 866. The small city is founded at the confluence of the Danube and the Altmühl, which has been converted into the Rhine-Main-Danube bypass channel for water transport. Located in Danube-valley, it is the heart of a beautiful river and forest covered lime plateau landscape. It's landmark, the Hall of Liberation, was built by Ludwig I. in 1863 on the Mount Michael and is visible from all over the city and valley. The beautiful Danube-Gorge, which is protected as natural monument since 1840, is located between Kelheim and the famous abbey Weltenburg.

pcó.