

7 Tesla SQUID Magnetometer

With Linear Motor Facility



S700X - For better magnetic measurements

Key Features

- Superconducting Magnet to 7 Tesla
- 10^{-8} EMU sensitivity for total moment
- Continuous operation from 400 K down to 1.6 K
- Variable Temperature Sample Space of 9 mm with He-4 Gas
- millitesla field resolution
- Electronics Rack
- LabVIEW® operating software
- Fast sample change

Options

- AC and DC measurements
- Oscillator and extraction mode
- He-3 for temperatures down to < 300 mK
- Oven option to 700 K
- Optical fibre illumination
- Pressure cell
- Transverse field
- Full environmental Shielding

The Cryogenic S700X SQUID Magnetometer instrument is suitable for the measurement of magnetic properties as a function of magnetic field and temperature. Numerous different experiments may be performed with this unique instrument.

The state-of-the-art system is the product of more than 20 years development and is fully engineered to be robust and reliable. It is suited for both routine measurement by non-specialists and, in the right configuration, for the most advanced research on the magnetic properties of materials.

Cooling for the system is now available in either re-condensing or liquid helium based environments. The recondensing system gives great advantages to the user in terms of reduced running costs and ease of operation.

Great care has been taken to make the S700X as user-friendly as possible. The new LabVIEW® software operates in an open environment that allows the user direct control of all parts of the system with real-time graphical displays of all the relevant functions.

The transparent nature of the operating system greatly improves the user's understanding of the experimental set-up, as well as providing unparalleled control for the most demanding measurements.

The Superconducting Quantum Interference Device (SQUID) Magnetometer

The SQUID is the most sensitive detector of magnetic signals available, with an input noise power sensitivity of about 10^{-30} Joules per root Hz. This value of energy sensitivity is 10^8 better than any semiconductor device, such as a FET, and accounts for the instrument's greater sensitivity and its ability to resolve small magnetic signals quickly.

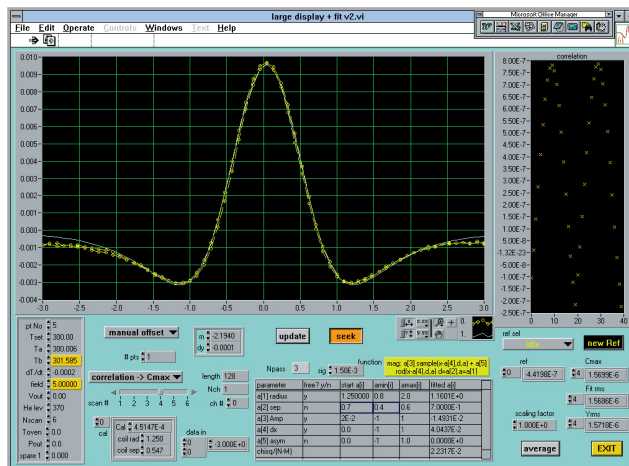

The characteristic signal of a sample.

The S700X has several modes of operation. The most widely used is the measurement of total magnetic moment made by moving the sample through the pick-up coils. This method is known as the extraction method.

Superconducting Extraction Magnetometry

To measure the magnetic moment of a sample in a DC magnetic field an extraction technique is used. The sample is moved vertically through a pickup coil which detects the flux via the current induced. In conventional extraction methods the signal is proportional to the rate of change of flux which means the faster you move the sample the bigger the signal. This can cause problems however because to get highly reproducible scans it is better to move the sample slowly. The S700X uses a superconducting pickup coil which means the signal is proportional to the flux and not to the rate of change, so the sample can be moved slowly and smoothly giving much greater reproducibility. The sample is moved up and then down through the pickup coil and the supercurrent, which is induced in the superconducting pickup coil to screen out the flux from the sample, couples the flux to the SQUID device.

The magnet which applies field to the sample is compensated to ensure the sample remains in a constant field throughout the movement. The compensated region is 20mm from the centre of the pickup coil.

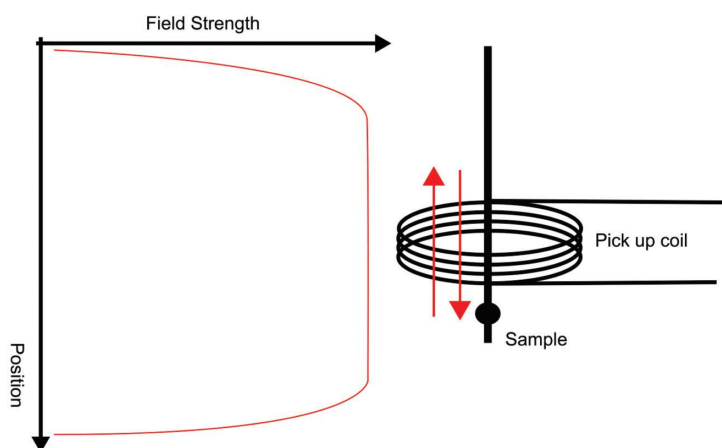

SQUID Magnet System with Integrated VTI

The superconducting magnet is produced using our proven technology for high field superconducting magnets. These magnets are manufactured using copper stabilised filamentary superconductor which is then vacuum impregnated with epoxy resin to form a composite structure of excellent mechanical strength and electrical insulation. The pick-up coil set is attached as part of the magnet structure.

A built-in magnetic shield made of mu-metal reduces the earth's field providing a sample environment of typically 10 milligauss. The combination of these two features with the low current option allows accurate measurements in the range of 10 milligauss to 150 gauss.

The system also has a full magnetic shield built into the cryostat to protect the measurement system from external influence and provide a background field of typically 100 micro-tesla at the sample measurement point

Sample Environment

A series of measurements at different temperatures and magnetic fields can be plotted and analysed to evaluate the sample. Time dependant measurement can also be made.

Samples are loaded into a transparent air lock. Once checked to see if it is correctly positioned the airlock is evacuated, purged and the sample can then be lowered 1 metre into the measure position.

Measurements are made by moving the sample through a second order pick-up coil set. The normal movement is 30-40mm to keep the sample in constant background field. The pick-up signal is detected by the SQUID as the sample moves in both directions. The characteristic curve is analysed and the moment calculated. Each measurement takes 5 seconds. The standard sample holder is non-magnetic and long enough that its movement does not create a background signal.

The sample space temperature is controlled using a multi-channel Lakeshore temperature controller. Liquid helium is drawn from the cryostat reservoir and expanded through a motor controlled needle valve. The gas at a base temperature of 1.5K is then passed through a heat exchanger which sets the temperature of the gas passing the sample. Two accurate thermometers are used, one at the heat exchanger and the second to monitor the sample space temperature just after the gas passed the sample. This ensures that the operator knows the sample temperature and its accuracy. This makes the S700 the most precise instrument available.

Linear Motor Option (SQUID-LM)

Experience has shown that the best measurements are made by using a repeated rapid sample movement over 20 mm pick up coil set. This gives the advantages of increased speed and higher precision with the full analysis power of the system using the standard 2nd order pick-up coil.

A miniature linear motor is used to move the sample. It has a total travel of 40 mm. Typically, measurements are made with a 25mm total movement at 1 - 3 Hz. The sample is mounted on a carbon fibre rod of 2mm diameter which is enclosed in a 5mm guide tube. The whole assembly is top loaded into the system and cooled by the gas in the VTI.

The signal from the moving sample is detected and measured by the SQUID connected to the pickup coil. The sample displacement is also measured to allow a phase and position lock of the detected signal. The sample can be positioned and moved over the full 150mm range with the stepper motor driven sample platform. This head is the same as in the S700X SQUID Systems and long movement measurements can be made as in the normal detection mode.

Standard SQUID measurements are also possible, these made by moving the sample through a second order pick-up coil set. The normal movement is 30-40mm to keep the sample in constant background field. The pick-up signal is detected by the SQUID as the sample moves in both directions. The characteristic curve is analysed and the moment calculated. Each measurement takes 5 seconds. The standard sample holder is non-magnetic and long enough that its movement does not create a background signal.

The ability to do both types of measurement in the same instrument increases its flexibility.



Key Advantages of the Cryogenic SQUID Magnetometer

- Ultra light design of the sample chamber allowing fast temperature changes and quick stability.
- Any temperature within the wide range of 1.6 K to 400 K can be held continuously, assuming liquid helium remains in the main reservoir
- AC susceptibility can be cross calibrated with DC magnetic moment.
- Sample exchange via airlock and cooling to 2 K possible in 10 to 15 minutes
- Change of measurement options / probes in 10 to 15 minutes.
- Faster measurement than any other commercial Susceptometer (makes more measurements per scan and reads in both directions).
- Full access to the operational functions.
- Upgradeable to allow further measurement options at a later stage.
- Automated measurement sequences allowing unattended operation.
- High quality electronics from well-established producers, such as the Lakeshore Temperature controller, allowing high reliability and replacement or recalibration of measurement electronics, as well as independent warranty and support.
- Full environmental shielding (both magnetic and electromagnetic).
- Remote control and support via the internet

The Liquid Helium SQUID Magnetometer

The main cryogenic element of the S700X consists of a variable temperature sample space insert upon which is mounted the superconducting magnet with the SQUID and magnetic detection coils.

At the top of the insert there is the sample movement system, an airlock to facilitate changing the sample and all the electrical feed-throughs for the magnetometer. The sample is mounted on a long rod with low magnetic moment which passes through a helium tight sliding seal into the sample space. Vertical translation and rotation of the sample are performed by stepper motors.

Temperature control of the sample is achieved by drawing a stream of helium gas past the sample. Liquid helium is drawn from the main helium reservoir in the cryostat and after expansion through an impedance, the gas passes through a heat exchanger which allows continuous variation of its temperature over the range of 1.6 K to 400 K. Control of the gas and sample temperature is achieved by an advanced electronic controller which measures the temperature of the gas stream to a resolution of 1 mK over the full range.

The sample space is sealed at the top with a gate valve and airlock so that samples can be changed while the system is cold without contamination of the cold space. The airlock is made of clear transparent plastic, so that the condition and position of the sample can be checked during the loading procedure just prior to lowering the sample to the measurement position.

The major components of the system are machined from solid stainless steel, which gives the S700X its excellent immunity to vibration and RF interference. The cryostat has a liquid nitrogen cooled radiation shield to provide a very low liquid helium consumption.



S700X-R Recondensing SQUID

The cryostat is cooled by an ultra-quiet pulse tube cooler which provides 1 Watt cooling power at 4 K and has a special built in facility for liquefying helium gas from room temperature.

The pulse tube cooler provides refrigeration at 4K for the liquid helium bath and at 50K for a radiation shield to intercept external radiation. The maintenance interval is 30,000 hours or 41 months of continuous operation. The cost of maintenance is also very reasonable. It involves changing a filter in the compressor and sometimes the exchange of the remote valve motor. It can all be done in a few hours without warming the system.

Tests have shown that there is no effect on the measurement performance of the SQUID Magnetometer from the operation of the pulse tube cooler, so it can run even when making the most sensitive measurements.

During start up the cryocooler will cool the system and then add a few litres of liquid per day to its internal reservoir. From room temperature the unit becomes operable after about 5 days. For a faster start up liquid helium can be filled from an external dewar into the system so as to become operational after about 48 hours.

In the event mains power is lost then the system will stay cold for more than 3 days. If power cuts are frequent then a back-up or stand-by generator that comes on within 1 to 10 minutes is preferred. The computer electronics rack is kept operational by a UPS electrical supply which gives 30 minutes autonomy, enough time to allow the stand by generator to restore power.

The zero boil-off Magnetometer system reduces long term operating costs very substantially and makes the operation and use of a SQUID Magnetometer practical in all locations, especially those areas where helium is expensive and regular supplies are difficult to acquire.



- Cooling via ultra quiet 1 Watt Pulse Tube Cryocooler
- 50 litre liquid helium reservoir
- Cryocooler liquefies the Helium gas from a cylinder at the rate of 2 litres per day
- Full magnetic shield built into the cryostat to protect the system from external influence
- Short- term fluctuation in heat load such as magnet ramping will not result in liquid helium loss as the system is supplied with a buffer tank of reserve helium gas
- Start-up and cooldown from Helium gas in just a few days
- Long service intervals: The pulse tube cooler has long service intervals with low servicing costs.
- Low operating costs: No liquid helium or nitrogen required for cool down or operation; there are no costs associated with storage, transport of liquids. Safety issues and training for personnel are minimised.

S700X-L with HE-3 Insert



The Electronics and Control System

A single rack contains all the electronics, including the Intel based computer, the pump and valves for controlling the flow of helium gas.

By incorporating all control systems into a single rack it is possible to fully integrate the design and eliminate ground loops which could disturb the system performance.

The major electronic components are all standard equipment, making service and support easier. They include the Lakeshore temperature controller, magnet power source, and the SQUID electronics. The data acquisition and control is provided by National Instrument cards which are LabVIEW® compatible. Special signal conditioning and isolating circuits are used to interface between the digital cards and the more sensitive elements of the instrument.

To supplement computer control of the system the main electronic instruments have front panel indicators and controls. These allow the operator to make independent confirmation of their correct function.

Environmental Shielding

The cryostat is fully shielded against the earth's background field and against locally generated magnetic and RF signals. An outer magnetic shield of mumetal reduces the background field in the sample space to about 0.5mG. Inside the cryostat a shield of superconducting material is used to further isolate the experimental space from external sources of magnetic interference.

The shielding factor from DC to a few kHz is 10^6 , more than sufficient to protect the measurements in all normal laboratory environments. The internal superconducting shield is placed outside the superconducting magnet so that the field does not disturb the shield, a great improvement over most other machines. The S700X has the dual advantage of the stability of a superconducting shield and the ability to make rapid measurements as a function of field.

The LabVIEW® Software control/automation

The software is written to operate under the National Instruments LabVIEW® operating environment. It is kept open and fully flexible allowing customer modifications and the establishment of new or different routines for measurement and analysis.

The provided software gives a full and completely automated control and measurement & analysis system for the characterisation of material magnetic properties as a function of field, orientation, temperature and time.

This software allows:

- Control of magnetic field
- Control of individual instruments (magnet power supply, temperature controller, gas handling system, etc.)
- Combine functions into measurement sequences.
- Fail-safe shutdown even with power failure.
- Customisation of measurement sequences as the software is fully "open-source"
- Real-time result display of results and system functionality
- Very short sample scan facility

To enhance the performance, the operating procedures are fully configurable. For example, when changes in temperature are required it is possible to set broad limits of stability for fast measurements or fine limits where precise and accurate measurements are required.

Measurement Options Measurement Results & Specifications

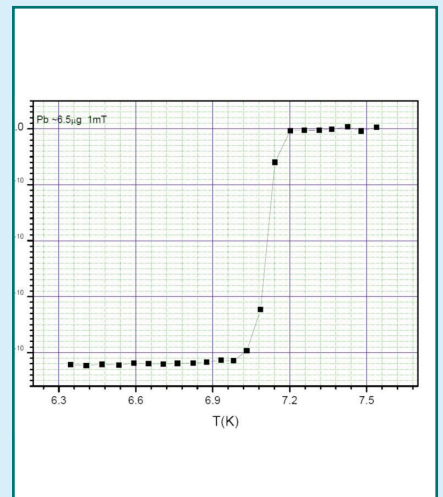

Extended Temperature Range

For some material science applications it is useful to measure magnetic properties from very low temperature to above room temperature. An oven insert is offered which increases the standard temperature range. In normal operation, the standard system has a continuous temperature range of 1.6 K to 400 K. For higher temperature, an oven must be used. The oven insert provides a temperature range of 200 K to 700 K.

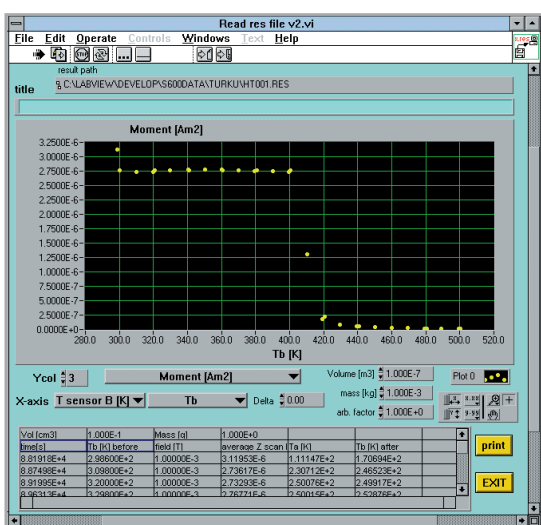

Magnetic moment of a ferrite as a function of temperature.

High pressure cell

The use of high-pressure generating technology as a means of physical-properties evaluation has developed considerably recently. The piston and cylinder method for generating high pressure on samples is often used for physical-properties research. A special cylinder is needed to apply high pressure on a sample when using the SQUID Magnetometer so as to reduce the magnetic background signal from the cylinder.



This high pressure experimental apparatus is now offered as a complete integrated system with special signal enhancement and subtraction software.

Resistivity Probe

We offer a small sample platform for basic four terminal resistivity or simply Hall measurement suitable to accommodate either one or two samples in parallel.

For each sample maximal 6 wires can be used to supply current and pick up voltage drops across the specimen. The probe consist of a glass fibre rod, which has on the top either a 6-pin or 12-pin Fischer connector as an interface to user electronics and an aluminium platform with solder pins to connect to the sample. A prepared software interface can integrate measurement software (provided by the user) in the automatic sequence control of the magnetometer. There are various LabVIEW® drivers available for different measurement devices (e.g. Keithley 2700, Lakeshore 370). Advice can be offered to adapt those to customer requirements. This probe cannot be used at the same time with the 3He-insert or high temperature probe.

Helium-3 Insert for temperatures down to 300 mK

The Cryogenic Helium-3 probe is designed as an alternative to the standard sample probe. The probe can extend the range of experimental temperatures accessible in the variable temperature sample space beyond the standard 1.6 K-400 K and can be used in either liquid helium cooled or cryogen-free systems. Using only the cooling power of the VTI and two internal temperature-controlled sorption pumps, the sample can be maintained at any temperature from below 300 mK to above 300 K.

The miniaturised Helium-3 pot fits inside the 9 mm susceptometer VTI and a high-purity silver cold finger is used to position the sample in the magnet bore. A working volume of 0.9 cc of Helium-3 is sufficient to maintain temperatures down to 300 mK for up to 12 hours.

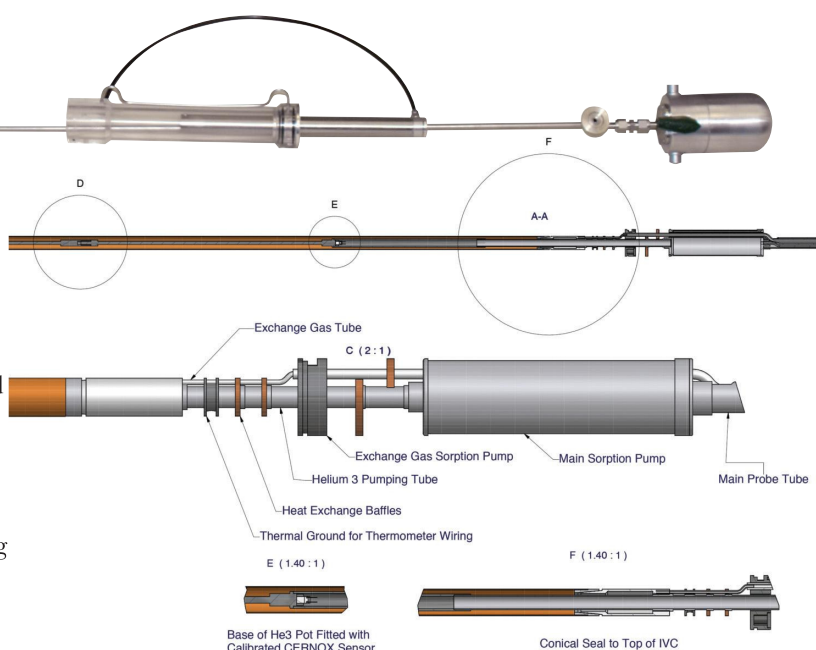

AC Susceptibility Option

An AC measurement option is available as a complement to the standard DC method to study the magnetic susceptibility of materials directly. We offer the facility to perform direct susceptibility measurements in AC magnetic fields from 10^{-2} to 500 Hz. The magnet is fitted with a separate coil for the AC field, providing up to 5 Gauss and driven by the main system electronics.

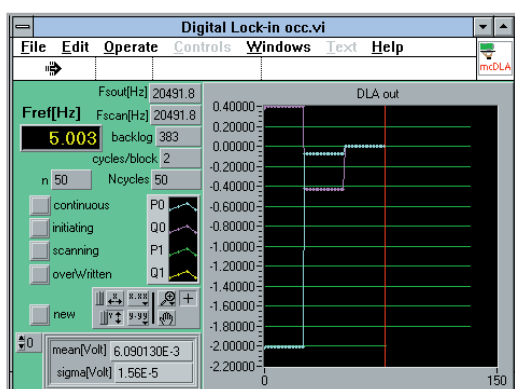

The AC option window.

To make accurate measurements of the complex AC susceptibility of the sample, it is important to eliminate the instrument response time. The S700X software performs this function by moving the sample between the pick-up coils, making two measurements so that instrument errors are removed from the results. This feature increases the sensitivity and accuracy of both the in-phase and out-of-phase response. It represents another example of the flexibility and sophistication of the S700X software.

Ultra Low Field Options

Many measurements are required in fields as close to zero field as practical. Since all superconducting magnets exhibit remanence, a small magnetic field will be left after an excursion to high field even when there is no current in the magnet. Use of a special degaussing program allows the remanent field to be reduced from its typical normal value of about 0.7 mT down to less than 0.1 mT. If the magnet has previously been to high field then the remanent magnetism can be removed either by heating the magnet or by going through a degaussing procedure.

For controlled measurements at the lowest fields it is convenient to apply a magnetic field with higher resolution. By adding a precision 4-quadrant low current source (500 mA) to the main power supply, very low fields in the region ± 50 mT (500 G) can be obtained with a high degree of certainty and avoiding a significant remanent field in the magnet.

The low field option covers the range of ± 50 mT. It allows the user to set the field in this range with the precision of 1 micro Tesla ($=0.01$ G). True Zero field (± 0.001 G), assuming the system is shielded from the earth's field, can be achieved by warming the magnet above the critical temperature and subsequent cool-down. Zero field to within 1 Gauss can be achieved using the degauss procedure.

Transverse Moment Facility with Sample Rotation

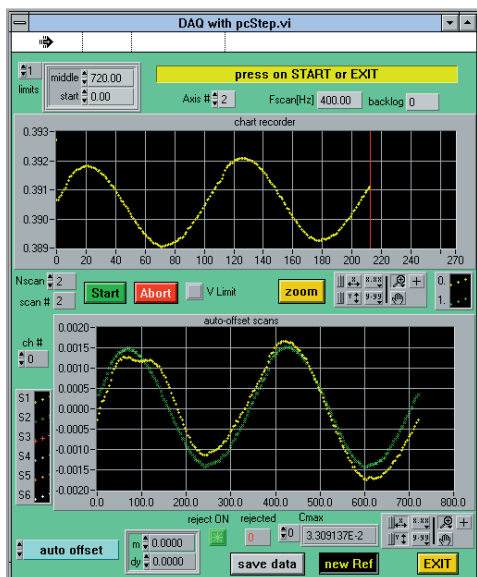

Transverse moment window.

Some crystal structures exhibit anisotropic magnetic characteristics. To allow these to be measured the S700X can be fitted with a signal detection circuit, sensitive only to a magnetic moment perpendicular to the vertical applied magnetic field. This transverse moment is amplified by a second SQUID circuit. The output is recorded as the sample is rotated around the vertical axis by a computer controlled stepper motor. In this way the anisotropic moment may be measured and studied.

Dynamic Range Extender

The S700X is an exceptionally sensitive instrument with the result that strongly magnetised materials can only be studied if prepared in minute samples. For greater convenience Cryogenic offers a dynamic range extender which reduces the input signal by a factor of 500, allowing strongly magnetised materials to be measured conveniently in the same instrument as those of very low magnetic moment. With this option the standard measurement range (10^6 total dynamic range) from 10^{-11} to 10^{-5} Am² can be extended to measure signals as large as 5×10^{-3} Am² (5 emu).

Fluxgate Field Measurement System

The fluxgate measures and profiles fields up to 20 G with a resolution of 10^{-5} G. For some applications it is very important to verify the magnet field at very low applied fields. Additionally, the fluxgate can also profile the magnet along its entire length. This facility is recommended with the ultra low field option.

Hall Probe Field Measurement Facility

The Hall probe is offered to enable the magnetic field to be measured at higher fields. It allows fields from 0.1 G to 10^5 G to be profiled and measured, complimenting the fluxgate. For high accuracy, the zero offset must be referenced.

Special Measurement Options:

Cryogenic prides itself in being able to keep its clients at the forefront of research using the most advanced technology. As such we are always prepared to consider supplying other special options. Transverse magnetic field coils, optical and microwave illumination of the sample are some examples of the special options that can be provided. Further requests are always welcome.

Measurement Results

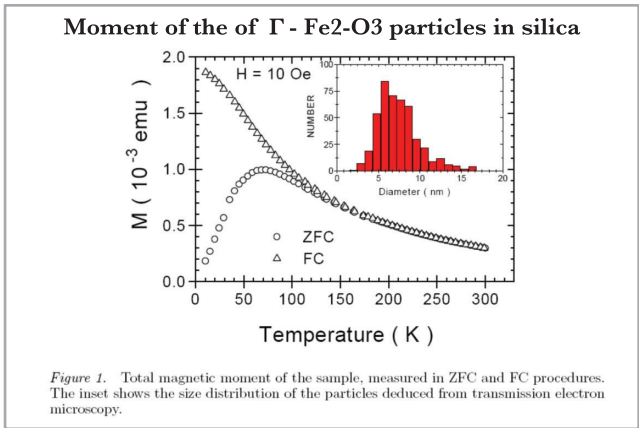
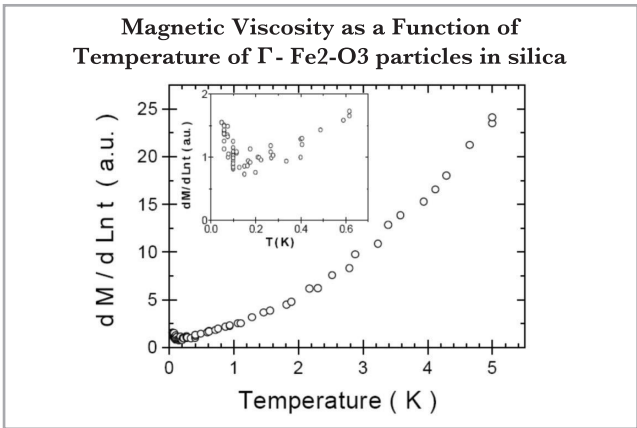
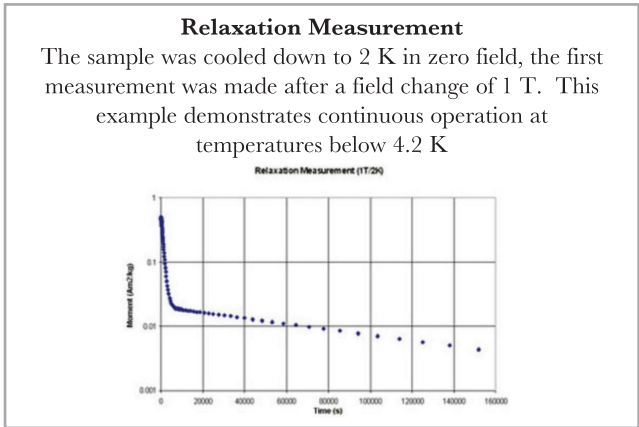
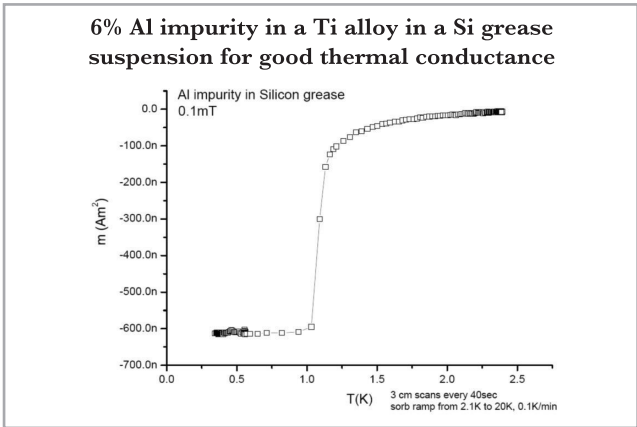
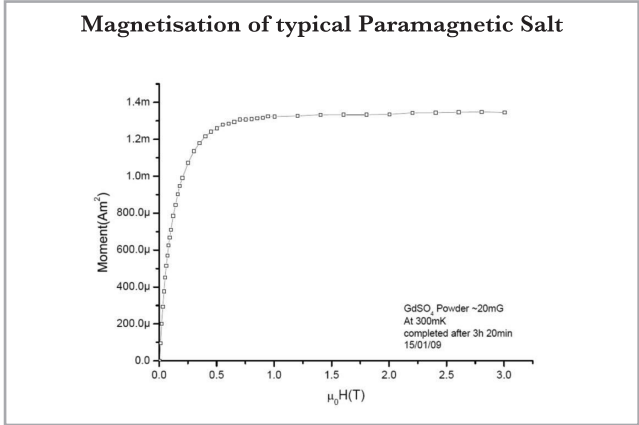
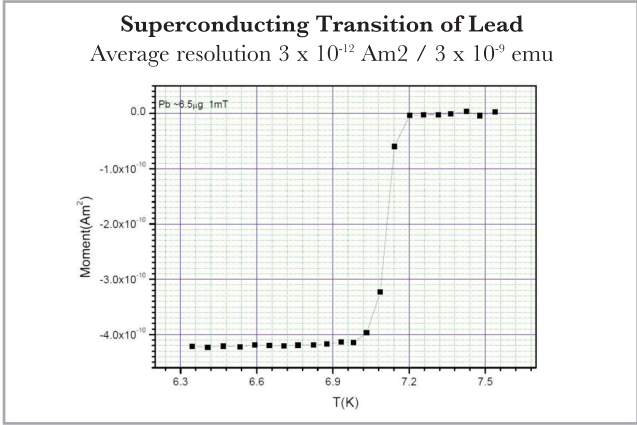
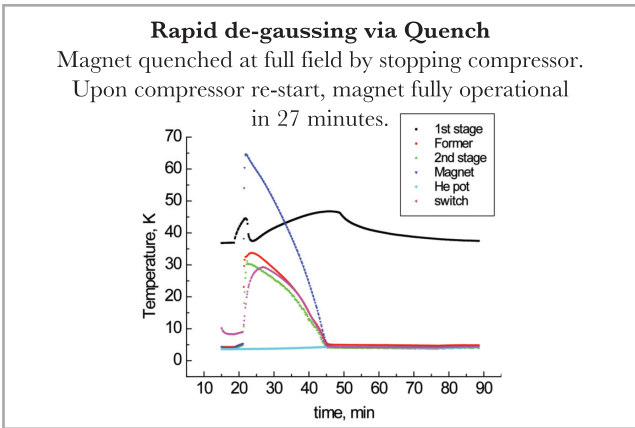
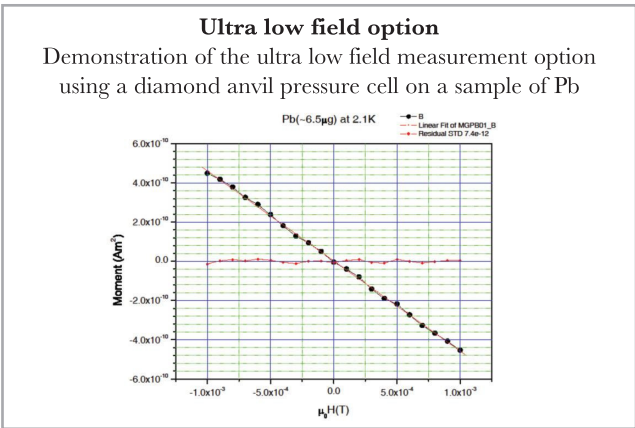
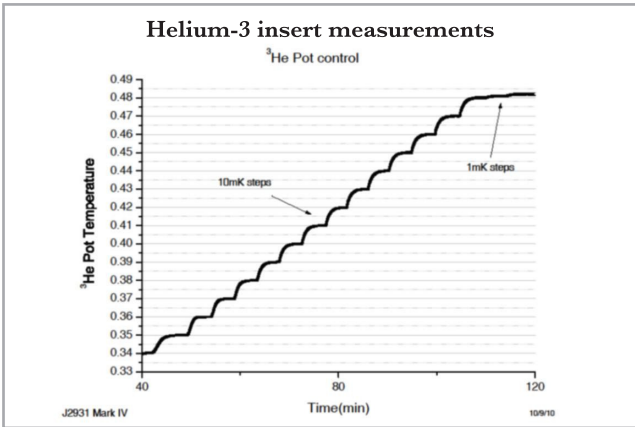
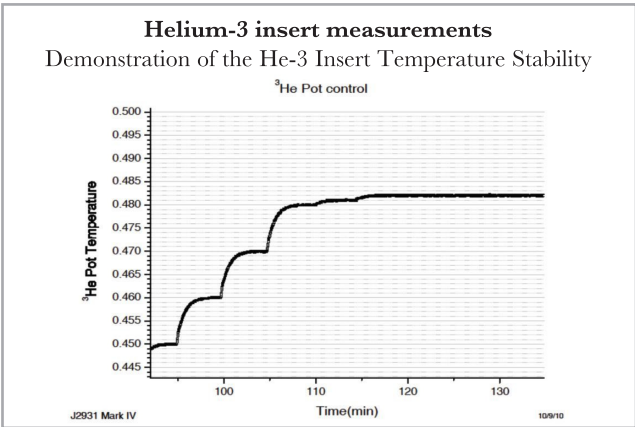
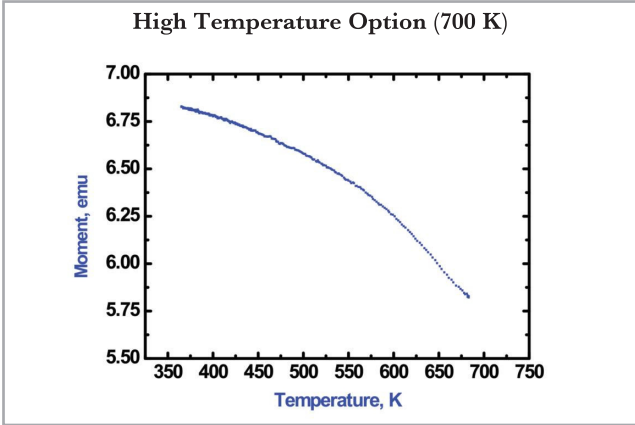
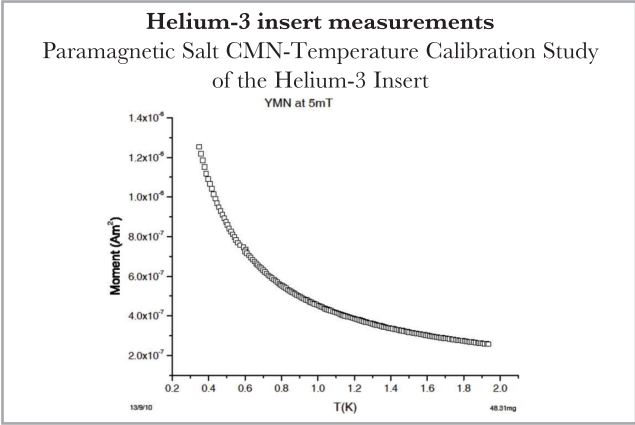

Figure 1. Total magnetic moment of the sample, measured in ZFC and FC procedures. The inset shows the size distribution of the particles deduced from transmission electron microscopy.

Measurement Results



Specifications

DESCRIPTION	
Field range:	±7 Tesla
Field stability: Long term:	0.1ppm/hr
Central field uniformity over ±2cm:	0.01%
Field set resolution (20 bit) Standard range: Low field option:	0.007 mT 10 ⁻⁷ T
Maximum Remenant field:	~ 0.7 mT (7 Gauss)
Maximum current:	80 Amps
Maximum sample size:	< 9 mm
DC magnetisation (1,2 and 3 axes) Differential sensitivity:	1x10 ⁻⁸ EMU 5-10 ⁻⁷ in 7 T
Range of measurement Standard Extended	10 ⁻⁸ to 10 ⁻² EMU 10 ⁻⁸ to 5 EMU
AC Susceptibility (1,2 and 3 axes):	0.01 Hz to 500 Hz
Frequency range: Sensitivity:	1x10 ⁻⁸ EMU in 1 T 3x10 ⁻⁷ EMU in 7 T
Temperature Range Standard Extended	1.6 K to 400 K 0.3 K to 700 K
Temperature calibration Number of sensors Accuracy of calibration	2 0.3%
Temperature stability At sample At sample At sample	2 mK @ 10 K 3 mK @ 100 K 10 mK @ 300 K
Temperature resolution	1 mK all temperatures
Temperature spatial variation in sample region: At 20K At 100K At 100K	±5 K over 4 cm long ±25 mK over 4 cm long ±80 mK over 12 cm long
Rate of temperature change (inc. stabilisation): ±5K ±100K ±295K	5 mins 20 mins 30 mins



Unit 30 Acton Park Industrial Estate, The Vale, London W3 7QE, United Kingdom
Tel: +44 (0)20 8743 6049 Fax: +44 (0)20 8749 5315 Email: sales@cryogenic.co.uk www.cryogenic.co.uk