

# Shamrock 163

## Versatile, Compact Benchtop Spectrograph

### Key Specifications

- ✓ 163 mm focal length
- ✓ F/3.6 aperture
- ✓ Compact form factor
- ✓ Field adjustable gratings and light coupling accessories

### Key Applications

- ✓ Raman
- ✓ Absorption/Transmission/Reflection
- ✓ Fluorescence/Luminescence/Photoluminescence
- ✓ Non-linear spectroscopies (SFG, SHG)



# Introducing Shamrock 163

The Shamrock 163 is the most compact research-grade Czerny-Turner spectograph on the market. Its 163 mm focal length, high F/3.6 aperture and wide range of seamlessly interchangeable gratings, slits and light coupling accessories make it the ideal tool for general benchtop spectroscopy measurements.



## Specifications Summary

Resolution with Newton DU940 CCD 1200 l/mm @ 500 nm 2400 l/mm @ 300 nm	0.25 nm 0.12 nm
Aperture	F/3.6
Focal length	163 mm
Grating	Single, interchangeable
Slit widths range (input/output)	Fixed: 10, 25, 50, 100, 200 $\mu$ m Adjustable (manual): 10 $\mu$ m to 3 mm
Slit height options	3 mm (6 mm on request)
Size (L x W x H)	198 x 216 x 96 mm 7.8 x 8.5 x 3.8 in
Weight	3.5 kg (7.71 lb)

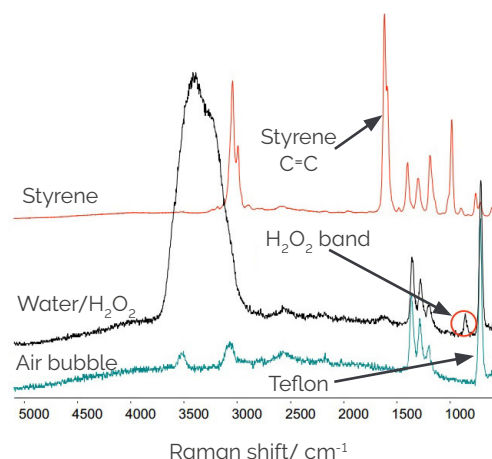

Above: Biphasic reaction monitoring of oxidation of styrene with a dinuclear manganese catalyst.  
Courtesy of Wesley Browne & David Angelone,  
University of Groningen

## Features and Benefits

Feature	Benefit
Portability & ease of integration	Compact & rugged design with horizontal and vertical mounting positions
Imaging-configurable platform for multi-track spectroscopy	Lens-based accessories enable optimization of system performance for low cross-talk, multi-leg fibre signal simultaneous acquisition
Wide range of interchangeable gratings	Simple precision locking mechanism for rapid upgradability to different resolution, blaze and bandpass options
Variety of fixed slits	Interchangeable laser-cut precision slits with widths ranging from 10 $\mu$ m to 200 $\mu$ m
Large choice of light coupling interfaces	Free space or using fibre-optic couplers
Simple & rapid wavelength adjustment	Calibrated micrometer drive for wavelength selection

# Step-by-Step System Configuration

How to customise the Shamrock 163:

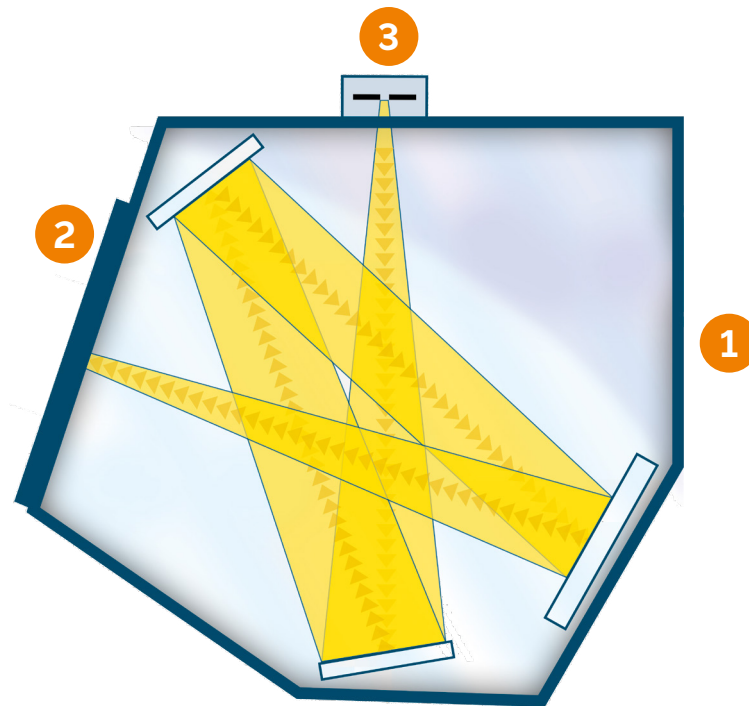

## 1 Chassis configuration

Select type of optics coating required (aluminium +  $\text{MgF}_2$  is standard, protected silver-coated optics available on request for NIR detection).

## 2 Resolution & band-pass

Select gratings and detector to fulfil resolution and wavelength requirements.

## 3 Input light coupling interface

Refer to accessory tree for available configurations (direct coupling, fibre coupling or 3<sup>rd</sup> party hardware connectivity).

## 4 Software interface

Select either state-of-the-art Solis software or Software Development Kit (SDK) option – please refer to the appropriate section for further information.

# Step 1 - Chassis Configuration

## Ordering Information

Description	Model
Base unit for spectrally optimized configuration	SR-163
Base unit for spectrally optimized configuration, protected silver coated optics	SR-163-SIL

## Optics Coatings Reflectivity Graph

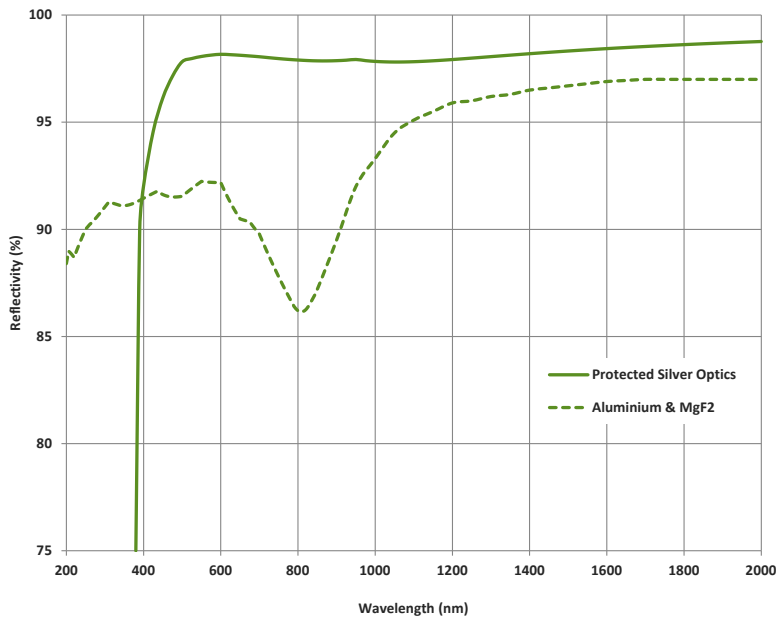

The graph shows the standard Al + MgF<sub>2</sub> optics coatings reflection efficiency versus wavelengths.

Protected silver coated optics option is also available on request for maximum efficiency in the NIR region and is recommended for working with Andor iDus InGaAs detectors.

When choosing protected silver coatings, it is strongly recommended to also order **protected silver coated gratings** for maximum efficiency throughout the system.

## Chassis Accessories

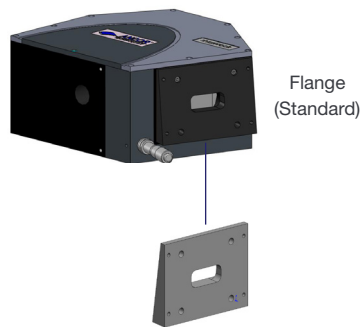

Flange (Standard)

InGaAs Flange (SR1-ASZ-8044)

NOTE: Not to be used in conjunction with imaging corrected (multi-track enabling) input accessories

## Step 2a - Choosing The Right Platform vs Dispersion Requirements

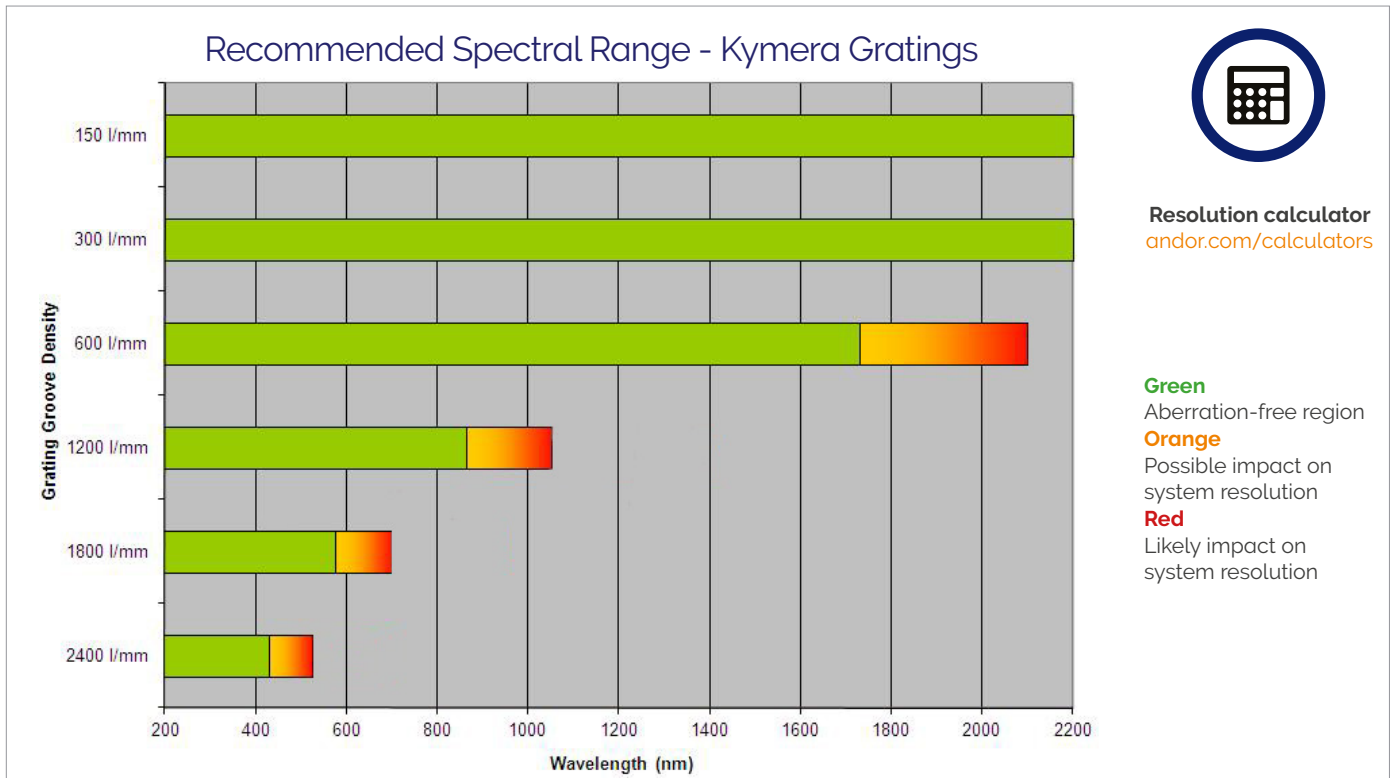

Czerny-Turner spectrographs are designed to provide the best optical performance for a range of grating angles as reflected on the green parts of the graph above. Outside this range, the spectral lines may exhibit a degree of optical aberration (such as coma), which will become more prominent at the steeper angles. These configurations are reflected by the orange to red scales on the graph. In these regions, consideration should be given to higher spectrograph focal length models with lower groove density gratings to achieve the desired resolution.

	Grating (l/mm)					
	150	300	600	1200	1800 (Holo)	2400 (Holo)
Shamrock 163						
Bandpass (nm) <sup>•3,•5</sup>	1072	529	256	117	68	56 <sup>•6</sup>
Resolution (nm) <sup>•4,•5</sup>	1.57	0.77	0.37	0.17	0.10	0.08 <sup>•6</sup>
Kymera 193i						
Bandpass (nm) <sup>•3,•5</sup>	902	445	215	98	56	46 <sup>•6</sup>
Resolution (nm) <sup>•4,•5</sup>	1.96	0.96	0.47	0.21	0.12	0.10 <sup>•6</sup>
Kymera 328i						
Bandpass (nm) <sup>•3,•5</sup>	542	268	131	61	41	29 <sup>•6</sup>
Resolution (nm) <sup>•4,•5</sup>	0.88→0.62	0.44→0.31	0.21→0.15	0.10→0.07	0.06→0.04	0.05→0.04 <sup>•6</sup>

Where aberration is a concern for a particular experimental set-up, the table above shows resolution and band-pass performance for a variety of alternative configurations. This should be used in conjunction with the graph above to assist in selecting the most appropriate spectrograph platform to meet resolution and band-pass needs, whilst minimising the risk of potential aberration.

## Step 2b - Choosing The Right Grating vs Resolution and Band-pass

The Shamrock 163 grating mount has been designed for easy integration and interchangeability. A simple finger-tight locking mechanism combined with a precision locating fixture ensure accurate and rapid system upgradability. Please select the grating or gratings you require from the selection in the table below.



Lines/mm	Blaze (nm)	Nominal dispersion (nm/mm) <sup>7</sup>	Bandpass (nm) <sup>3,7</sup>	Resolution (nm) <sup>4,7,10</sup>	Peak efficiency (%)	Andor part number	Maximum recommended wavelength (nm)
150	300	19.70	545	0.89→0.62	72	SR-GRT-0150-0300	6820
150	500	19.60	542	0.88→0.62	73	SR-GRT-0150-0500	
150	800	19.50	539	0.88→0.62	80	SR-GRT-0150-0800	
150	1250	19.30	534	0.87→0.61	84	SR-GRT-0150-1250	
150	2000	18.90	523	0.85→0.60	88	SR-GRT-0150-2000	
300	300	9.80	271	0.44→0.31	88	SR-GRT-0300-0300	3410
300	500	9.71	268	0.44→0.31	81	SR-GRT-0300-0500	
300	1000	9.46	262	0.43→0.30	72	SR-GRT-0300-1000	
300	1200	9.34	258	0.42→0.29	92	SR-GRT-0300-1200	
300	1700	9.00	249	0.41→0.29	89	SR-GRT-0300-1700	
600	300	4.83	134	0.22→0.15	84	SR-GRT-0600-0300	1705
600	500	4.73	131	0.21→0.15	72	SR-GRT-0600-0500	
600	1000	4.38	121	0.20→0.14	72	SR-GRT-0600-1000	
600	1200	4.20	116	0.19→0.13	88	SR-GRT-0600-1200	
600	1900 (@1600) <sup>8</sup>	3.39 3.78	94 105	0.15→0.11 <sup>9</sup> 0.17→0.12	88	SR-GRT-0600-1900	
830	820	3.08	85	0.14→0.10	87	SR-GRT-0830-0820	1230
830	1200	2.68	74	0.12→0.08	83	SR-GRT-0830-1200	
1200	300	2.33	64	0.10→0.07	72	SR-GRT-1200-0300	850
1200	500	2.19	61	0.10→0.07	81	SR-GRT-1200-0500	
1200	1000	1.62	45	0.07→0.05 <sup>9</sup>	69	SR-GRT-1200-1000	
1200	(@ 800) <sup>8</sup>	1.89	52	0.09→0.06	69		
1200	Holographic (500 nm peak)	2.19	61	0.10→0.07	81	SR-GRT-1200-EH <sup>†</sup>	
1800	Holographic (250 nm peak)	1.30	36	0.06→0.04	70	SR-GRT-1800-DH	570
1800	Holographic (380 nm peak)	1.52	42	0.07→0.05	62	SR-GRT-1800-FH	
2400	300	1.05	29	0.05→0.04	68	SR-GRT-2400-0300	425
2400	Holographic (220 nm peak)	1.12	31	0.05→0.04	68	SR-GRT-2400-BH	
2400	Holographic (400 nm peak)	0.95	26	0.04→0.03	73	SR-GRT-2400-GH	

<sup>†</sup>Option for minimized scattered light.

**Need to have maximum collection efficiency in the NIR/SWIR?** All gratings are also available with protected silver coating. Please contact your local representative for further information.

# Step 2c - Selecting The Correct Grating Efficiency Option

All graphs shown below represent efficiency for 45° polarisation

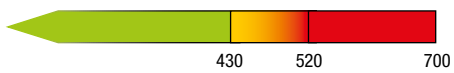
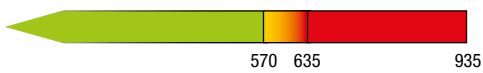
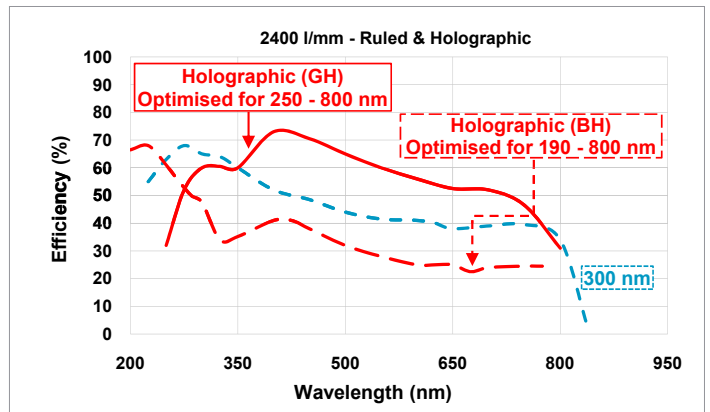
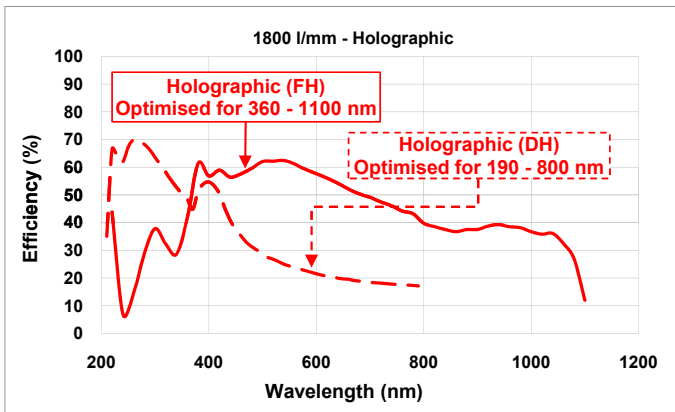
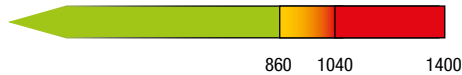
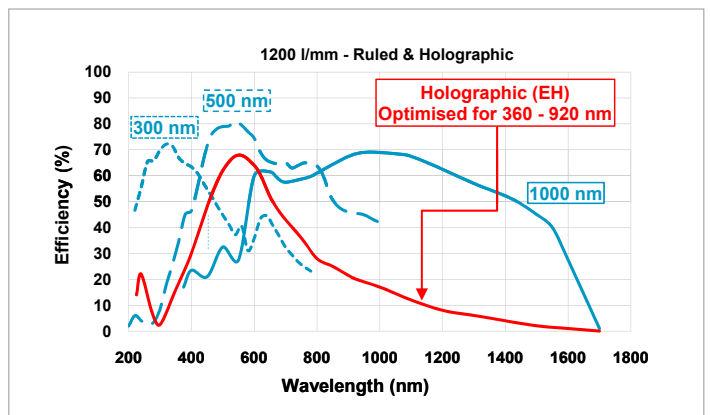
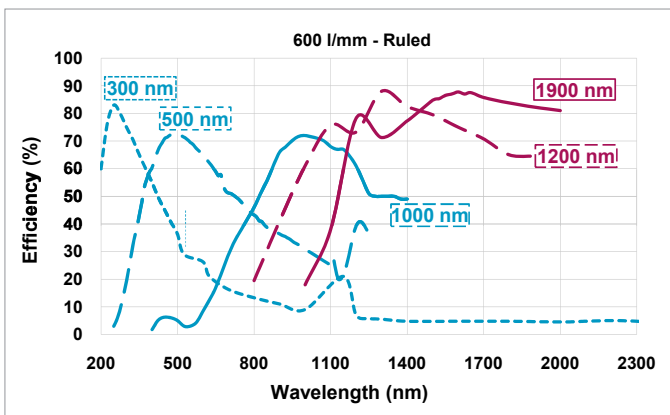
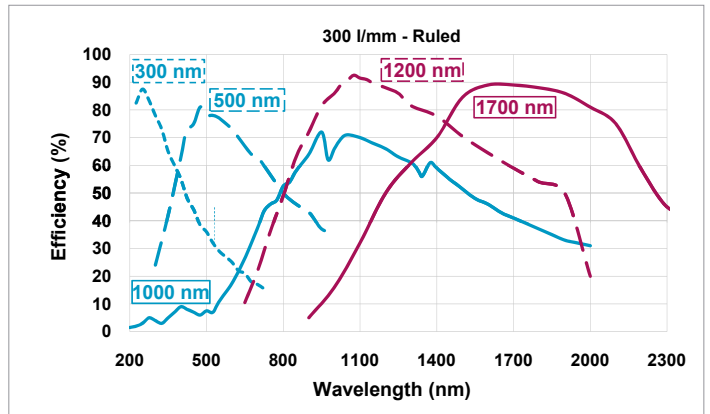
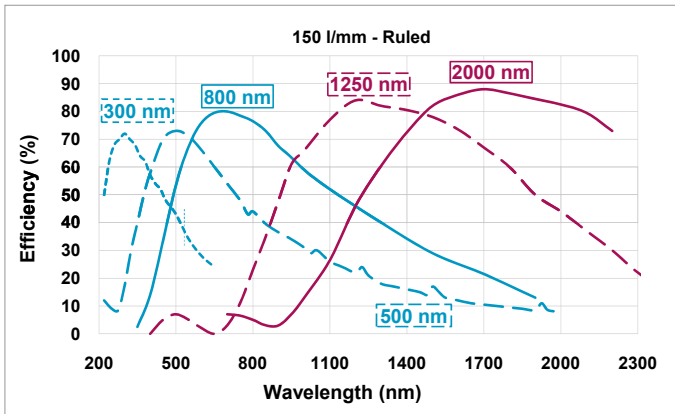

## Important Consideration

System throughput is dependent on the grating's angle of operation and may decrease with higher grating operating angles.

# Step 3 - Selecting The Correct Light Coupling Interfaces

Lens-corrected accessory for multi-track applications

Fixed Slit Dimensions

Standard Slit <sup>8</sup>	Shutter Slit <sup>8</sup>	Size
SR1-SLT-0010-3	SR1-SLH-0010-3	10 μm x 3 mm (W x H)
SR1-SLT-0025-3	SR1-SLH-0025-3	25 μm x 3 mm (W x H)
SR1-SLT-0050-3	SR1-SLH-0050-3	50 μm x 3 mm (W x H)
SR1-SLT-0100-3	SR1-SLH-0100-3	100 μm x 3 mm (W x H)
SR1-SLT-0200-3	SR1-SLH-0200-3	200 μm x 3 mm (W x H)

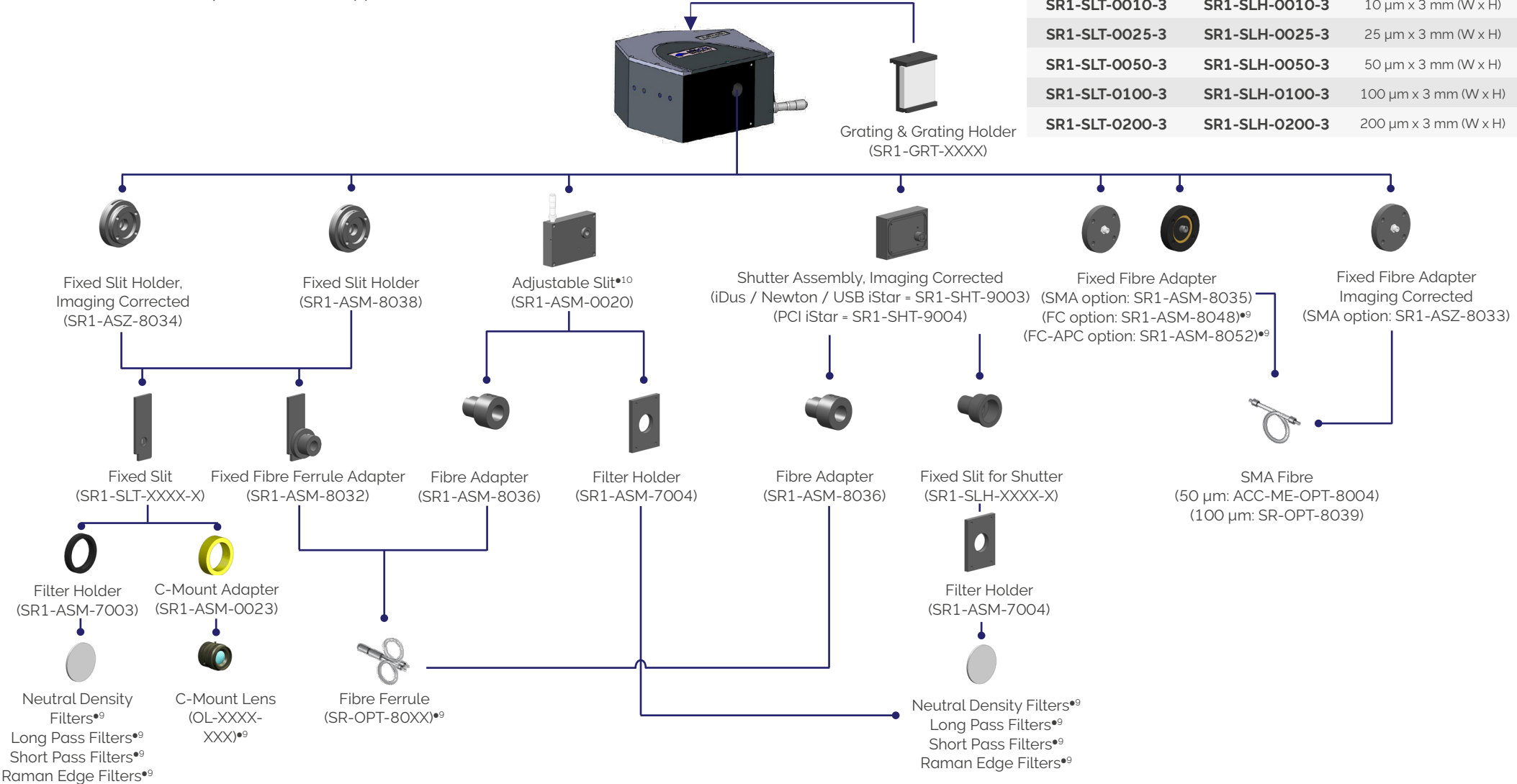



## Step 4 - Selecting A Software Option

The Shamrock 163 requires at least one of the following software options:

1 - **Solis Spectroscopy A** 32-bit and fully 64-bit enabled application for Windows (8, 8.1 and 10) offering rich functionality for data acquisition and processing, as well as Andor cameras, spectrograph and motorized accessories simultaneous control. AndorBasic provides macro language control of data acquisition, processing, display and export.

2 - **Standalone Solis Spectroscopy GUI** for standalone spectrograph operation.

3 - **Kymera and Shamrock SDK**: A software development kit that allows you to integrate Andor detectors and spectrographs in your own application. Compatible as 32-bit and 64-bit libraries for Windows (8, 8.1 and 10). Compatible with C/C++, C#, VB.NET and LabVIEW for Windows/Linux.

Note: Motorised accessories control panel only available for Kymera and Shamrock 500i/750 series.

## Solis Spectroscopy: Dedicated spectroscopy acquisition software

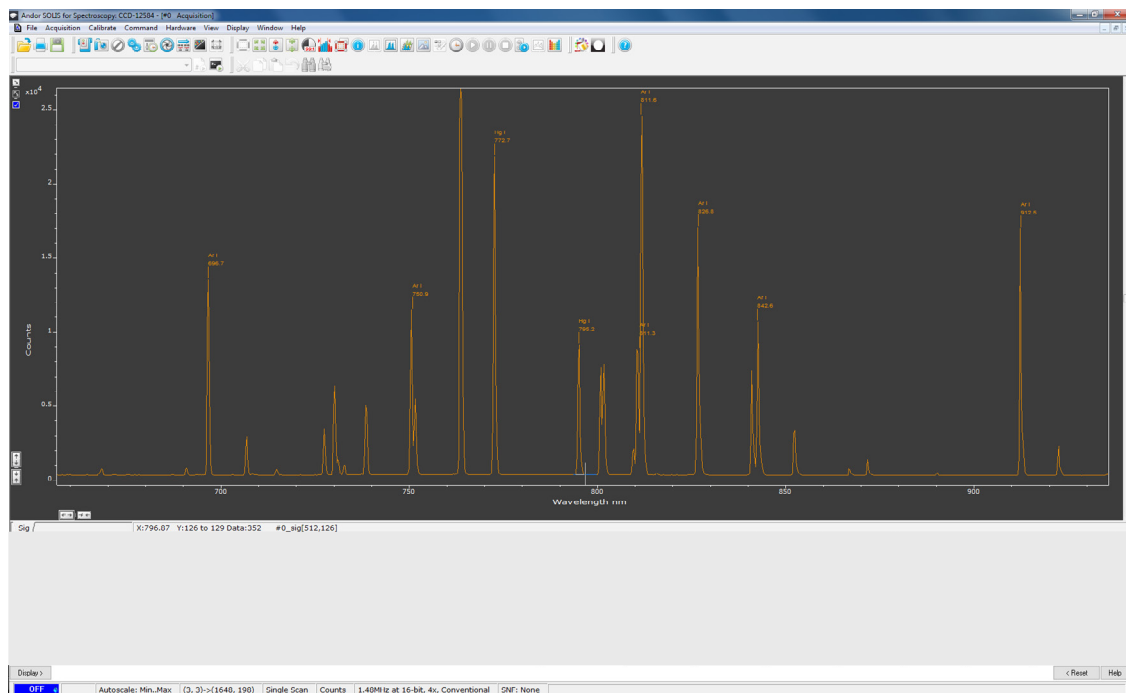

## Product Drawings

Dimensions in mm [inches]

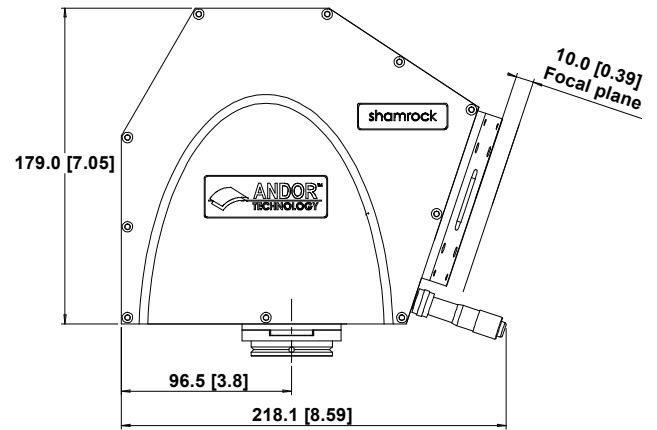
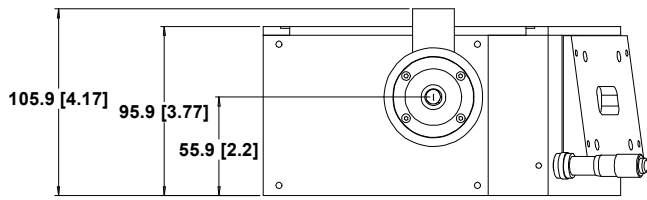

### Screw Type Requirements

Camera attachment to CCD flange 4 off, 6/32 x 3/8 UNC

## Typical Setup - Spectroscopy

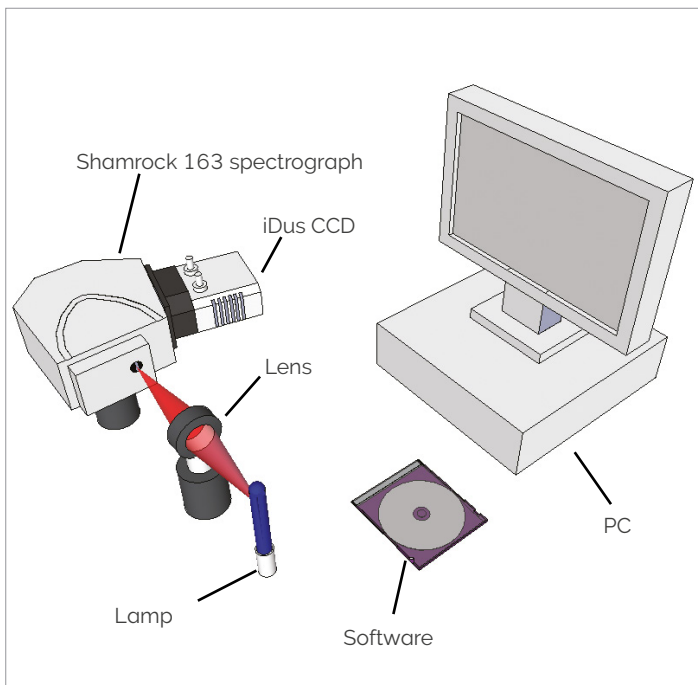

## Shutter Specifications

Maximum repetition rate	1 Hz
Minimum open/close time	100 ms

## Optical Property

Focal plane size (mm, W x H)	28 x 10
Magnification @ centre of CCD (independent of line elongation due to spectrograph astigmatism) <i>Vertical, multi-track configuration</i>	1.8

# Our Cameras for Spectroscopy

Spectroscopy-based diagnostics in the fields of Material Science, Chemistry, Life Science or Fundamental Physics & Optics rely on the capture and analysis of optical and chemical signatures with a high degree of precision.

Andor's range of detectors offer a wide range of sensitivity, time-resolution and sensor formats to best suit specific experimental conditions from UV to SWIR, nanosecond to hours time resolution, high photon flux to single photon with super dynamic range and resolution.

## High Sensitivity & Dynamic Range



- ✓ Long exposure
- ✓ High sensitivity UV-SWIR
- ✓ Large pixel well depths
- ✓ High resolution matrix

iDus CCD & InGaAs | Newton CCD & EM

## ns to $\mu$ s Time-Resolution



- ✓ Nanosecond gating
- ✓ High sensitivity down to single photon
- ✓ On-head DDG with ps accuracy

iStar CCD & sCMOS

## kHz Spectral Rates

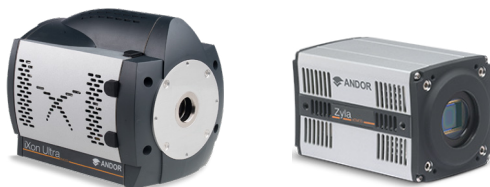

- ✓  $\mu$ s to ms time-resolution
- ✓ High sensitivity down to single photon
- ✓ High resolution matrix

Newton CCD & EMCCD | iXon EMCCD |  
Zyla sCMOS | Marana sCMOS

## Extended Multi-fibre Spectroscopy

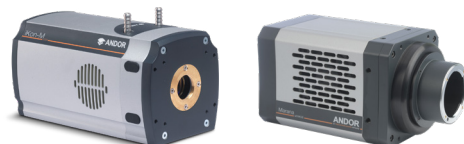

- ✓ Large area sensors
- ✓ Ultrafast sCMOS and EMCCD options
- ✓ High sensitivity down to single photon

iKon-M CCD | iXon EMCCD | Zyla sCMOS |  
Marana sCMOS | iStar CCD & sCMOS

Learn more about our detector range [here](#).



Learn more about our spectrograph solutions [here](#).

# Order Today

At Andor we are committed to finding the correct solution for you. With a dedicated team of technical advisors, we are able to offer you one-to-one guidance and technical support on all Andor products.

For a full listing of our local sales offices, please see: [andor.com/contact](http://andor.com/contact)

Our regional headquarters are:

## Europe

Belfast, Northern Ireland  
Phone +44 (28) 9023 7126  
Fax +44 (28) 9031 0792

## Japan

Tokyo  
Phone +81 (3) 6732 8968  
Fax +81 (3) 6732 8939

## North America

Concord, MA, USA  
Phone +1 (860) 290 9211  
Fax +1 (860) 290 9566

## China

Beijing  
Phone +86 (10) 5884 7900  
Fax +86 (10) 5884 7901

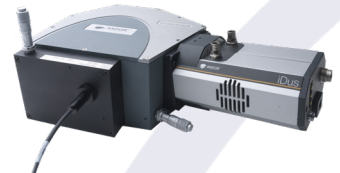

### Items shipped with your spectrograph

1x Electronic copy of user guides  
1x Individual system performance booklet  
1x Set of Allen keys (1.5 mm, 2 mm & 2.5 mm)

### Operating & Storage Conditions

- Operating Temperature 0°C to 30°C ambient
- Relative Humidity < 70% (non-condensing)
- Storage Temperature -25°C to 50°C

### Footnotes: Specifications are subject to change without notice

1. Typical values quoted with 27.6 mm wide CCD, e.g. Newton DU940.
2. Typical values quoted with 10  $\mu$ m slit and 13.5  $\mu$ m pixel CCD, e.g. Newton DU940. Useful signal is assumed to be imaged on the entire height of the 6.9 mm sensor and fully vertically binned.
3. Typical values quoted @ 500 nm centre wavelength.
4. Typical values quoted @ 300 nm centre wavelength.
5. Typical values quoted at maximum efficiency wavelength or blaze wavelength unless otherwise stated.
6. Wavelength within the recommended operating spectral region.
7. Indicative values; the working range of these gratings is principally in the region where optical aberrations may alter the system resolution performance quoted.
8. 6 mm high options available on request.
9. Please refer to the local sales representative or website for further information on available options and complimentary accessories.
10. Slit width ranges from 10  $\mu$ m to 2.5 mm.



$\mu$ Manager

