



USER'S GUIDE TO THE:



Classic PCI CCD

www.andor.com

© Andor Technology plc 2007

	<u>PAGE</u>
SECTION 1 - ABOUT ANDOR CLASSIC PCI CCD	14
1.1 - INTRODUCTION TO THE ANDOR CLASSIC CCD	14
1.2 - WORKING WITH THE USERS GUIDE	14
1.3 - HELP	14
1.4 - DISCLAIMER	15
1.5 - COPYRIGHT AND PROTECTIVE NOTICES	15
1.6 - TRADEMARKS AND PATENT INFORMATION	15
1.7 - TECHNICAL SUPPORT	16
1.7.1 - Europe	16
1.7.2 - USA	16
1.7.3 - Asia-Pacific	16
1.7.4 - China	16
1.8 - WORLDWIDE DISTRIBUTORS	17
1.9 - COMPONENTS	18
1.9.1 - Optional extras	18
1.9.2 - Detector Head	19
1.9.2.1 - Rear connector	20
1.9.2.2 - Detector Head to Controller Card Cable	20
1.9.2.3 - PCI Controller Card	21
1.9.2.4 - Auxiliary Cooling Connector	22
1.9.2.5 - IO160 Multiple Input/Output Box	22
1.9.2.5.1 - IO160 Connections & Pin-outs	23
1.9.2.6 - IO165 Advanced Multi I/O Box	24
1.9.2.6.1 - IO165 Connections & Pin-outs	24
1.9.3 - Optional Spectrograph	25
1.9.4 - Optional Mounting Flanges	25
1.9.5 - Software	25
1.10 - COOLING	26
1.10.1 - Air cooling performance	27
1.10.2 - Water cooling performance	28
1.10.3 - Cooling with External Power Supply Unit	29
1.10.4 - Cooling with Plug-In Card only	29
1.11 - SAFETY PRECAUTIONS	30
1.11.1 - Care of the Detector Head	30
1.11.2 - Working with electronics	30
1.11.3 - Condensation	31
1.11.4 - Head overheating	31

	<u>PAGE</u>
SECTION 2 - INSTALLATION	32
2.1 - INSTALLING THE HARDWARE	32
2.1.1 - Computer requirements	32
2.2 - INSTALLING THE CONTROLLER CARD	33
2.3 - CONNECTING THE SYSTEM	34
2.4 - INSTALLING THE SOFTWARE	35
2.4.1 - Windows 2000/XP	35

	<u>PAGE</u>
SECTION 3 - USING THE CCD	36
3.1 - STARTING THE APPLICATION	36
3.2 - MAIN WINDOW	37
3.3 - HOT KEYS	39

	<u>PAGE</u>
SECTION 4 - PRE-ACQUISITION	41
4.1 - SETTING TEMPERATURE	41
4.2 - SETUP ACQUISITION	43
4.2.1 - Acquisition & Readout Mode combinations	44
4.3 - AUTO-SAVE	46
4.4 - SPOOLING	47

	<u>PAGE</u>
SECTION 5 - ACQUIRING DATA	48
5.1 - INITIAL ACQUISITION	48
5.2 - DATA TYPE SELECTION	49
5.3 - ACQUISITION TYPES	53
5.3.1 - Take Signal with Autoscale Acquisition Off	54
5.3.2 - Take Signal with Autoscale Acquisition On	54
5.3.3 - Take Background	55
5.3.4 - Take Reference	55
5.3.4.1 - Acquisition Errors	55
5.4 - ORGANIZING WINDOWS	56
5.5 - ACQUISITION MODES & TIMINGS	57
5.5.1 - Single Scan	57
5.5.2 - Real Time	57
5.5.3 - Accumulate	58
5.5.4 - Kinetic Series & Accumulated Kinetic Series	59
5.6 - TRIGGERING MODES	60
5.6.1 - Internal	60
5.6.2 - External	60
5.6.3 - External Start	61
5.6.4 - Triggering type selection	61
5.7 - READOUT MODES	62
5.7.1 - Full Vertical Binning	63
5.7.2 - Single-Track	64
5.7.3 - Multi-Track (Standard)	65
5.7.4 - Custom Multi-Track	66
5.7.5 - Image	68
5.7.6 - Sub-Image	69
5.7.7 - Superpixels	70
5.7.8 - Readout Time	71
5.7.9 - Exposure Time v Shutter Time	72
5.7.10 - Delay	72
5.7.11 - Accumulate Cycle Time & No. of Accumulations	73
5.7.12 - Kinetic Series Length & Kinetic Cycle Time	73
5.8 - SHUTTER CONTROL	74
5.8.1 - Time to Open or Close	76
5.8.2 - Shutter Custom Settings	77
5.8.2.1 - During Background	77
5.8.2.2 - All other times	77
5.9 - COSMIC RAYS	78
5.10 - FILE INFORMATION	79

	<u>PAGE</u>
SECTION 6 - DISPLAYING DATA	80
6.1 - DISPLAY MODES	80
6.2 - AXIS DEFINITIONS	81
6.3 - DISPLAY PREFERENCES	82
6.3.1 - 2D Display Preferences	83
6.3.2 - Peak Search	84
6.3.2.1 - Peak Search Sensitivity	84
6.3.3 - Peak Labeling	84
6.3.3.1 - Labels on Peaks or Troughs	84
6.3.3.2 - Maximum Number of Labeled Peaks	84
6.3.3.3 - Format Labels	84
6.3.3.4 - Weighted Peak	84
6.3.3.5 - Pixel Peak	84
6.3.3.6 - Label peaks in all Overlaid Spectra	84
6.3.4 - 3D Display Preferences	85
6.3.5 - Image Display Mode Preferences	86
6.3.5.1 - Always Maintain Aspect Ratio On	86
6.3.5.2 - Always Maintain Aspect Ratio Off	86
6.3.5.3 - Show 2D Cross Sections	87
6.3.5.4 - Show Palette Bar	87
6.3.5.5 - Large cursor	87
6.4 - AXIS SETUP	88
6.5 - ZOOM BOX	89
6.6 - ZOOMING & SCROLLING	90
6.6.1 - Zoom In & Zoom Out	90
6.6.2 - Scrolling	90
6.6.3 - Reset	90
6.7 - 2D DISPLAY MODE	91
6.7.1 - 2D with Peak Labeling	92
6.7.2 - Overlay	93
6.7.2.1 - Active Trace	94
6.7.2.2 - Overlay & Keep	94
6.7.2.3 - Scale to Active	95
6.7.2.4 - Remove Overlay	95
6.8 - 3D DISPLAY MODE	96
6.9 - IMAGE DISPLAY MODE	97
6.9.1 - Palette Bar	98
6.9.2 - Selecting Color / Grayscale	99
6.9.3 - Rescale	100
6.9.4 - High & low contrast overview	102
6.9.4.1 - Increasing & decreasing contrast	103
6.9.5 - Brightness overview	104
6.9.5.1 - Adjusting the brightness	105

	<u>PAGE</u>
<u>SECTION 6 (continued)</u>	
6.10 - DATA HISTOGRAM	106
6.11 - REGION OF INTEREST	108
6.11.1 - ROI counter	111
6.11.2 - Hot Spot Approximation	111
6.11.3 - Recalculate	111
6.11.4 - Live update	111
6.11.5 - Maximum Scans	112
6.11.6 - Plot Series	112
6.12 - TIME STAMP	113
6.13 - PLAYBACK	114

	<u>PAGE</u>
SECTION 7 - HANDLING FILES	115
7.1 - MENU OPTIONS	115
7.1.1 - Open	116
7.1.2 - Close	117
7.1.3 - Save	117
7.1.4 - Save As	117
7.1.5 - Export As	118
7.1.5.1 - ASCII	120
7.1.5.2 - AVI	121
7.1.5.3 - BITMAP	121
7.1.5.4 - GRAMS	121
7.1.5.5 - JPEG	122
7.1.5.6 - MPEG	122
7.1.5.7 - Raw data	123
7.1.5.8 - TIFF	125
7.1.5.9 - Configuration Files	126
7.1.6 - Program selection	127

	<u>PAGE</u>
SECTION 8 - CALIBRATION	128
8.1 - INTRODUCTION TO CALIBRATION	128
8.2 - MANUAL X-CALIBRATION	129
8.2.1 - Supplying calibration details	129
8.2.2 - Applying calibration	130
8.2.3 - Calibrate	130
8.2.4 - When Manual X-Calibration goes wrong	130
8.2.4.1 - Data are Non-Monotonic	131
8.2.4.2 - Too few points	132
8.2.4.3 - Undo	132
8.2.4.4 - Close	132
8.3 - X-CALIBRATION BY SPECTROGRAPH	133
8.3.1 - Setup Spectrograph	134
8.3.1.1 - Calibrate As Red-Blue	134
8.3.2 - Communications	135
8.3.2.1 - Other spectrographs	135
8.3.2.2 - Reverse Spectrum	136
8.3.2.3 - X-Axis Labels & Units	136
8.3.2.4 - Change Units	137
8.3.2.5 - Center Wavelength / Center of Raman Shift	138
8.3.2.5.1 - Note on Raman Shift	138
8.3.2.6 - Offset	139
8.3.2.7 - Rayleigh Wavelength	139
8.3.2.8 - Micrometer Setting	140
8.3.2.9 - Grating	140
8.3.2.10 - Close	140
8.4 - PROCESSING DATA VIA THE COMMAND LINE	141
8.4.1 - Command Line	141
8.4.2 - Calculations	141
8.4.3 - Configure calculations	141

	<u>PAGE</u>
SECTION 9 - WORKING WITH PROGRAMS	142
9.1 - Working with Andor BASIC Programs	142
9.1.1 - Command Line	142
9.1.2 - Program Editor window	142
9.1.3 - Accessing the Edit functions	142
9.1.4 - Cut, Copy, Paste, Undo	143
9.1.5 - Search	143
9.1.6 - Replace	144
9.1.7- Run Program	144
9.1.8 - Run Program by Filename	145
9.1.9 - Entering program input	145

	<u>PAGE</u>
SECTION 10 - TUTORIAL	146
10.1 - CALIBRATING DATA USING FLUORESCENT ROOM LIGHT	146
10.1.1 - Aim & requirements	146
10.1.2 - Description	146

	<u>PAGE</u>
SECTION 11 - APPENDIX	149
A1.1 - GLOSSARY	149
A1.1.1 - CCD	150
A1.1.1.1 - Readout sequence of a CCD	151
A1.1.2 - Accumulation	152
A1.1.3 - Acquisition	152
A1.1.4 - A/D conversion	152
A1.1.5 - Background	152
A1.1.6 - Binning	152
A1.1.6.1 - Vertical Binning	153
A1.1.6.2 - Horizontal Binning (Creating Superpixels)	154
A1.1.7 - Counts	155
A1.1.8 - Dark Signal	155
A1.1.9 - Detection Limit	155
A1.1.10 - Exposure Time	156
A1.1.11 - Frame Transfer	156
A1.1.12 - Noise	157
A1.1.12.1 - Pixel noise	157
A1.1.12.2 - Fixed Pattern noise	157
A1.1.12.3 - Readout noise	157
A1.1.13 - Quantum Efficiency / Spectral Response	158
A1.1.14 - Readout	158
A1.1.15 - Saturation	158
A1.1.16 - Scan Types: Keep Clean & Acquired	158
A1.1.17 - Shift Register	159
A1.1.18 - Shot noise	159
A1.1.19 - Signal to Noise Ratio	159
A1.2 - ELECTRICAL RATINGS & ENVIRONMENTAL CONDITIONS	160
A1.3 - ADDITIONAL STATEMENT REGARDING EQUIPMENT OPERATION	160
A1.4 - MECHANICAL DIMENSIONS	161
A1.5 - TERMS & CONDITIONS	162
A1.6 - WARRANTIES & LIABILITY	163

SECTION 1 - ABOUT ANDOR CLASSIC PCI CCD

1.1 - INTRODUCTION TO THE ANDOR CLASSIC CCD

Firstly, thank you for choosing the Andor Classic **CCD** (Charge Coupled Device). From the outset, the CCD has been designed for ease of use. The detector head is compact, requires little maintenance, and fits easily to popular spectrographs. Under Andor Solis software control, it serves as both a multi-channel detector and a linear image sensor, catering for a broad range of applications.

1.2 - WORKING WITH THE USERS GUIDE

This User's Guide is your "road-map" to the Andor CCD software and hardware. In the software, all the controls you need for an operation are grouped and sequenced appropriately in on-screen windows.

As far as possible, the descriptions in this User's Guide are laid out in sections that mirror the Windows™ Interface and use standard Windows™ terminology to describe the features of the user interface.

If you are unfamiliar with Windows™, the documentation supplied with your Windows™ installation will give you a more comprehensive overview of the Windows™ environment.

1.3 - HELP

When the application is running, click the  button or press **F1** on the keyboard and the Andor Solis dialog box will open. Click on the area for which you require help and you will be provided with information relevant to the part of the application from which help was called. In addition to the main On-Line Help, the system provides help that relates specifically to the Andor Basic programming language. If you are working in a Program Editor Window, context sensitive help is available on the 'reserved words' of the programming language. To activate, with the cursor on or immediately after a reserved word, press **Ctrl + F1**.

So, whenever you're working with a particular window, you'll find a section in the User's Guide that sets that window in context, reminding you how the window is launched, letting you know what it can do, and telling you what other windows and operations are associated with it.

We hope you find use of our product rewarding. If you have any suggestions as to how our software, hardware and documentation might be improved, please let us know. You'll find the address of our nearest representative on **pages 16 - 17**.

The software provides **On-Line Help** typical of Windows™ applications

1.4 - DISCLAIMER

THE INFORMATION CONTAINED HEREIN IS PROVIDED "AS IS" WITHOUT WARRANTY, CONDITION OR REPRESENTATION OF ANY KIND, EITHER EXPRESS, IMPLIED, STATUTORY OR OTHERWISE, INCLUDING BUT NOT LIMITED TO, ANY WARRANTY OF MERCHANTABILITY, NON-INFRINGEMENT OR FITNESS FOR A PARTICULAR PURPOSE.

IN NO EVENT SHALL ANDOR BE LIABLE FOR ANY LOSS OR DAMAGE, WHETHER DIRECT, INDIRECT, SPECIAL, INCIDENTAL, CONSEQUENTIAL OR OTHERWISE HOWSOEVER CAUSED WHETHER ARISING IN CONTRACT TORT OR OTHERWISE, ARISING OUT OF OR IN CONNECTION WITH THE USE OF THE INFORMATION PROVIDED HEREIN.

1.5 - COPYRIGHT AND PROTECTIVE NOTICES

The copyright in this document and the associated drawings are the property of Andor Technology plc and all rights are reserved. This document and the associated drawings are issued on condition that they are not copied, reprinted or reproduced, nor their contents disclosed.

The publication of information in this documentation does not imply freedom from any patent or proprietary right of Andor Technology plc or any third party.

1.6 - TRADEMARKS AND PATENT INFORMATION

Andor, the Andor logo, Classic CCD and Solis are trademarks of Andor Technology plc.

All other marks are property of their owners.

Changes are periodically made to the product and these will be incorporated into new additions of the manual.

1.7 - TECHNICAL SUPPORT

Should you have any questions regarding the use of this equipment, please contact the representative from whom your system was purchased, or via one of the following locations:

1.7.1 - Europe	1.7.2 - USA
<p align="center"> Andor Technology 7 Millennium Way Springvale Business Park Belfast BT12 7AL Northern Ireland Tel. +44 (0) 28 9023 7126 Fax. +44 (0) 28 9031 0792 e-mail: productsupport@andor.com </p>	<p align="center"> Andor Technology 425 Sullivan Avenue Suite # 3 South Windsor CT 06074, USA Tel. (860) 290-9211 Fax. (860) 290-9566 e-mail: productsupport@andor.com </p>
1.7.3 - Asia-Pacific	1.7.4 - China
<p align="center"> Andor Technology (Japan) 7F Ichibancho Central Building 22-1 Ichiban-Cho Chiyoda-Ku Tokyo 102-0082 Japan Tel. +81 3 3511 0659 Fax. +81 3 35110662 e-mail: productsupport@andor.com </p>	<p align="center"> Andor Technology Room 1116 Zhejiang Building No. 26 An Zhen Xi Li Section 3 Chaoyang District Beijing 100029 China Tel. +86-10-5129-4977 Fax. +86-10-6445-5401 e-mail: productsupport@andor.com </p>

1.8 - WORLDWIDE DISTRIBUTORS

Country/Region	Contact	Phone Number	e-mail
Australia (I)	Mr Con Sapounas	00 61 39416 9959	con@scitech.com.au
Belgium, Luxembourg, Netherlands (S)	Mr Olaf Koschuetzke	00 49 6151 88060	koschuetzke@lot-oriel.de
China (S/I)	Mr Depei Wang	00 86 10 649 71708	dwang@bost-ltd.com
Denmark (S)	Mr Michael Lund	00 45 3930 0403	michael.lund@azpect.se
France	Miss Elvyne Egrot	0033 1 69194949	egrot@lot-oriel.fr
Germany (I)	Mr Gerhard Haurert	00 49 89 8901 3523	gerhard.haurert@bfioptilas.avnet.com
Germany (S)	Mr Olaf Koschuetzke	00 49 6151 88060	koschuetzke@lot-oriel.de
Hong Kong	Ms Judy Chang	00 852 2810 6090	judy@teltec.biz
India (S/I)	Mrs Kaveri Mukherjee	00 91 805534004	specmco@vsnl.com
Israel (S/I)	Mr Moti Zvi	00 972 3635 6650	moti@newteh.co.il
Italy (S,I)	Mr Paolo Antonucci	00 39 06 500 4204	antonucci@lot-oriel.it
Poland	Mr Henryk Dluzewski	0048 32 342 0666	Dluzewski@lot-oriel.com
Portugal (S)	Mr Pedro Fernandes	00 351 218 150760	biodin@individual.eunet.pt
Singapore (S)	Mr Justin Kow	00 65 6734 8619	justinkow@teltecpacific.com
South Africa	Dr Maurice McDowell	00 27 12 348 0569	ceo@measureit.co.za
South Korea (S/I)	Mr Dong Hyun Kim	00 82 31 765 0300	optron@optron.co.kr
South Korea (S/I)	Mr Ji-Soung Park	00 82 2 587 4369	jspark@hkic.co.kr
Spain (S)	Ms Paloma Gonzalez	00 34 91 806 4390	info@iberlaser.com
Switzerland (S/I)	Mr Andre Galliker	00 41 21 869 90 33	galliker@lot-oriel.com
Taiwan (S/I)	Mr Richard Lin	00 886 3 485 2036	richard@mrmanotec.com
Turkey	Mr Akan Sahin	00 90 312 472 5390	aksahin@globalanalitik.com.tr

S = Spectroscopy Cameras

I = Imaging Cameras

(Details correct at time of going to print)

1.9 - COMPONENTS

The main components of the Andor CCD system are as follows:

- Detector Head (more commonly known as a **Camera**)
- Plug-In Card: PCI format
- Cable: Detector Head to Controller Card
- Andor Solis Software: CD format
- Classic PCI CCD User's Guide (this manual)
- Andor Basic Programmer's Guide

1.9.1 - Optional extras

- Multiple I/O boxes IO160 & IO165 (optional, but highly recommended)
- PS150 **P**ower **S**upply **U**nit (**PSU**) and cable (recommended for maximum cooling)
- Spectrograph
- Mounting Flanges
- C-Mount Lens
- C-Mount Lens Adaptor
- Nikon F-Mount Lens Adaptor with Shutter

A typical **Detector Head** (or **Camera** - see **figure 1**) contains the following items:

- CCD Sensor
- Pre-Amplifier
- Cooling circuitry
- Input / output connector
- Water pipe connectors

The camera can be attached to a Spectrograph or other optical device for acquiring data.



Figure 1: Typical Classic PCI CCD Cameras: DU434 Series camera for Spectroscopy (left), DV437 Series for Imaging (right)

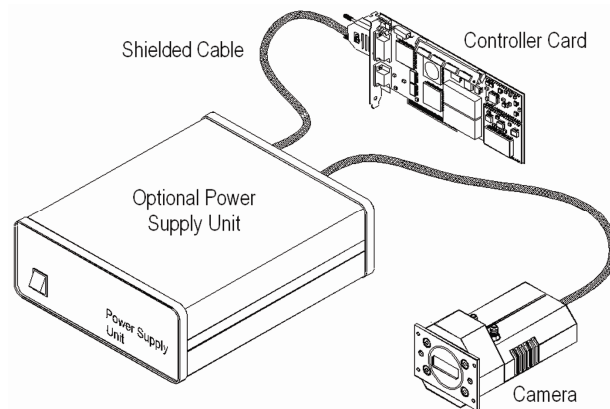

Figure 2: Typical components of Andor CCD systems

NOTE: The two water pipe connectors allow water to be passed through the head to assist cooling as required.

1.9.2.1 - Rear connector



Figure 3: CCD rear connector

There is one connector on the rear of the Camera as shown above. This is connected to the PCI Controller Card (see next page for further details) using the cable shown in **figure 4** below.

1.9.2.2 - Detector Head to Controller Card Cable

The cable that connects the detector head to the Controller Card uses 26 pin (High Density) D connectors:



Figure 4: Controller Card cable

It is well shielded against electrical interference and can be between 3m – 10m long.

1.9.2.3 - PCI Controller Card

The PCI Controller Card contains analog-to-digital converters which digitize analog data from the detector head. Under software control this data is transferred to the computer, where they are stored in computer memory. The card requires one PCI slot.

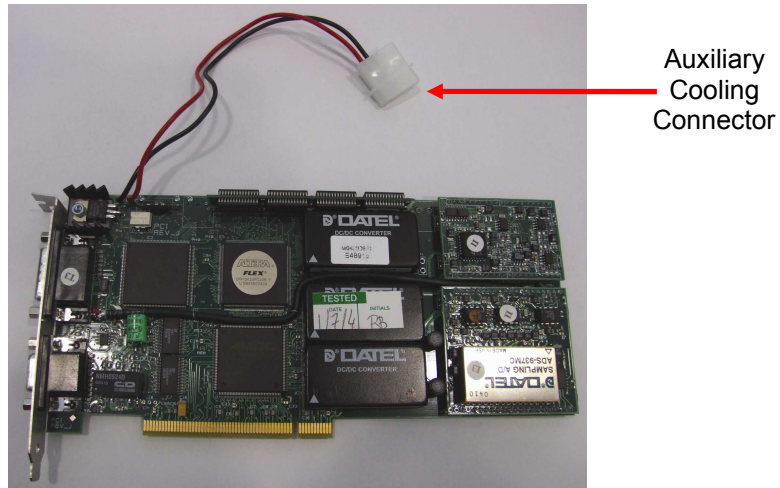
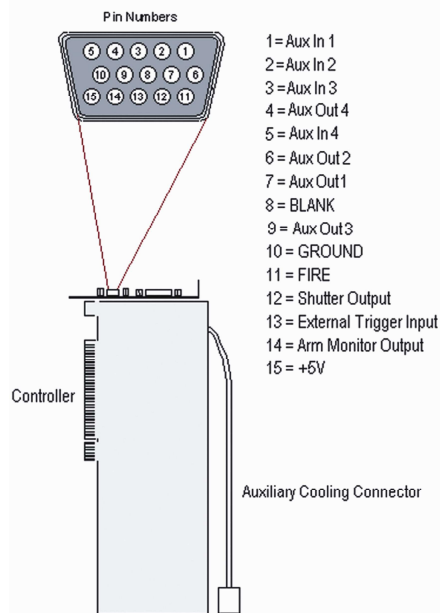

Figure 5: PCI Controller Card

CONTROLLER CARD - AUXILIARY CONNECTOR PINOUTS



19.2.4 - Auxiliary Cooling Connector

The Auxiliary Cooling Connector attached to the plug-in PCI controller card should also be used to connect the controller card directly to the internal power supply of the computer. This allows more current to be drawn to the TE cooler in the detector head, than is possible through the controller card slot (please refer to **Installing the Controller Card** on page 33).

The auxiliary cooling connector uses the standard auxiliary power connectors available in all desktop and some portable computers. It achieves minimum operating temperatures that are typically 10°C to 15°C higher than those you will obtain by using the external PSU box. When the auxiliary cooling connector is attached, the current automatically switches to it. You do not have to set any switches or jumpers.

1.9.2.5 - IO160 Multiple Input/Output Box

The optional IO160 Multiple I/O (Input/Output) Box plugs into the Auxiliary Connector on the Controller Card. It is required for use with an external shutter and to provide additional I/O control.

The I/O Accessory is a 'break-out box', on which separate BNC sockets (each of which is appropriately labeled) correspond to pins on the Auxiliary Connector. The break-out box is fully opto-isolated to reduce interference and is powered from the PCI slot of the computer (i.e. no mains power is required).



Figure 6: IO160 Multi I/O Box

The connections and pin-outs for the IO160 are shown on the next page.

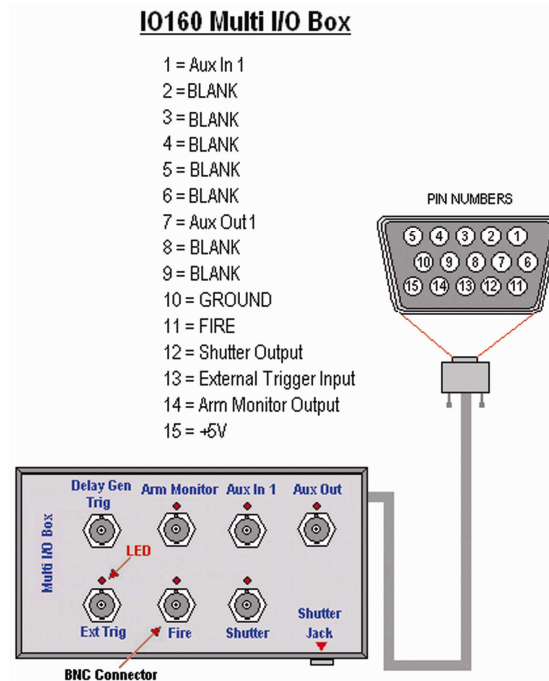

CONNECTION	DESCRIPTION OF FUNCTION
Aux Out 1	Auxout1 Output is an SN74128, 50Ω, TTL driver that can be controlled through the Andor Basic programming language.
Aux In 1	Auxin1 Input is a standard 74LS, TTL input that can be read through Andor Basic.
Arm Monitor & Delay Gen Trig	The Arm Monitor and Delay Gen Trig Outputs (both of which are advanced CMOS (AC) logic outputs) apply only to ICCD operation and are used, in conjunction with the Ext Trig input, for synchronization to pulsed sources (e.g. pulsed laser).
Ext Trig	When the software is set to External triggering (see Setup Acquisition in Section 4), a positive edge on the Ext Trig Input triggers the beginning of the acquisition. Ext Trig is a TTL-Compatible Advanced CMOS input (ACT) with 470Ω input resistance.
Fire	The Fire Output, an SN74128, 50Ω, TTL driver, indicates the period during which it is appropriate to allow light to fall on the detector (to prevent smearing) It is driven in both Internal and External trigger modes. The duration indicates the actual exposure time of the acquisition and is controlled by the parameters you have entered on the Setup Acquisition dialog box. Typically, the leading edge of the Fire output is used to trigger external sources (e.g. a pulsed laser) when you are working in Internal trigger mode.
Shutter	The Shutter Output (an SN74128, 50Ω, TTL driver) is used when you are acquiring background data, or when you are acquiring data in Multi-Track or Imaging modes. Its operation can be fully controlled from the Shutter Control dialog box.
Shutter (30v)	The Shutter Output Jack (30V 'on' pulse with 5V hold) produces the same signal as the TTL Shutter output above, but is capable of directly driving a suitable mechanical shutter at up to 0.5 Hz. (Shutter # LMS-NF is an appropriate device which can be mounted on the standard Andor faceplate and accepts a Nikon 'F' lens.) The connection uses a 0.3mm sub-miniature 3-pole (stereo) jack plug to prevent confusion with other equipment.

1.9.2.6 - IO165 Advanced Multi I/O Box

A more advanced version of the IO160, the IO165 (shown below) is also available as an option. This has all of the functions of the IO160 combined with an additional 16 TTL (Transistor - Transistor Logic) outputs, 8 TTL inputs, ADC & DAC control.



Figure 7: IO165 Advanced Multi I/O Box

1.9.2.6.1 - IO165 Connections & Pin-outs

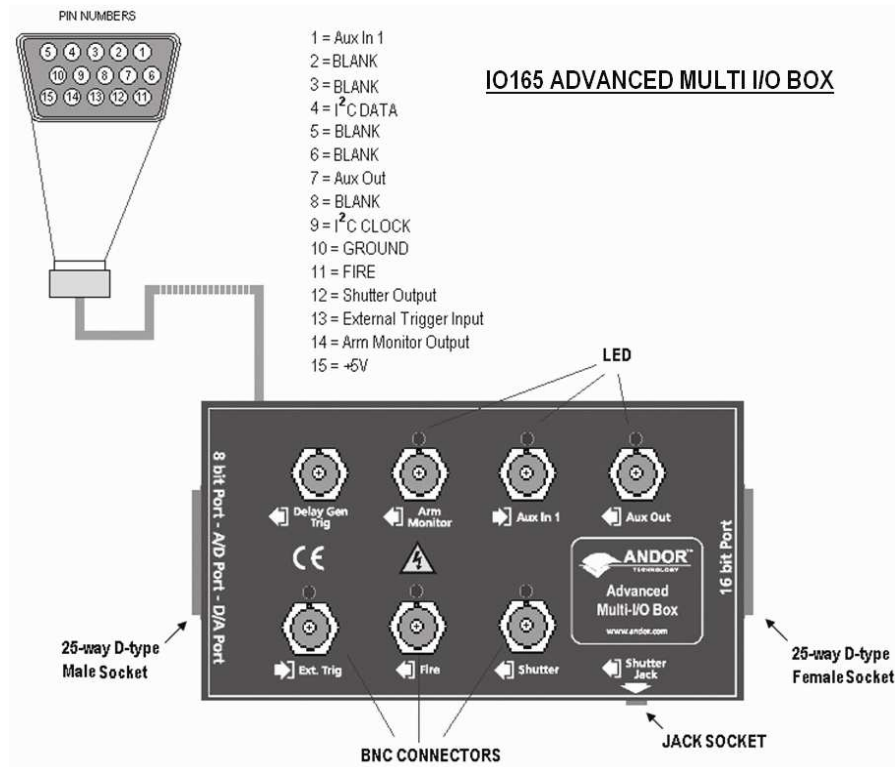

1.9.3 - Optional Spectrograph

- A Spectrograph is usually required for spectroscopic measurements. A spectrograph and CCD combination (an optical spectral analyzer) may be used to replace the traditional motor-driven monochromator and photomultiplier tube. In a spectrograph, a wide aperture replaces the exit slit found in the monochromator.
- The spectrograph causes a dispersed spectrum to be projected as a continuous band of wavelengths on to a CCD at the focal plane.
- In order that the detector head can be positioned at the focal plane, the correct mounting flange must be attached to the spectrograph. In addition, you must ensure that an appropriate entry slit and grating are used for the particular spectral analysis you want to undertake.

1.9.4 - Optional Mounting Flanges

- Mounting Flanges, or face plates, are metal plates which allow the detector head to be positioned at the focal plane of a spectrograph.
- Andor can provide mounting flanges for a wide range of spectrographs, in imaging and non-imaging format, with focal lengths ranging from 125cm to 1m if required.
- Consult the spectrograph's instruction manual to ensure that you are using the correct flange.

1.9.5 - Software

Software is supplied on a CD or USB stick.

1.10 - COOLING

The CCD is cooled using a thermoelectric (**TE**) cooler. TE coolers are small, electrically powered devices with no moving parts, making them reliable and convenient. A TE cooler is actually a heat pump, i.e. it achieves a temperature difference by transferring heat from its 'cold side' (the CCD-chip) to its 'hot side' (the built-in heat sink). Therefore the minimum absolute operating temperature of the CCD depends on the temperature of the heat sink. The vacuum design means that we can achieve a maximum temperature difference of over 110°C, a performance unrivalled by other systems. The maximum temperature difference that a TE device can attain is dependent on the following factors:

- Heat load created by the CCD
- Number of cooling stages of the TE cooler
- Operating current.
- The heat that builds up on the heat sink must be removed and this can be done in one of two ways:
 1. **Air cooling:** a small built-in fan forces air over the heat sink.
 2. **Water cooling:** external water is circulated through the heat sink using the water connectors on the top of the head.

All Andor CCD systems support both cooling options. Whichever method is being used, it is not desirable for the operating temperature of the CCD simply to be dependant on or vary with the heat sink temperature. Therefore a temperature sensor on the CCD, combined with a feedback circuit that controls the operating current of the cooler, allows stabilisation of the CCD to any desired temperature within the cooler operating range. As well as a choice of cooling method there is also a choice of performance versus price.

1.10.1 - Air cooling performance

Air cooling is the most convenient method of cooling, but it will not achieve as low an operating temperature as water cooling (see below). Even with a fan (see **NOTE 1.** below), a heat sink typically needs to be 10°C hotter than the air (room) temperature to transfer heat efficiently to the surrounding air. Therefore the minimum CCD temperature that can be achieved will be dependent on the room temperature.

The table below is a guide to the minimum achievable operating temperatures for various room temperatures. Performance of individual systems will vary slightly.

Air Temp	Evacuated housing with:					
	Ultra-High Performance Cooling			High Performance Cooling		
	External PSU Box	Flying Lead	Slot Only	External PSU Box	Flying Lead	Slot Only
20°C	-75°C	-65°C	-56°C	-65°C	-57°C	-42°C
25°C	-73°C	-63°C	-54°C	-63°C	-55°C	-40°C
30°C	-71°C	-61°C	-52°C	-61°C	-53°C	-38°C

NOTES

1. The fan does not operate until the heat sink temperature has reached between 20°C and 22°C. It is therefore quite normal for the fan not to operate when the system is first switched on.
2. The relationship between the air temperature and the minimum CCD temperature in the table is not linear. This is because TE coolers become less efficient as they get colder.

1.10.2 - Water cooling performance

A flow of water through the heat sink removes heat very efficiently, since the heat sink is never more than 1°C hotter than the water. With this type of cooling, the minimum temperature of the CCD will be dependent only on the water temperature not on the room temperature.

The table below is a guide to the minimum achievable operating temperatures for various water temperatures. Performance of individual systems will vary slightly.

Water Temp	Evacuated housing with:					
	Ultra-High Performance Cooling			High Performance Cooling		
	External PSU Box	Flying Lead	Slot Only	External PSU Box	Flying Lead	Slot Only
10°C	-90°C	-80°C	-61°C	-80°C	-68°C	-48°C
15°C	-88°C	-78°C	-59°C	-78°C	-66°C	-46°C
20°C	-86°C	-76°C	-57°C	-76°C	-64°C	-44°C
25°C	-84°C	-74°C	-55°C	-74°C	-62°C	-42°C

Water cooling, either chilled through a refrigeration process or re-circulated (which is water that is forced-air cooled then pumped) allows lower minimum operating temperatures than air cooling. However, there is a very important point relating to chilled water cooling. If the water temperature is lower than the dew point of the room, condensation will occur on the heat sink, the water taps and other metal parts of the head. This will quickly destroy the head and must never be allowed to happen. However this is not an issue when using a Recirculator which eliminates the dew point problem.

NEVER USE COOLING WATER THAT IS COLDER THAN THE DEW POINT OF THE AIR IN THE ROOM. DAMAGE CAUSED IN THIS WAY IS NOT COVERED BY THE WARRANTY.

1.10.3 - Cooling with External Power Supply Unit

An external PSU (the PS150) can supply the greatest permissible current to the cooler, resulting in the lowest temperature performances:

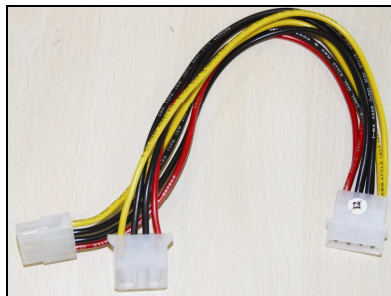

Figure 8: PS150 Power Supply

For most systems the PS150 can be considered as an option. You may purchase it at a later date to enhance performance.

1.10.4 - Cooling with Plug-In Card only

Power for the cooling circuit can be drawn through the card slot alone. Portables and some portable computers do not support direct connections to their power supplies, so using the card slot connection may be the only option. Where this no spare power supply connection available on a PC, the additional power splitter shown here can be used:



Even so, our vacuum systems have such a small heat load that, even in any of these configurations, they still outperform most other, larger systems on the market.

1.11 - SAFETY PRECAUTIONS**1.11.1 - Care of the Detector Head**

THERE ARE NO USER-SERVICEABLE PARTS INSIDE THE DETECTOR HEAD AND A NUMBER OF SCREWS ON THE DETECTOR HEAD HAVE BEEN MARKED WITH RED PAINT TO PREVENT TAMPERING. IF YOU ADJUST THESE SCREWS YOUR WARRANTY WILL BE VOID.

YOUR DETECTOR IS A PRECISION SCIENTIFIC INSTRUMENT CONTAINING FRAGILE COMPONENTS. ALWAYS HANDLE THE DETECTOR WITH CARE

1.11.2 - Working with electronics

- The computer equipment that is to be used to operate the CCD Detector should be fitted with appropriate surge/EMI/RFI protection on all power lines. Dedicated power lines or line isolation may be required for some extremely noisy sites.
- Appropriate static control procedures should be used during the installation of the system. Attention should be given to grounding.
- The circuits used in the detector head are extremely sensitive to static electricity and radiated electromagnetic fields, and therefore they should neither be used nor stored in close proximity to EMI/RFI generators, electrostatic field generators, electromagnetic or radioactive devices, or other similar sources of high energy fields.
- Some examples of equipment which can cause problems are plasma sources, arc welders, radio frequency generators, X-ray instruments, and pulsed discharge optical sources.
- Operation of the system close to intense pulsed sources (lasers, xenon strobes, arc lamps, and the like) may compromise performance if shielding is inadequate.

1.11.3 - Condensation

NEVER USE WATER THAT HAS BEEN CHILLED BELOW THE DEW POINT OF THE AMBIENT ENVIRONMENT TO COOL THE DETECTOR. You may see condensation on the outside of the detector body if the cooling water is at too low a temperature or if the water flow is too great. The first signs of condensation will usually be visible around the water connectors where the water tubes are attached. In such circumstances switch off the system, and wipe the detector head with a soft, dry cloth.

It is likely there will already be condensation on the cooling block and cooling fins inside the detector head. Set the detector head aside to dry for several hours before you attempt reuse.

Before reuse blow dry gas through the cooling slits on the side of the detector head to remove any residual moisture. Use warmer water or reduce the flow of water when you start using the device again.

PLEASE REFER TO COOLING ON PAGES 26 - 29 FOR DETAILS OF MINIMUM ACHIEVABLE TEMPERATURES, AND IMPORTANT ADVICE ON AVOIDING OVERHEATING.

1.11.4 - Head overheating

Whichever cooling method you are using, make sure that the detector head does not overheat, as this can cause system failure. Overheating may occur if either of the following occur:

- The air vents on the sides of the head are accidentally blocked or there is insufficient or no water flow
- The ambient air temperature is over 20°C

To protect the detector from overheating, a thermal switch has been attached to the heat sink. If the temperature of the heat sink rises above 47°C, the current supply to the cooler will cut out and a buzzer will sound. Once the head has cooled, the cut-out will automatically reset. It is not recommended that for the camera to be operated under these conditions for extended periods of time.

NOTE: Never obstruct the air vents on the detector head.

SECTION 2 - INSTALLATION**2.1 - INSTALLING THE HARDWARE****2.1.1 - Computer requirements**

The minimum computer requirement for correct CCD operation is as follows:

- 800MHz Pentium Processor with 256MB RAM
- Windows 2000 or XP
- PCI card slot
- 25MB of free hard disc space

2.2 - INSTALLING THE CONTROLLER CARD

The PCI Controller Card is installed as per most other slot-in PC cards (e.g. graphics cards or parallel printer adapter cards). With PCI cards there are no jumpers for you to set, i.e. the card is **Plug and Play** compatible.

NOTE: We recommend you first consult the manual supplied with your personal computer to ensure correct installation of the controller card for your particular PC.

The installation should be installed in a similar manner to the following:

1. Exit the computer's operating system and switch off the computer and its accessories.
2. Unplug the computer and any accessories from the wall outlet(s).
3. Unplug all cables from the rear of the computer
4. Unscrew any cover mounting screws on the computer and set them aside safely.
5. Gently remove the cover of the computer.
6. Situated inside the personal computer are a number of **Expansion Slots**. The Controller Card can be installed in any PCI slot that has bus master capability. Having decided which slot you are going to use, remove the Metal Filler Bracket (a narrow blank metal plate held in place by a single screw) that normally covers the opening for the slot at the back of the computer. Keep the retaining screw safe as you will need it later in the installation procedure.
7. **IMPORTANT NOTE: AT THIS POINT PUT ON THE ESD WRIST STRAP SUPPLIED WITH YOUR CAMERA AND ENSURE YOU WEAR IT AT ALL TIMES WHEN HANDLING THE CARD.** You are now ready to install the Controller Card.
8. Whilst observing appropriate static control procedures (please see **Working with electronics on page 30**), firmly press the connector on the long edge of the card into the chosen expansion slot, so that the card's metal mounting bracket (located at the end of the card and bearing the connectors for the detector head and the multiple I/O adapter) is next to the opening on the back panel of the computer.
9. Making sure that the card's mounting bracket is flush with any other mounting brackets or filler brackets to either side of it, use the screw that you removed from the filler bracket earlier to secure the PCI Controller Card in place.
10. Connect the Auxiliary Cooling Connector of the controller card to one of the standard auxiliary connectors from the computer power supply.
11. Replace the cover of the computer and secure it with the mounting screws.
12. Reconnect any accessories you were using previously.

2.3 - CONNECTING THE SYSTEM

1. Plug your PC into the mains outlet to ensure grounding, but keep the power switched off.
2. Connect the Detector Head to the Controller Card using the Cable provided. The 26-pin “D” connectors on the cable are polarized so that there is only one way of installing the cable.
3. Secure the cable by tightening the locking screws at both ends (finger tight only). It is important that this cable is securely fastened to provide a good grounding between the detector head and Controller Card.

If your system has the optional PSU for maximum cooling, two connector cables are supplied, each terminated by 26-pin “D” connectors. Again, the polarization of the connectors ensures that there is only one way of installing the cables. Use one cable to connect the detector to the **To Head** socket of the PSU. Use the second cable to connect the Controller Card to the **To Controller** socket of the PSU. For best performance the PSU should be plugged into the same power source as the computer.

NOTES:

1. **The optional PS150 has a thermal cut-out to deactivate the unit if it overheats and a buzzer will also sound. Press the button on the underside of the PS150 device to reset it and raise the temperature setting on the software’s temperature control dialogue box to reduce the load on the PS150**
2. **Never block the air vents on the camera**

2.4 - INSTALLING THE SOFTWARE

2.4.1 - Windows 2000/XP

1. Insert the Andor CD. The 'installation wizard' should start. If it does not start automatically, run the file **setup.exe** from the CD.
2. Follow the on-screen prompts until you are asked to restart the system, when you should enter **No**. Since the Windows 2000/XP operating system is not fully Plug and Play aware, you must install the driver manually.
3. Run the **install.bat** file from the Andor CD
4. Restart the computer
5. Run the Andor application. From the PC desktop select **Start...Programs...Andor Solis...Andor Solis**

You are now ready to make a data acquisition.

SECTION 3 - USING THE CCD

3.1 - STARTING THE APPLICATION

On the desktop, click on the  icon and the Solis 'Splash Screen' appears briefly, e.g.:





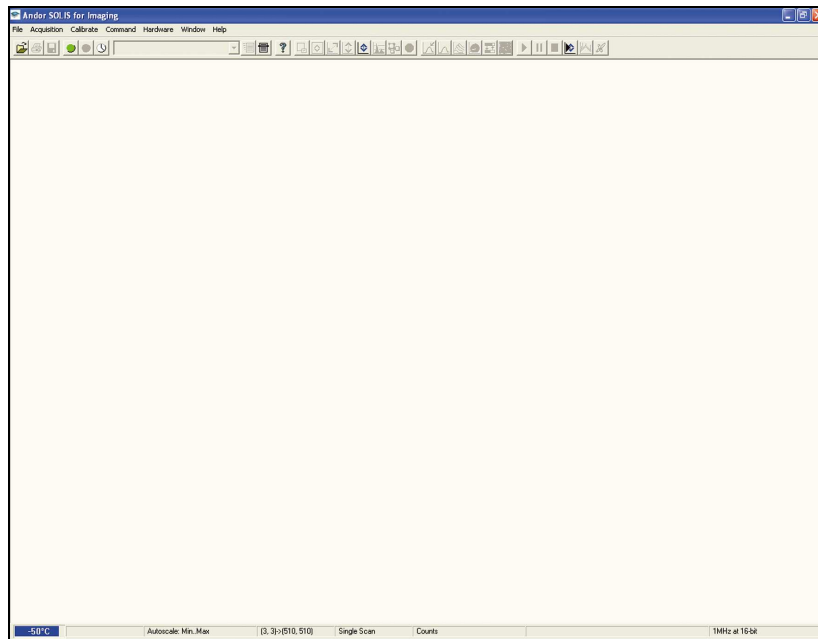



























The Main Window then appears, e.g.:



3.2 - MAIN WINDOW

The Main Window is your “entry point” to the system. The menu options that you select from either execute functions directly, or launch further windows/dialog boxes that let you select the functionality you require. Some menu options on the Main Window are also represented as easy-to-use radio buttons, as shown in **Table 1** below.

Table 1: Main Window buttons

ICON	TITLE	ICON	TITLE	ICON	TITLE
	OPEN		RESET		TIME STAMP
	PRINT		RESCALE		PLAY
	SAVE		ACQUISITION AUTOSCALE #0		PAUSE
	TAKE SIGNAL		DATA HISTOGRAM		STOP
	ABORT ACQUISITION		REGION OF INTEREST		PLAYBACK AUTOSCALE OFF
	SETUP ACQUISITION		FILE INFORMATION		BASELINE (NOT USED)
	RUN PROGRAM		2D DISPLAY WITH PEAK LABELS		PERIODIC TABLE
	COMMAND LINE		2D DISPLAY		TEMPERATURE CONTROL (OFF)
	CONTENTS		3D DISPLAY		TEMPERATURE CONTROL (ON)
	SELECT SUBIMAGE AREA		IMAGE DISPLAY		
	SELECT AUTOSCALE AREA		CHANGE FALSE COLOR PALETTE		

NOTE: Some menu titles and buttons appear on the main window only under certain circumstances as shown on the next page.

- The Display menu and its associated buttons will not appear until you open a Data Window, e.g.:

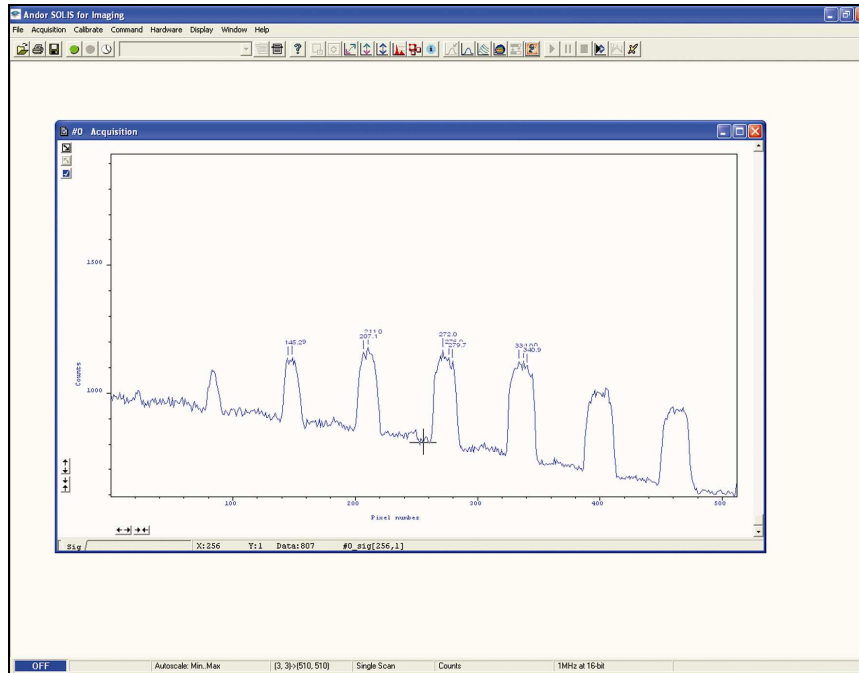

- The Edit & Search menus and their associated buttons appear only when a Program Editor Window is active, e.g.:

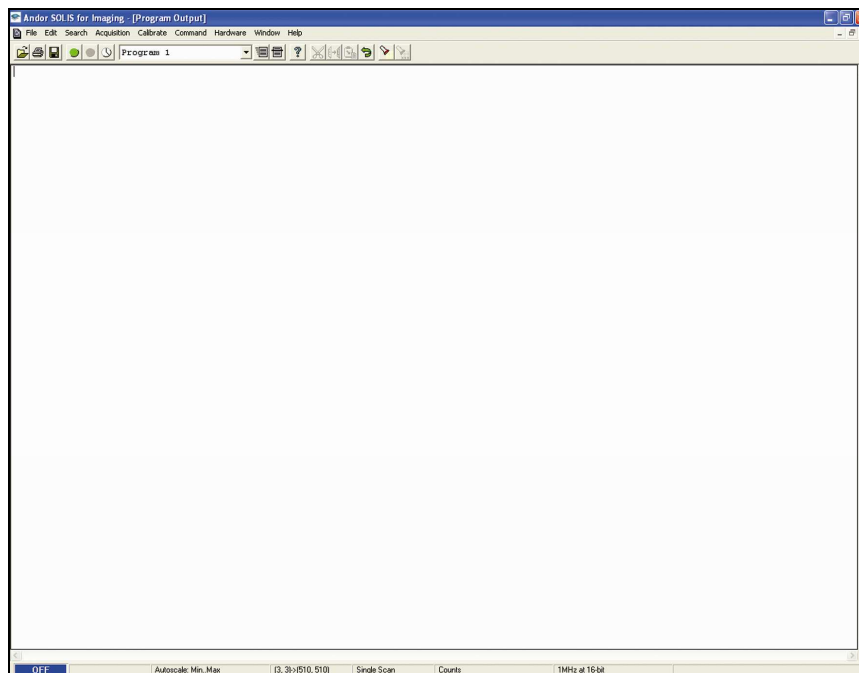

3.3 - HOT KEYS

Hot keys (or shortcuts) as shown in Tables 2, 3 & 4 enable you to work with the system directly from the keyboard, rather than via the mouse.

Table 2: Data Acquisition Hot Keys

KEY STROKE	DESCRIPTION
F5	Take signal
F6	Autoscale Acquisition
Ctrl + B	Take background
Ctrl + R	Take reference
Esc	Abort Acquisition

Table 3: Data Window Hot Keys

KEY STROKES	DESCRIPTION	DISPLAY MODE		
		2D	3D	IMAGE
+	Expand ('Stretch') data-axis	✓	✓	✓
-	Contract ('Shrink') data-axis	✓	✓	✓
Ins	If maintain aspect ratio off, expand x-axis. If maintain aspect ratio on, expand x-axis and y-axis	✓	✓	✓
Del	If maintain aspect ratio off, contract x-axis. If maintain aspect ratio on, contract x-axis and y-axis.	✓	✓	✓
/	On image, if maintain aspect ratio off, expand y-axis. On image, if maintain aspect ratio on, expand x-axis and y-axis			✓
Home	Move cursor furthest left	✓	✓	✓
End	Move cursor furthest right	✓	✓	✓
PgUp	Scroll up through tracks	✓	✓	
PgDn	Scroll down through tracks	✓	✓	
Shift + PgUp	Move to next image in series	✓	✓	✓
Shift + PgDn	Move to previous image in series	✓	✓	✓
Left Arrow	Move cursor left	✓	✓	✓
Right Arrow	Move cursor right	✓	✓	✓
Up Arrow	Scroll trace up (on image: move cursor up)	✓	✓	✓
Down Arrow	Scroll trace down (on image: move cursor down)	✓	✓	✓
Shift + Left Arrow	Scroll trace/image left	✓	✓	✓
Shift + Right	Scroll trace/image right	✓	✓	✓
Ctrl + Left Arrow	Peak search left	✓		
Ctrl + Right Arrow	Peak search right	✓		

Table 3:– Data Window Hot Keys (continued)

KEY STROKES	DESCRIPTION	DISPLAY MODE		
		2D	3D	IMAGE
Left Arrow	Move cursor left	✓	✓	✓
Right Arrow	Move cursor right	✓	✓	✓
Up Arrow	Scroll trace up (on image: move cursor up)	✓	✓	✓
Down Arrow	Scroll trace down (on image: move cursor down)	✓	✓	✓
Shift + Left Arrow	Scroll trace/image left	✓	✓	✓
Shift + Right Arrow	Scroll trace/image right	✓	✓	✓
Ctrl + Left Arrow	Peak search left	✓	✓	✓
Ctrl + Right Arrow	Peak search right	✓	✓	✓
F7	Toggle Palette			✓
F8	Reset	✓	✓	✓
F9	Rescale	✓	✓	✓
Alt + F9	Toggle Rescale Mode	✓	✓	✓
Ctrl + F9	Scale to Active (See Displaying Data section)	✓		
F10	File information	✓	✓	✓

Table 4: Andor Basic Programming Language Hot Keys

KEY	DESCRIPTION
Ctrl + P	New program
Ctrl + E	Run program
Esc	Abort acquisition / program
Ctrl + L	Command line
Ctrl + F1	Context sensitive help on reserved words in the Andor Basic programming language is available if you are using the Program Editor Window.

SECTION 4 - PRE-ACQUISITION

4.1 - SETTING TEMPERATURE

For accurate readings, the CCD should first be cooled, as this will help reduce dark signal and associated shot noise. To do this, either select the Temperature option from the Hardware drop-down menu on the Main Window:

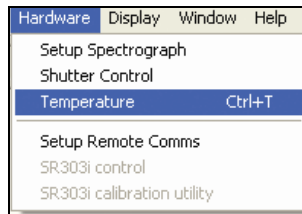

Alternatively, click the **OFF** button in the bottom-left of the screen.

This will open up the **Temperature Control** dialog box :

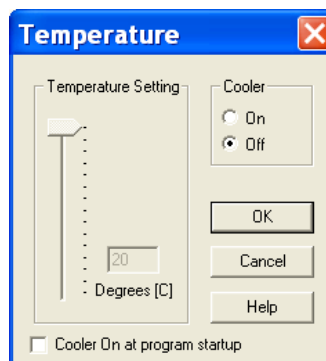

Select **On** in the **Cooler** check box.

The Degrees (C) field in the Temperature Setting section will now be highlighted in blue and the Cooler will be indicated as **On** as shown below. To adjust the temperature, either type in the new figure in the Degrees (C) box or slide the arrowed bar down or up.

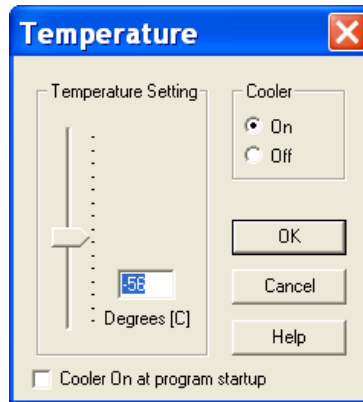

Once the desired temperature has been selected, click **OK**. The dialog box will disappear and the **Temperature Control** button in the bottom-left of the screen will show the current temperature highlighted in red e.g.:



This figure will change as the head cools. Once the head has reached the desired temperature, the highlighted area changes to blue.

You can also select the option to have the Cooler switched on as soon as you start the application. This is selectable in the bottom-left of the Temperature dialog box.

PLEASE REFER TO COOLING ON PAGES 26 - 29 FOR DETAILS OF MINIMUM ACHIEVABLE TEMPERATURES, AND IMPORTANT ADVICE ON AVOIDING OVERHEATING.

4.2 - SETUP ACQUISITION

To select the mode of acquisition prior to data capture, you can either click the  button, key in **Ctrl+A** from the keyboard or select **Setup Acquisition** from the **Acquisition** drop-down menu:



The Setup Acquisition Dialog box appears, e.g.:

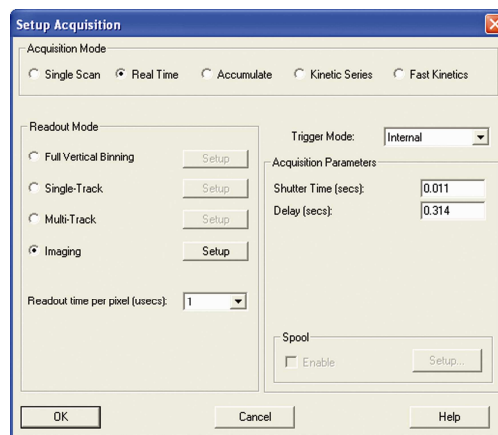

The following options are available in the Setup CCD area:

<u>ACQUISITION MODE</u>	<u>TRIGGERING</u>
Single Scan	Internal
Accumulate	External
Kinetic Series	External Start
Fast Kinetics	
<u>READOUT MODE</u>	<u>READOUT TIME PER PIXEL (µsecs)</u>
FVB (Full Vertical Binning)	1
Single-Track	2
Multi-Track	16
Imaging	32 2x Gain

4.2.1 - Acquisition & Readout Mode combinations

Certain text boxes become active as you select each Acquisition Mode. Minimum default values are also shown in the text boxes. These are shown in the tables on this page and the next.

Acquisition mode	Readout mode	Exposure time (secs)	Shutter time (secs)	Delay (secs)	Readout time per pixel (µsecs)	Fast Triggering	Trigger Modes
Single Scan	Full Vertical Binning	✓			✓	Only available in External Trigger mode	Internal or External
	Single-Track		✓	✓	✓	Only available in External Trigger mode	Internal or External
	Multi-Track		✓	✓	✓	Only available in External Trigger mode	Internal or External
	Imaging		✓	✓	✓	Only available in External Trigger mode	Internal or External
Real Time (FVB)	Full Vertical Binning	✓	✓	✓	✓	Only available in External Trigger mode	Internal or External
	Single-Track		✓	✓	✓	Only available in External Trigger mode	Internal or External
	Multi-Track		✓	✓	✓	Only available in External Trigger mode	Internal or External
	Imaging		✓	✓	✓	Only available in External Trigger mode	Internal or External

Acquisition mode	Readout mode	Exposure time (secs)	Shutter time (ses)	Number of Accumulations	Number in Kinetic Series	Fast Triggering	Trigger Modes
Accumulate	Full Vertical Binning	✓		✓		Only available in External Trigger mode	Internal or External
	Single-Track		✓	✓		Only available in External Trigger mode	Internal or External
	Multi-Track		✓	✓		Only available in External Trigger mode	Internal or External
	Imaging		✓	✓		Only available in External Trigger mode	Internal or External
Kinetic Series	Full Vertical Binning	✓		✓	✓	Only available in External Trigger mode	Internal or External
	Single-Track		✓	✓	✓	Only available in External Trigger mode	Internal or External
	Multi-Track		✓	✓	✓	Only available in External Trigger mode	Internal or External
	Imaging		✓	✓	✓	Only available in External Trigger mode	Internal or External

Acquisition mode	Readout mode	Sub-area Height (in rows)	Exposure Time (µsecs)	Number in Series	Trigger Modes
Fast Kinetics	Full Vertical Binning	✓	✓	✓	Internal, External or External Start
	Imaging	✓	✓	✓	Internal, External or External Start

4.3 - AUTO-SAVE

Auto-Save allows you to set parameters and controls for the auto saving of acquisition files thus removing the worry of lost data and files. To select, click on the Auto-Save tab in the Setup Acquisition dialog box .The Auto-save dialog box appears, e.g.:

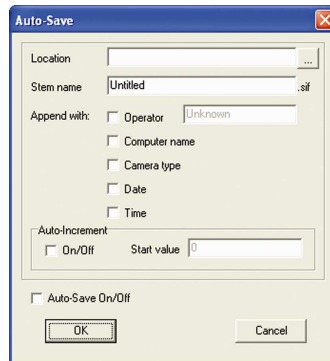

Tick the **Auto-Save On/Off** box. If selected, acquisitions will be saved automatically when each one is completed. Each subsequent auto-saved file will over-write the previously auto-saved one.

There is also an **Auto-Increment On/Off** tick box. This allows a number to also be appended to the main Stem Name. This number is automatically incremented each time a file is saved. This time the auto-saved files will not overwrite any previous auto-saved files. In the Auto-Save dialog box, a **Stem Name** may be entered. This is the main root of the name that the acquisition is to be saved as.

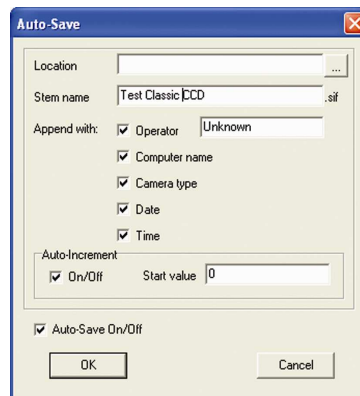

The Stem Name can be appended with a number of details:

- **Operator name (supplied by user)**
- **Computer name**
- **Camera type**
- **Date**
- **Time**

Any combination of these may be selected by activating the relevant tick box.

NOTE: This function will only Auto-Save Single Scan, Kinetic Series, Fast Kinetics or Accumulated images, not data acquired in Video mode.

4.4 - SPOOLING

The Andor Solis software allows you to spool acquisition data direct to the hard disk of your PC. This is particularly useful when acquiring a series of many images. The amount of data generated by a Kinetic Series of 1000 acquisitions, for example, is huge and more than most PC RAM can handle.

To enable the spooling function on your software, select **Kinetic Series** mode, select a figure greater than 1 in the **Number in Kinetic Series** field, then tick **Enable** in the **Spool** field., e.g.:

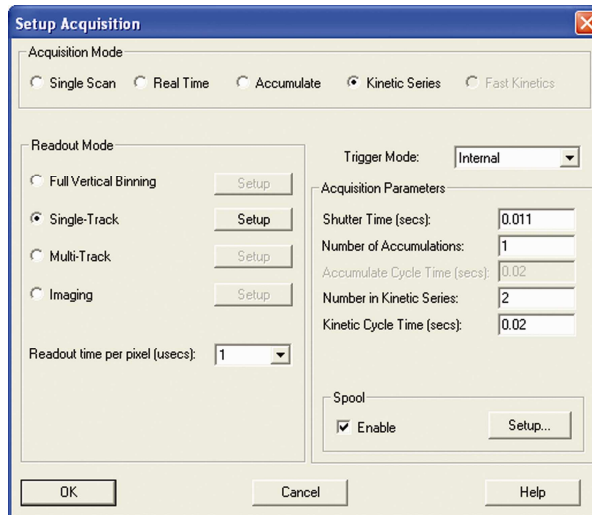

With the spooling function enabled, data is written directly to the hard disk of you PC, as it is being acquired.

You must also enter a stem name, and also select a location for the for this spooled data file, e.g.:

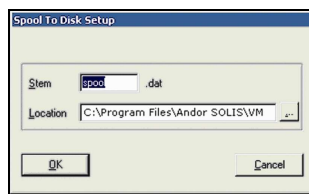

NOTE: Spooling large amounts of data straight to hard disk for later retrieval requires a hard disk of sufficient read-write speed. Andor recommends only very high-speed hard disk drives be used for this type of operation.

SECTION 5 - ACQUIRING DATA

5.1 - INITIAL ACQUISITION

To start an initial data acquisition you can either:

- Click the  button on the **Main Window**
- Press **F5** on the keyboard
- Select the **Take Signal** option from the **Acquisition** drop-down menu:

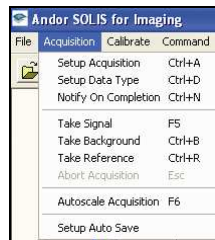

The **Data Window** opens, (labeled **#0 Acquisition**) and displays the acquired data, according to the parameters selected on the Setup Acquisition Dialog box. e.g.:

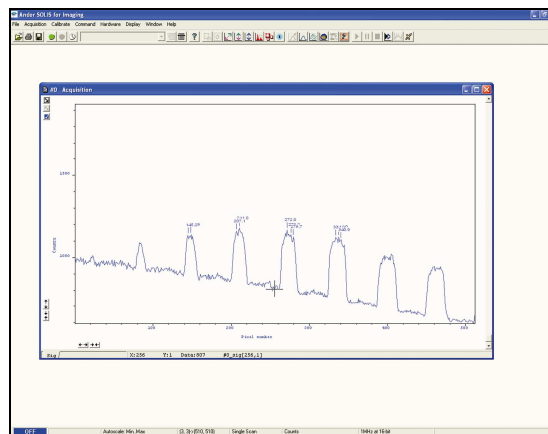

#n uniquely identifies the data set while the data set is being displayed and is temporary. It ceases to be associated with the data set once you close all data windows bearing the same #n. It is often referred to as an Acquisition Window. **NOTE: Each data window has the same name and #n (which identify the data set), but a unique number, following the data set name, to identify the window itself. Data can be modified only in a data window labeled with the name and the #n of the data set to which the data belong. If you modify a data set and attempt to close the data window, you will be prompted to save the data set to file.** If you have selected **Accumulate** or **Kinetic** as the **Acquisition** mode, new data will continue to be acquired and displayed until you carry out one of the following actions:

- Select **Abort Acquisition** from the Acquisition drop-down menu.
- Click the  button
- Press the **<ESC>** key

This stops any data capture process that may be under way. Information on how to capture and view more detailed data is contained in the pages that follow.

When the Setup Data Type option of the Acquisition drop-down menu is selected, the Data Type dialog box opens:

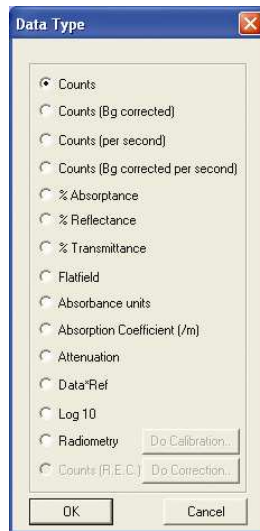

From the dialog box you can select the type of information (e.g. %Absorptance) that you want the system to compute and display whenever you perform Take Signal. The acquired data are presented under the Sig tab of an Acquired Data Window. The data type you select will determine whether you need to take a background and/or a reference scan using the Take Background and/or Take Reference options. These options are described in more detail later in this section. The descriptions of the data types are shown in **Table 5** which follows on the next two pages.

Table 5: Data Types

OPTION	FUNCTION
Counts	Counts represents raw, digitized data (i.e. no calculations have been performed on the data) from the CCD detector's analog to digital (A/D) converter. Please refer to the detailed performance sheet accompanying your particular CCD detector for the number of electrons that correspond to 1 count.
Counts (Bg corrected)	Counts (Background Corrected) is digitized Data from the CCD detector's analog to digital (A/D) converter, where Background (or dark signal) has been removed. Counts (Bg. Corrected) = Signal - Backgrounds
Counts (per second)	Counts divided by Exposure Time.
Count (Bg corrected per second)	Counts (Bg corrected) divided by Exposure Time.
%Absorptance	Represents the light absorbed by an object. If Reference is the background corrected incident intensity, and Signal - Background the transmitted intensity (i.e. the intensity of light which has passed through the material being examined), then: % Absorptance = 100 x (1 - (Signal - Background) / Reference)
%Reflectance	Represents the light reflected by an object. If Reference is the background corrected incident intensity, and Signal - Background the reflected intensity (i.e. the intensity of light which has been reflected from the material being examined), then: % Reflectance = 100 x (Signal - Background) / Reference
%Transmittance	Represents the light transmitted by an object. If Reference is the background corrected incident intensity, and Signal - Background the transmitted intensity (i.e. the intensity of light which has been transmitted through the material being examined), then: % Transmittance = 100 x (Signal - Background) / Reference
Flatfield	Flatfield is used to remove any pixel-to-pixel variations that are inherent in the CCD sensor. If Reference is the background corrected incident intensity, the Signal is divided by the Reference so: Flatfield = M x Signal / Reference where M is the Mean of Reference .
Absorbance units	A measure of light absorbed by an object (i.e. they represent the object's Optical Density (OD)). If Reference is the background corrected incident intensity, and Signal - Background the transmitted intensity (i.e. the intensity of light which has passed through the material being examined), then Transmission = (Signal - Background) / Reference. Absorbance Units are defined as Log ₁₀ (1 / Transmission), therefore: Absorbance Units = Log₁₀ (Reference / (Signal - Background)).
Absorption Coefficient (/m)	Indicates the internal absorptance of a material per unit distance (m). It is calculated as -log _e t, where t is the unit transmission of the material and log _e is the natural logarithm. If Reference is the background corrected incident intensity, and Signal - Background the transmitted intensity (i.e. the intensity of light which has passed through the material being examined), then: Transmission = (Signal - Background) / Reference and Absorption Coefficient = -log_e ((Signal - Background) / Reference)

Table 5: Data Types (continued)

OPTION	FUNCTION
Attenuation	A measurement, in decibels, of light absorbed due to transmission through a material - decibels are often used to indicate light loss in fiber optic cables, for instance. If Reference is the background corrected incident intensity, and Signal - Background the transmitted intensity (i.e. the intensity of light which has passed through the material being examined), then: Attenuation = 10 x log₁₀ ((Signal - Background) / Reference)
Data*Ref	Allows you to 'custom modify' the background corrected signal: Data x Ref = (Signal - Background) x Reference Store Value See the Andor Basic Programming Manual for similar operations
Log 10	Calculates the logarithm to the base 10 of the background corrected signal counts. Log Base 10 = log₁₀ (Signal - Background)
Radiometry	Allows you to calculate values for radiance or irradiance. The system requires that you supply calibration details. This option must be ordered separately.
Counts (R.E.C.)	Radiometric calculation for Mechelle spectrograph. Supplied with Mechelle systems.

As an example, the system will compute %Absorptance as:

$$100 \times (1 - (\text{Signal} - \text{Background}) / \text{Reference})$$

The illustration below shows typical use of Background, Reference and Signal for computations such as %Absorptance or %Transmittance.

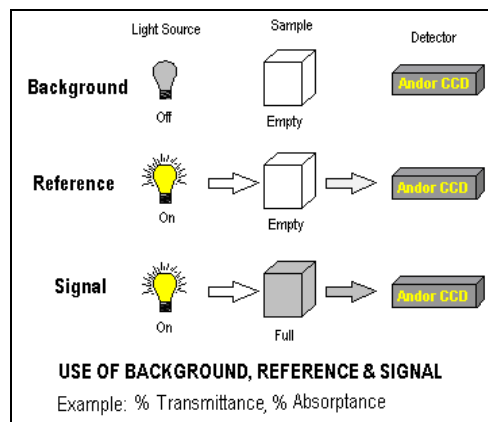

The default data type (used when you capture data and have not explicitly made a selection from the Data Type dialog box) is Counts.

- If you select background corrected counts as your data type, i.e. **Counts (Bg Corrected)**, you will have to perform Take Background before you perform Take Signal.
- If you select any data type other than **Counts** or **Counts (Bg Corrected)** you will have to perform Take Background and Take Reference (in that order) before performing Take Signal.

The calculations for the various data types assume the following definitions:

- **Signal:** data in uncorrected Counts, acquired via Take Signal.
 - **Background:** data in uncorrected Counts, acquired in darkness, via Take Background.
 - **Reference:** background corrected data, acquired (usually for the purpose of computing a material's reflection, transmission or absorption characteristics) via Take Reference. Reference data are normally acquired from the light source, without the light having been reflected from or having passed through the material being studied.
- If you require raw or background corrected data pertaining to the light source itself, Signal will be data acquired directly from the source.
 - If you intend to compute the reflection, transmission or absorption characteristics of a material, Signal will be data acquired from light that has passed through or has been reflected from the material being studied.

NOTES:

1. 'Signal', as used in the definitions of the calculations, refers to 'Raw' data from the CCD and should not be confused with the possibly 'Processed' data to be found under the Sig tab of the data window.
2. Functionality for displaying and manipulating data is only available if a data file has been opened, if data have been newly acquired, or if you are using the Andor Basic programming language to create a new window in which to display data. In each case data are displayed in a data window.

5.3 - ACQUISITION TYPES

From the Acquisition drop-down menu on the Main Window, you can make the following data acquisition selections:

- Take Signal
- Take Background
- Take Reference

Provided you do not change the acquisition parameters, the scans you take for background and reference are automatically used for subsequent data acquisitions whenever you perform Take Signal.

5.3.1 - Take Signal with Autoscale Acquisition Off

Autoscale Acquisition can be selected from the Acquisition drop-down menu as shown (or press F6 on the keyboard):



With Autoscale Acquisition deselected, the display will remain the same size regardless of brightness settings, etc. When selected off, the  button appears (click this button to switch back on).

5.3.2 - Take Signal with Autoscale Acquisition On

With Autoscale Acquisition selected, the system will configure the Acquisition Window (if necessary adjusting its scales in real time) so that all data values are displayed as they are acquired.

The  button appears when selected on. The data are displayed in accordance with the selection made on the Rescale Data Mode on the Display Menu:

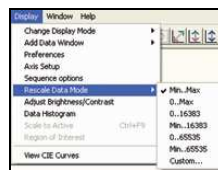

You can choose to display values between the following parameters:

Minimum & maximum (Min..Max)

- Zero & maximum (0..Max)
- Zero & 16383 (0..16383)
- Minimum & 16383 (Min..16383)
- Zero & 65535 (0..65535)
- Minimum & 65535 (Min..65535)
- Custom setting as required.

For further information on **Rescale**, please refer to **page 100**.

5.3.3 - Take Background

The Take Background option of the Acquisition drop-down menu instructs the system to acquire raw background data. These are as counts of the Acquisition Window. No calculations are performed on these data. The data type you select via Setup Data Type on the Acquisition Menu may require you to perform Take Background before you perform Take Signal.

NOTE: You do not necessarily have to take background data prior to each acquisition of signal data. If the data acquisition parameters remain unchanged since you last performed take background, then no new background data is required.

5.3.4 - Take Reference

The Take Reference option of the Acquisition drop-down menu instructs the system to acquire background corrected data that will be used subsequently in calculations that require a reference value. Before executing this function you must therefore perform a Take Background.

The data you acquire using Take Reference are displayed as counts minus background under the **Ref** tab of the Acquisition Window.

NOTE: The data type you select via Setup Data Type on the acquisition menu may require you to perform take reference before you perform take signal.

5.3.4.1 - Acquisition Errors

If you perform an operation “out of sequence”, the system will prompt you by launching an Acquisition Error message, e.g.

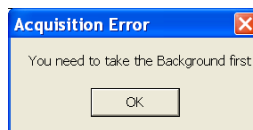

5.4 - ORGANIZING WINDOWS

The Window menu offers a number of options which help you manage the data windows or icons that you have created while working with the system. Table 6 below explains the available options.

Table 6: Window options

OPTION	DESCRIPTION
CASCADE	Arranges any open Data Windows or Program Editor Windows) into a stack which runs diagonally across the Main Window and allows you to see the title bars of each of the windows in the stack.
TILE HORIZONTAL	Arranges and resizes any open Data Windows or Program Editor Windows so that all run the full width of, and are fully visible within, the Main Window. Any icons that have been created within the system will be arranged into a row starting at the bottom left of the screen.
TILE VERTICAL	Arranges and resizes any open Data Windows or Program Editor Windows so that all run the full height of, and are fully visible within, the Main Window. Any icons that have been created within the system will be arranged into a row starting at the bottom left of the screen.
ARRANGE ICONS	Places in a row (starting at the bottom left of the screen) any icons that have been created within the system.
CLOSE ALL	Removes all windows and icons from the Main Window. You will be prompted to save any unsaved data.
COPY TO CLIPBOARD	For use only with Data Windows. Copies the contents of the active Data Window into the Windows clipboard. Data which have been copied to the clipboard can be pasted into other Windows applications, where it will be treated as a picture or 'bitmap'.

In addition to the window-handling options described, the Window Menu displays a list below the Copy to Clipboard option of any open Data Windows or Program Editor Windows or are currently iconized within the system. When the name of the window or icon in the list is selected, the corresponding window or will be brought to the front of the Main Window (if the Data Window or Program Editor Window was iconized it will now be opened as well).

5.5 - ACQUISITION MODES & TIMINGS

An acquisition is taken to be the complete data capture process that is executed whenever you select Take Signal, Take Background, or Take Reference from the Acquisition Menu or whenever you click the Take Signal button.

By contrast, a scan (an 'Acquired Scan' in the definitions that follow) is 1x readout of data from the CCD-chip. Several scans may be involved in a complete data acquisition.

The minimum time required for an acquisition is dependent on a number of factors, including the Exposure Time (the time in seconds during which the CCD collects light prior to readout.) and the Triggering mode. Triggering modes are described in more detail later in this section.

5.5.1 - Single Scan

Single scan is the simplest acquisition mode, in which the system performs one scan of the CCD.

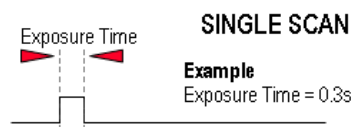

NOTE: Should you attempt to enter too low a value, the system will default to a minimum exposure time.

5.5.2 - Real Time

If you click the  button, the system repeatedly performs a single scan and updates the data display.

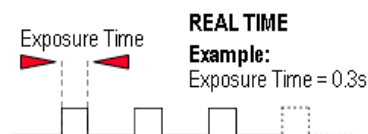

New data will continue to be acquired and displayed until you either :

- Select **Abort Acquisition** from the **Acquisition** menu
- Click the  button
- Press the **<ESC>** key

This stops any data capture process that may be under way.

NOTE: This is a useful mode if, for example, you want to capture data as you optimize a hardware set-up.

5.5.3 - Accumulate

Accumulate mode allows you to add together in computer memory the data from a number of scans to create an 'Accumulated Scan' i.e.

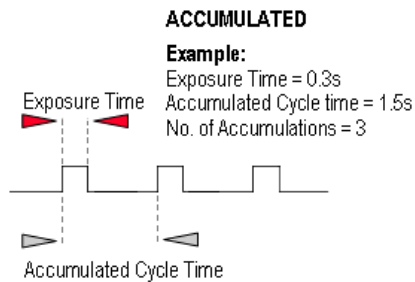

You can select the following parameters in the Setup Acquisition dialog box:

- **Exposure Time**
- **Accumulated Cycle Time:** the period in seconds between each scan. This parameter is only available if you have selected **Internal** triggering. Please refer to **Triggering Modes** on **pages 60 - 61** for more information.
- **No. of Accumulations:** the number of scans you want to add together.

NOTE: This mode is used to improve the **Signal to Noise ratio**.

5.5.4 - Kinetic Series & Accumulated Kinetic Series

In the Setup Acquisition dialog box you can key in the following parameters, which relate both to the kinetic series itself and where marked *, to the accumulation process:

- **Exposure Time**
- ***Accumulate Cycle Time:** the period in seconds between the individual scans (see Number of Accumulations below) that are accumulated in computer memory to create each member of your kinetic series - each member of the series is an 'accumulated scan'. This parameter is only available if you have selected Internal Triggering.
- ***Number of Accumulations:** the number of scans you want to add together to create each member of your kinetic series. The default value of 1 means that each member of the kinetic series will consist of a single scan.
- **Kinetic Cycle Time:** the interval at which each scan (or set of accumulated scans) begins. This parameter is only available if you have selected Internal Triggering.
- **Number in Kinetic Series:** the number of scans or accumulated scans you require in your series.

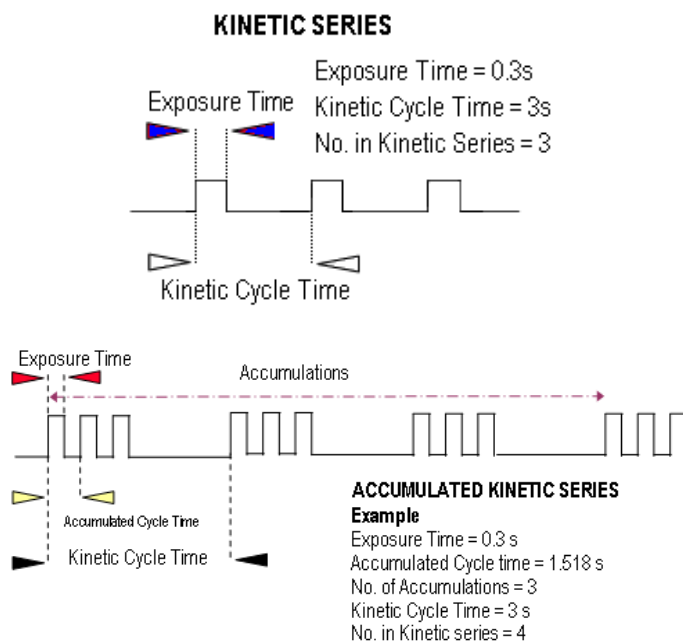

NOTE: This mode is particularly well suited to recording the temporal evolution of a process.

5.6 - TRIGGERING MODES

The required **Trigger Mode** is selected from a drop-down list on the right-hand side of the **Setup Acquisition** dialog box, e.g.:

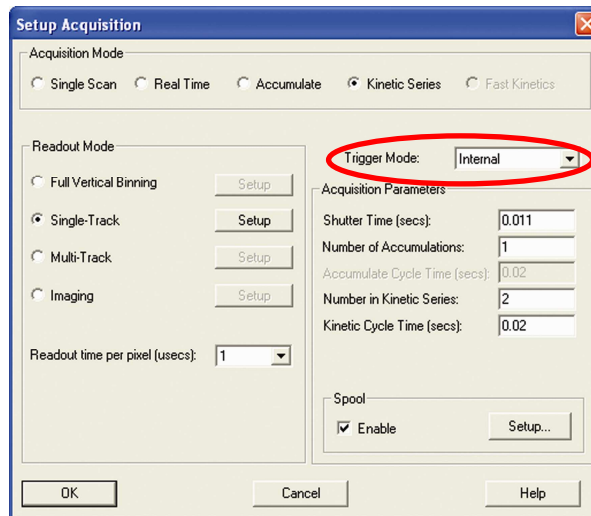

The selections available are as follows:

- **Internal**
- **External**
- **External Start**

5.6.1 - Internal

In Internal mode, once you issue a data acquisition command, the system determines when data acquisition begins. You can use Internal mode when you are able to send a trigger signal or “Fire Pulse” to a short-duration, pulsed source (e.g. a laser). In this case starting data acquisition also signals the pulsed source to fire.

The Fire Pulse is fed from pin 11 of the Auxiliary Connector on the Controller Card via the Fire socket of the IO160 Multi I/O Box or the IO 165 Advanced Multi I/O Box to the pulsed source. For details of the IO160 and IO165, please refer to **pages 22 - 24**.

Internal Trigger Mode is also used with “**Continuous Wave**” (**CW**) sources (an ordinary room light, for instance), where incoming data, for the purposes of your observation, are steady and unbroken. This means that acquisitions can be taken at will.

5.6.2 - External

In External mode, once you issue a data acquisition command, data will not be acquired until your system has received an External Trigger signal generated by an external device (e.g. a laser). The External Triggering signal is fed via the Ext Trig socket of the IO160 Multi I/O Box or the IO 165 Advanced Multi I/O Box to pin 13 of the Auxiliary Connector on the Controller Card. **NOTE: If you have a shutter connected and are using external triggering, you must ensure that the shutter is open before the optical signal you want to measure occurs.**

5.6.3 - External Start

With External Start triggering, once you issue a data acquisition command, data will not be acquired until your system has received an external trigger signal generated by an external device. The system will then continue to acquire data based on user options set within the Acquisition Dialog. This means that an External Start Trigger could be used to commence acquisition of a Kinetic series, but with the parameters of that series being controlled by internal software options.

The External Start signal is fed via the Ext Trig socket of the IO160 Multi I/O Box or the IO 165 Advanced Multi I/O Box to pin 13 of the Auxiliary Connector on the Controller Card.

NOTE: If you have shutters connected, and are using an external trigger, you must ensure that the shutter is open before the optical signal you want to measure occurs.

5.6.4 - Triggering type selection

The following questions will help you decide whether you should use Internal or External triggering:

1. Is the optical signal CW? If yes, select Internal Trigger Mode and make your acquisitions. If no, go to 2.
2. Are you using a pulsed source (e.g. a laser or a lamp) that can accept a trigger?
 - If yes, select Internal Trigger mode. Connect the Fire output of the IO160 or IO165 to the trigger input of the pulsed source. Set the Exposure Time or Shutter Time to encompass all of the optical pulse. Make your acquisitions.
 - If no, go to 3.
3. Are you using a pulsed source (e.g. a laser or a lamp) that can send a trigger? If yes, select External Trigger Mode. Connect the trigger output of the pulsed source to the Ext Trig input of the IO160 or IO165. Set the Exposure Time or Shutter Time to encompass all of the optical pulse. Make your acquisitions.

5.7 - READOUT MODES

The Readout Modes available from the Setup Acquisition dialog box let you use the CCD chip at the heart of the detector to collect/readout data. The options available are as follows:

- **FVB (Full Vertical Binning)**
- **Single-Track**
- **Multi-Track**
- **Imaging**

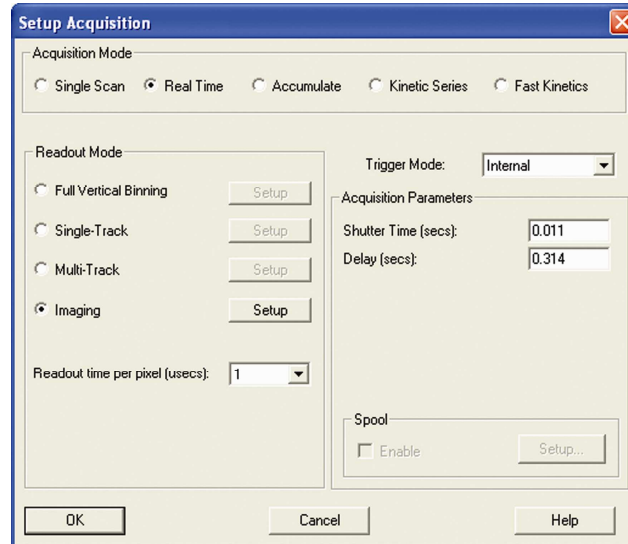

The Binning patterns used in each readout mode are as follows:

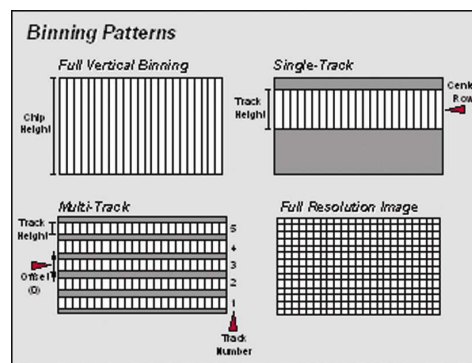

Binning is a process that allows charge from two or more pixels to be combined on the CCD-chip prior to readout. For a full explanation of binning please refer to pages 152 - 154.

5.7.1 - Full Vertical Binning

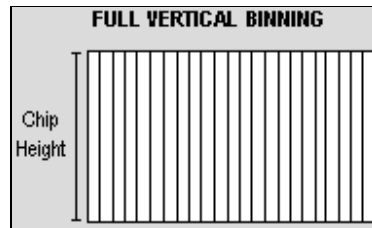

Full Vertical Binning (FVB) allows you to use the CCD-sensor as a **Linear Image Sensor (LIS)**, i.e. a photodiode array). The charge from each column of pixels (each column being chip height) is combined on the chip, or 'binned', to give a single value per column.

Click the Setup button beside Full Vertical Binning in the Readout Mode field of the Setup Acquisition dialog box as shown on the previous page. The Full Vertical Binning dialog box will appear in order to define Horizontal Full Vertical Binning, e.g.:



As a default, the horizontal binning is set to one. This means that there will be 1024 pixels along the shift register assuming you are using a 3011 sensor. If the number is changed to two, say, then every second pixel in the shift register will be combined with the previous one to form 512 pixels with twice the effective pixel width for more information, please refer to **Horizontal Binning (Creating Superpixels)** on **page 154**.

For the **Flip Data Horizontally** function, please refer to **page 69**.

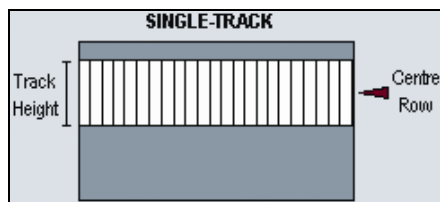

Single-Track mode differs from Full Vertical Binning, previously, in that you can now specify the height (in pixels) and vertical position on the CCD of a track from which to bin charge. The aim is to define a track corresponding to the position of your spectrum.

NOTE: Single-Track frame readout mode is particularly well suited to the long exposures needed to capture weak spectra (e.g. in Raman spectroscopy or measurements of weak fluorescence), since the data acquisition excludes dark signal from pixels outside the track. A Shutter may be required to prevent light (which would otherwise fall on the CCD-sensor outside the track) from corrupting data during readout.

Click the Setup button beside Single-Track in the Readout Mode field of the Setup Acquisition dialog box. The Single-Track dialog box will then appear e.g.:

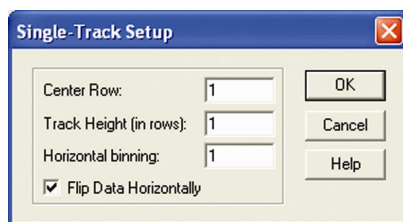

You can then enter the following parameters:

- **Center Row Number:** determines the vertical position of the track. Enter a value between 1 and 256 for a 30-11 CCD-sensor. In practice the value will fall in the 'mid-range', assuming that the spectrum is falling roughly across the middle of the CCD
- **Track Height (in rows):** enter a value corresponding to the height of spectrum under analysis. **NOTE: As a rough guide, in a non-magnifying spectrograph, 40 rows on a 30-11 CCD-sensor correspond to a slit height on the spectrograph of 1 mm.**
- **Horizontal Binning:** please refer to [page 154](#)
- **Flip Data Horizontally :** please refer to [page 69](#)

5.7.3 - Multi-Track (Standard)

Multi-Track mode allows you to create one or more tracks (each of which behaves as in Single-Track previously). This is a useful mode when using fiber-optics.

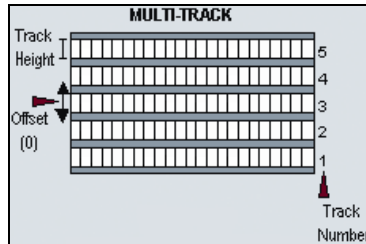

Click the Setup button beside Multi-Track in the Readout Mode field of the Setup Acquisition dialog box. The Single-Track dialog box will then appear e.g.:

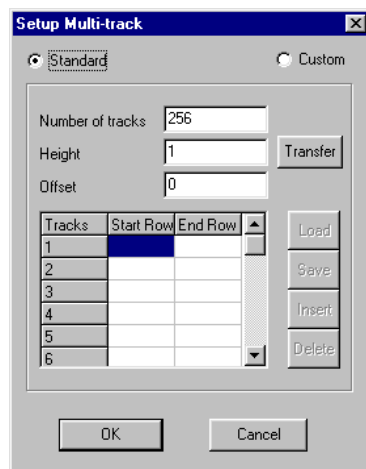

The following information can then be entered:

- **Number of Tracks:** this figure corresponds to the number of spectra.
- **Height (in rows):** use vendor details of the imaging spectrograph’s magnification and the fiber diameter to calculate this figure
- **Offset (no. of rows):** the distance by which the spectra are ‘off-center’ on the vertical axis. Enter either a **+ve** or **-ve** number (of rows) to respectively raise or lower the entire pattern of tracks created on the CCD

5.7.4 - Custom Multi-Track

With the standard Multi-track setup, you are limited to tracks of the same height and spacing. However, the Custom Multi-track table enables you to design a multi-track setup with varying track heights and spacing to suit any individual arrangement.

- When the Multi-Track parameters have been entered, they can be transferred into the Custom table by selecting the Transfer button. The Custom radio button will be automatically selected and individual track information will appear in the table as is shown in the example (**figure 9** below). The start and end row of each specified track is listed.
- The specified Multi-Track setup in the table can be saved as an .MTR file by clicking the Save button on the Setup Multi-track dialog box.
- Any saved multi-track configurations can be loaded at a future date by clicking the Load button on the Setup Multi-track dialog box.

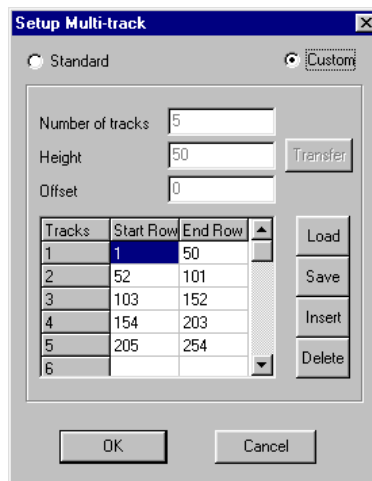

Figure 9: Setup Multi-track dialog box (Custom setting)

In order to modify a particular Multi-track setup, you can use the functions **Insert** and **Delete** in the Setup Multi-track dialog box.

Tracks	Start Row	End Row		Load
1	1	50		
2	52	101		Save
3	103	140		Insert
4				Delete
5	154	203		
6	205	254		

- Use Insert to put a blank row (track 4 in the example above) into the table where custom data can be entered to describe the dimensions of another track. Click on the box at the start of the row beneath the position where the inserted row is to go and press the Insert button.

NOTE: In order to enter a row into the table, there must be a separation of greater than two CCD rows, between the end of the previous track and the start of the next track.

Correspondingly, if you try to enter a figure that does not have this separation, an error message will appear stating that the tracks are too close and you will have to enter a more suitable value to continue, e.g.:

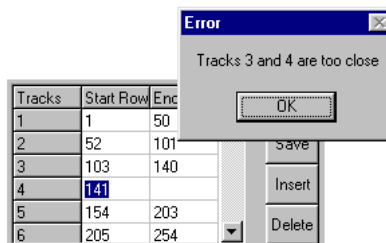

In the case above, the start row of track 4 is too close to the end row of track 3. An error message will also appear if data has not been input onto a blank row. You will not be able to continue until all the relevant data has been entered.

- Use Delete to remove rows from the custom Multi-track table by selecting the appropriate row and clicking the Delete button.

NOTE: Multiple tracks will allow you to simultaneously analyze a number of spectra, delivered typically via a fiber bundle to ensure appropriate spacing of the tracks you define on the CCD-sensor. An imaging spectrograph is, however, required to resolve the individual spectra, and unless you are acquiring data from a pulsed source, you will need to use a shutter to avoid streaking the spectra during the binning process. The Multi-Track image may be viewed in Grayscale or False Color, or it may be displayed as 2D or 3D traces (please refer to Section 6 - Displaying Data).

Multi-track mode can be used for a range of spectrographs and fiber bundles. Remember that acquiring data from tracks, rather than from the entire CCD-sensor, makes for faster binning.

Before using Multi-track mode with fiber bundles it is often useful to acquire a Full Resolution Image of the output of the spectrograph. Having observed the vertical position and spacing of the individual spectra, you can vary Track Height and Offset accordingly.

NOTE: Imaging spectrographs vertically invert input light (i.e. light from the top fiber will fall on the bottom track on the CCD-sensor).

5.7.5 - Image

By default, Image readout frame supplies you with a count from each pixel on the CCD, in effect allowing you to take an image of the light pattern falling on the pixel matrix of the CCD. This default is referred to as a Full Resolution Image. The image may be viewed in grayscale or false color, or it may be displayed as 2D or 3D traces. To select, tick the Imaging button in the Readout Mode field of the Setup Acquisition dialog box, then click on the Setup button. The Setup Image dialog box will appear, e.g.:

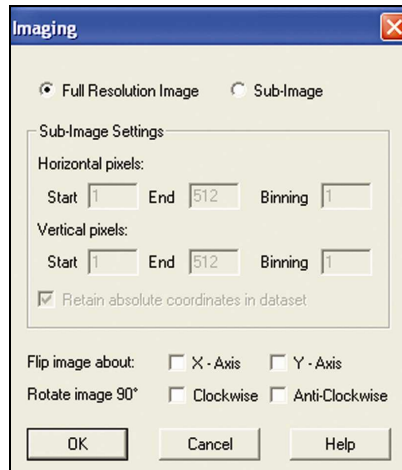

If you select Sub-Image, the text boxes in the Sub-Image Settings field become active, e.g.:

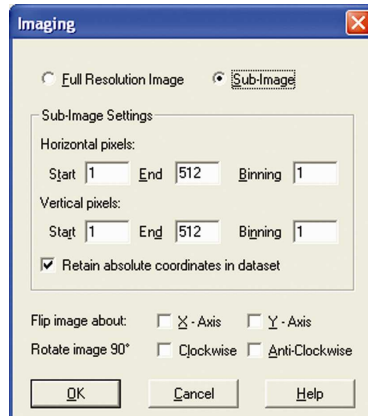

A sub-image of the CCD from which to read data can then be defined. Simply indicate which pixel numbers the sub-area begins and ends with on the horizontal and vertical axes. Please also refer to the next page for further information on defining Superpixels.

In addition, the tick boxes on the bottom become active as shown above. These allow an image to be rotated Clockwise (or Anti-Clockwise) by 90°, or to flip an image around the X and Y axes. This is particularly useful if the CCD-sensor has a readout register along its short, vertical edge as without rotation, images would by default appear sideways on screen.

5.7.7 - Superpixels

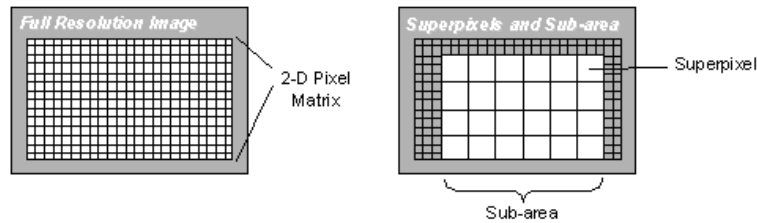

NOTE: ONLY THE SUB-AREA WILL BE DISPLAYED, NOT THE AREA AROUND IT.

Data can be readout from a selected area (a sub-area or sub-image) of the CCD and/or to create superpixels (superpixels consist of two or more individual pixels that are binned and read out as one large pixel so the CCD, or your selected sub-area, becomes a matrix of superpixels.)

Indicate the dimensions of the superpixels (as a number of pixels vertically and horizontally) in the text boxes on the Imaging Dialog Box as shown on the previous page. For example, if you enter **4** in the Binning box of the Horizontal binning field and **4** in the Binning box of the Vertical binning field, the CCD-sensor is notionally divided into a matrix of superpixels which each measure 4 x 4 pixels and provide a signal for readout.

By a process of binning charge vertically into the shift register from several rows at a time (4 rows in the above example, representing the height of your superpixels), and then binning charge horizontally from several columns of the shift register at a time (4 columns in the example, representing the width of the superpixels), the system is effectively reading out charge from a matrix of superpixels which each measure 4 x 4.

The result is a more coarsely defined image, but faster processing speed, lower storage requirements, and potentially a better signal to noise ratio (since for each element or superpixel in the resultant image, the combined charge from several pixels is being binned and read out, rather than the possibly weak charge from an individual pixel).

5.7.8 - Readout Time

From a drop-down list box in the Readout Mode field of the Setup Acquisition dialog box you can select **Readout time per pixel (usec)**:



The following options are available (in μsecs):

- 1 *
- 2 *
- 16
- 32 2xGain

NOTE: *The 1 and 2 μsec read-outs are only available if your PCI controller card has been equipped with the optional high-speed analog to digital conversion hardware. The 2 μsec option is intended to accommodate computers that are too slow to use the 1 μsec option. In general, a lower readout time per pixel, while permitting faster acquisitions, results in increased noise in the data.

5.7.9 - Exposure Time v Shutter Time

If you select a readout mode other than **Full Vertical Binning** (see page 63), the Exposure Time caption changes to Shutter. The caption changes to reflect the condition that, with the exception of Full Vertical Binning, no light must fall on the CCD during the readout process: otherwise the image will be smeared. If your binning pattern is Full Vertical Binning, the shutter, if connected, will remain in the open position at all times, except when background data are being acquired. If you want the equivalent of Full Vertical Binning but with shutter operations, choose Single Track, with the Track Height set to maximum.

The value entered in the Shutter Time text box determines the length of time during which the Shutter output signal will be in the open state. If you are using Internal Trigger Mode, the rising edge of the Fire output signal follows the start of the shutter open state after a delay, which you set and which should correspond to the time your shutter takes to open and to close (see **Time to Open or Close** on page 76). The system adds a similar delay to the end of the acquisition sequence.

This Time to open or close is sometimes referred to as the Transfer Time. The Transfer Time is added to the end of the acquisition sequence, since (unless you are using Full Vertical Binning) the shutter must be fully closed before readout of the CCD can start. Similarly, the Transfer Time is added to the start of the acquisition sequence since, if the full light signal from a pulsed source is to be captured, the shutter must be fully open before the pulsed light source is fired. Please refer to the **diagram on page 85**.

5.7.10 - Delay

If you have chosen **Real Time** as your acquisition mode, you may enter a Delay. The Delay (in seconds) is the time you require between the on-going scans. The system will default to a minimum delay should you attempt to enter too low a value: in Real Time acquisition mode the system will acquire data only as quickly as it can display the data. If you perform Take Background or Take Reference in Real Time acquisition mode, the system will perform one scan only, rather than repeatedly performing a scan at the delay indicated.

5.7.11 - Accumulate Cycle Time & No. of Accumulations

If you have selected Accumulate or Kinetic as the acquisition mode, with Internal triggering, you can also select the Accumulation Cycle Time and No. of Accumulations.

- The Accumulation Cycle Time is the period in seconds between each of a number of scans, whose data are to be added together in computer memory to form an Accumulated Scan.
- The Number of Accumulations indicates the number of scans you want to add together.

5.7.12 - Kinetic Series Length & Kinetic Cycle Time

When Kinetic is selected as the acquisition mode, with Internal triggering you can also select the following parameters:

- **Kinetic Series Length:** the number of scans you require in your series
- **Kinetic Cycle Length:** the interval (in seconds) at which each scan (or accumulated scan) in your series begins

5.8 - SHUTTER CONTROL

A shutter can be used to take a reference or background if Full Vertical Binning is selected. For either Multi-Track or Image mode, the shutter is required to avoid unnecessary signals/light falling on the CCD during the readout process; otherwise the image will be smeared. To open, select **Shutter Control** from the Hardware drop-down-menu:

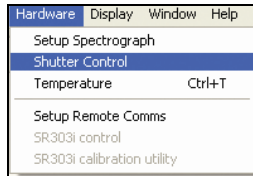

The **Shutter Control** dialog box then opens e.g.:

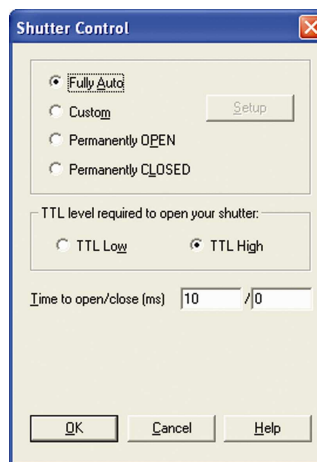

You can use this to indicate when and how a hardware shutter should be used. With a CCD, the shutter is used for background shuttering.

Certain settings (e.g. **Permanently OPEN & Permanently CLOSED**) take effect as soon as you close the Shutter Control dialog box. Other settings will be applied whenever you acquire data.

- **Fully Auto** is the simplest shutter mode, as it leaves all shuttering decisions to the system. When you perform Take Signal the shutter opens for the duration of the Exposure Time you have entered in the Setup Acquisition dialog box. **NOTE: This option will automatically provide suitable shuttering for the majority of data acquisitions. The shutter will be closed for background data acquisitions and will be opened for all other data acquisitions.**
- In **Permanently OPEN** mode, the shutter will be open before, during and after any data acquisition.
- **Permanently CLOSED** mode can be useful if you want to take a series of acquisitions in darkness and do not require the shutter to open between acquisitions. You might, for example, wish to capture a sequence of background values. The shutter remains closed before, during and after any data acquisition.
- The **TTL (Transistor-Transistor Logic)** buttons, **TTL Low & TTL High**, let you instruct the system as to how it should control the opening and closing of the shutter.
 - If you select **TTL Low**, the system will cause the output voltage from the CCD to go “**low**” to open the shutter.
 - If you select **TTL High**, the system will cause the output voltage from the CCD to go “**high**” to open the shutter.

The documentation supplied by the shutter manufacturer will show whether your shutter opens at a high or a low. The shutter pulse is fed from pin 12 of the Auxiliary Connector on the Controller Card (via the Shutter socket of the IO160 or IO165).

NOTE: The shutter pulse is not capable of driving a shutter. It is only a 5V pulse designed to trigger TTL & CMOS compatible shutter drivers. Also there is no shutter pulse during the Take Signal and Take Reference data acquisitions.

5.8.1 - Time to Open or Close

Shutters take a finite time to open or close and this is sometimes called the **Shutter Transfer Time (STT)**. The documentation supplied by the shutter manufacturer should indicate the STT you can expect from your particular shutter. In the case of a CCD detector, the STT gives enough time for the shutter to open before acquisition starts and enough time to close after acquisition finishes and before readout commences.

Let us look at the Transfer Time in the context of the Andor system. By default, the value you enter in the Exposure Time text box on the Setup Acquisition dialog box determines the length of time the shutter will be in the open state. However, to accommodate the Transfer Time, the rising edge of the shutter output is sent before the **FIRE** output signal by an amount equal to the STT. You should set this value to the Transfer Time of your shutter.

The system also automatically adds the Transfer Time to the end of the acquisition sequence, introducing an appropriate delay between the start of the shutter closed state and the commencement of the data being read out as shown in the following example diagram:

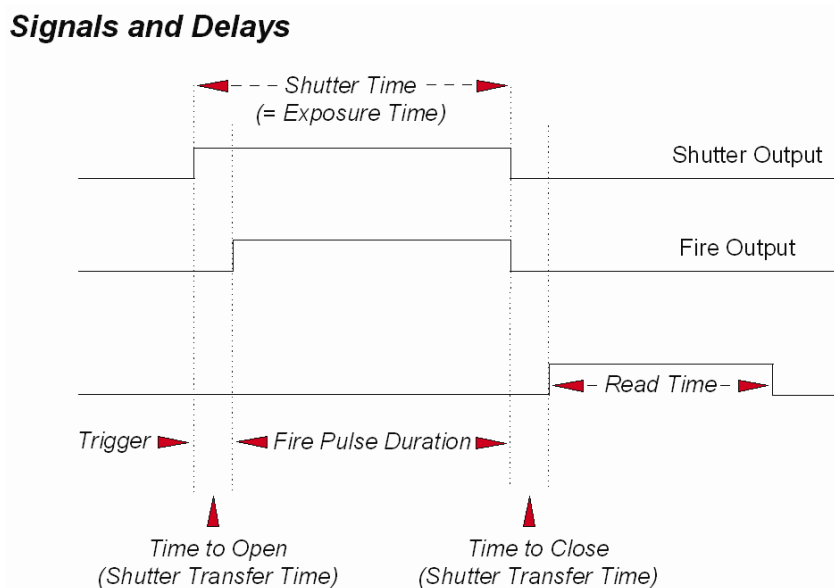

If you do not have a shutter connected, set the Time to open or close to 0. Setting the Time to open or close to any other value will insert extra delays into cycle time calculations.

5.8.2 - Shutter Custom Settings

When the **Custom** setting is selected on the Shutter Control dialog box, the Custom Settings dialog box opens, e.g.:

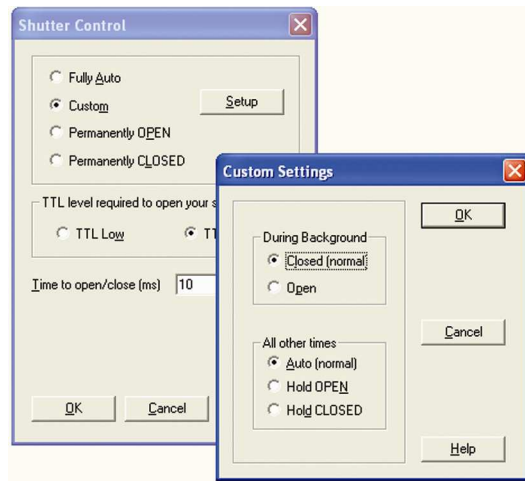

The Custom Settings Dialog Box is divided into two sections, which deal with shutter control during background data acquisitions, and at all other times. By “dividing” the shutter functionality in this way, the Custom Settings Dialog Box gives you a finer degree of control over shutter behavior than the Shutter Control Dialog Box. Selections may be made from each section of the Custom Settings Dialog Box by means of radio buttons.

5.8.2.1 - During Background

The two radio buttons, Closed (normal) and Open, allow you to choose the status of the shutter during background data acquisitions.

If Closed (normal) is selected, any shutter driven from the Shutter output will be closed as you perform Take Background (see page 55). Closed (normal) is default setting.

Select Open if you want the shutter to be open so that the Take Background function records genuine optical data.

NOTE: Usually a background scan is used to subtract the dark signal and the Fixed Pattern Noise (FPN) of the sensor. For this reason the background scan is usually performed in darkness. A shutter may be used to stop light entering the spectrograph or other imaging system. Strictly speaking though, the background acquisition may be regarded as comprising all light with the single exception of the source. Thus, where you are working with a pulsed or independently shuttered source, it may be appropriate to select the Open [During Background] setting on the Custom Settings dialog box.

5.8.2.2 - All other times

The three radio buttons, **Auto (normal)**, **Hold OPEN** and **Hold CLOSED**, determine the status of the shutter for all data acquisitions other than background data acquisitions. This functionality contrasts with the Fully Auto, Permanently OPEN, and Permanently CLOSED options on the Shutter Control Dialog Box, which apply to all data acquisitions.

NOTE: The combination of Closed [During Background] and Auto [All Other Times] in the Custom Settings dialog box corresponds to the Fully Auto option on the Shutter Control dialog box.

5.9 - COSMIC RAYS

Cosmic rays are very high energy particles, originating in outer space, that enter the Earth's atmosphere and produce a shower of further high energy particles. When one of these particles passes through the CCD it will produce between 0 and thousands of photoelectrons in a very small area (usually 1 to 4 pixels) and due to the low read noise of the CCD this will appear as a spike of up to several hundred counts.

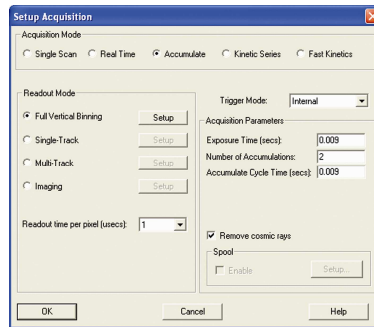

The **Remove cosmic rays** option is only available when **Accumulate** has been selected as the **Acquisition Mode**. When selected, each scan will be compared with the previous one, for the presence of unusual features. An example of a unusual feature is shown here:

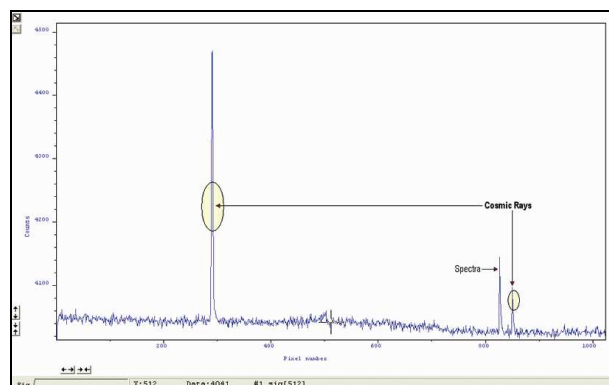

If one is found, its pixel value will be replaced with a scaled version of the corresponding scan, e.g.:

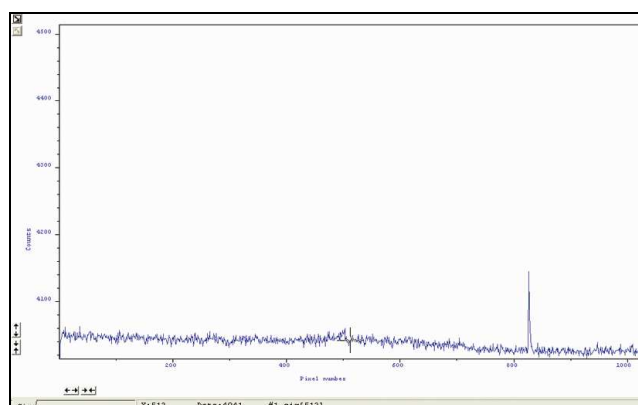

NOTE: This option is only available if there are 2 or more scans to compare. It takes twice as long to acquire one data set.

5.10 - FILE INFORMATION

Details of the Acquisition selection can be viewed by clicking the  button on the Main Window which opens the Information dialog box (you can enter your own notes in the Comments box), e.g.:

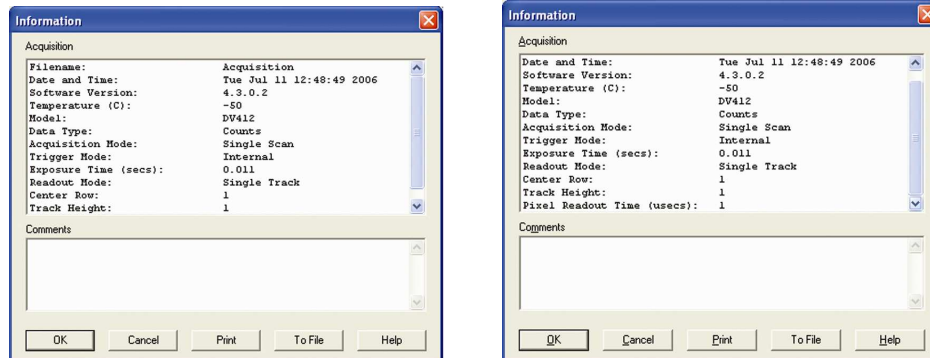

The table below details the type of information contained in the dialog box.

Table 7: File information types

Filename	The filename associated with the active Data Window. If the data has not yet been saved this will default to Acquisition
Date and time	The date & time at which the acquisition was made
Software Version	The version of Solis software being used
Temperature (C)	The temperature to which the detector had been cooled
Model	The model number of the detector
Data Type	Data Type: Counts, % Transmittance, etc.
Acquisition Mode	Single Scan, Real Time, Accumulate, Kinetic Series or Fast Kinetics
Trigger Mode	Internal, External or External Start
Exposure Time (secs)	“Fire” pulse length
Readout Mode	Full Vertical Binning, Single-Track, Multi-Track or Imaging
Center Row	The vertical position of the track (see page 65)
Track Height	The height of spectrum under analysis (see page 65)
Pixel Readout time (usecs)	Value selected from the dropdown menu

SECTION 6 - DISPLAYING DATA

6.1 - DISPLAY MODES

Once the parameters for the data acquisition have been set and data has been successfully acquired, there are 3 main options available to display the data, which are as follows:

- **2D**
- **3D**
- **Image**

The Display drop-down menu also offers various options to change the various formats of the display as shown below:

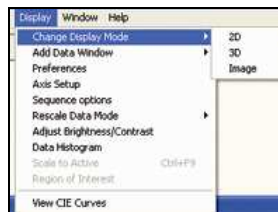

Some of the options are also available via icons on the Main Window and these are shown later in this section.

NOTE: Scale to Active is only available if you are in 2D display mode and have chosen to overlay a number of traces. Overlay is explained in more detail on pages 93 - 95.

6.2 - AXIS DEFINITIONS

In descriptions of the data window and in on-screen captions the terms x-axis, y-axis and data-axis are used as follows:-

- The x- and y-axes define a pixel's position on the two-dimensional CCD-chip, e.g.:

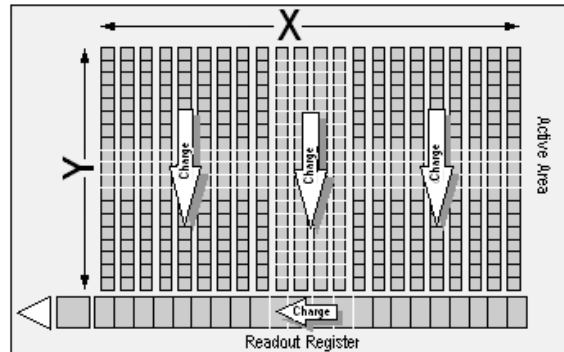

- The x-axis (or horizontal display axis) is parallel to the readout register and may be calibrated in pixels or in a unit of your choice.
- The y-axis (or vertical display axis) is perpendicular to the readout register and may be calibrated in pixels or in a unit of your choice.

The data-axis is calibrated in the unit of your choice and has data values plotted against it. In 2D and 3D display modes, the data-axis is the vertical display axis. In Image Display Mode, data are represented by a color or a grayscale tone. For more information on **Calibration**, please refer to **Section 8**.

In all display modes, x- and data-values are displayed on the status bar along the bottom edge of the Data Window.

When data has been acquired in a mode other than Full Vertical Binning, y-values are also displayed in the status bar.

6.3 - DISPLAY PREFERENCES

The way data is displayed in the various modes can also be changed. From the Display menu drop-down options, select the Preferences option as shown:

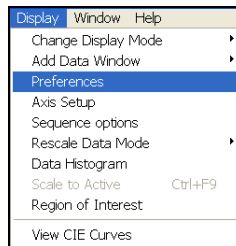

The Display Preferences dialog box appears as shown:

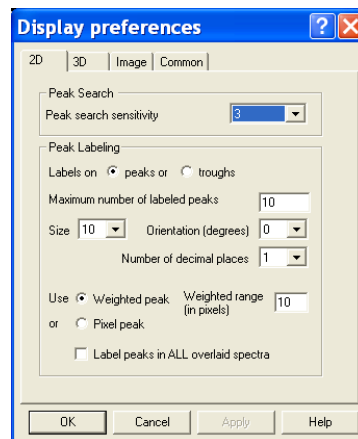

By clicking on the appropriate tab, you can select or deselect certain features associated with the data window for the mode of your choice.

6.3.1 - 2D Display Preferences

The following options are available to view peaks when in 2D Display mode:

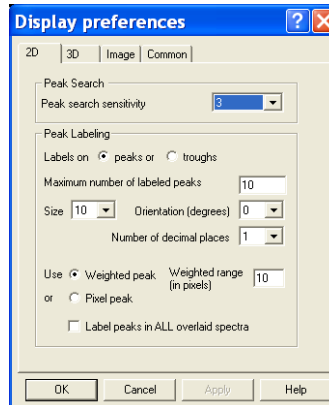

The display is similar to the following:

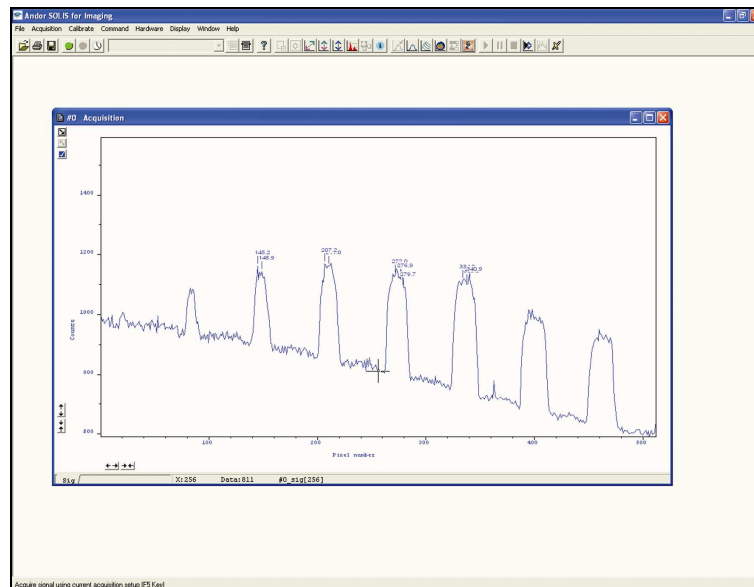

6.3.2 - Peak Search**6.3.2.1 - Peak Search Sensitivity**

The Peak Search Sensitivity option Determines the manner in which the cursor moves between peaks/troughs when you key in **Ctrl + Right Arrow** or **Ctrl + Left Arrow**.

- A low sensitivity (e.g. 1) means the system will find the most prominent peaks or troughs
- A high sensitivity (e.g. 5) means less obvious peaks or troughs will be found

NOTE: This parameter relates only to Peak Search, not to Peak Labeling.

6.3.3 - Peak Labeling**6.3.3.1 - Labels on Peaks or Troughs**

Lets you choose whether to mark the highest points (peaks) or lowest points (troughs) on the trace.

6.3.3.2 - Maximum Number of Labeled Peaks

Causes only the highest peaks or lowest troughs, up to the total number of peaks/troughs indicated, to be labeled automatically.

6.3.3.3 - Format Labels

Size, Orientation & Number of Decimal Places lets you format the peak labels. For Orientation, 0° is horizontal; 90° vertical. You can have up to 4 decimal places in the label.

6.3.3.4 - Weighted Peak

Weighted Peak in combination with a Weighted Range (centered on the highest/lowest positioned pixel) lets the system calculate and label a weighted mean to represent the peak or trough.

NOTE: The Weighted Peak feature works best on peaks or troughs which are symmetrical about the highest/lowest point.

6.3.3.5 - Pixel Peak

The system can label the Pixel Peak, the highest/lowest positioned pixel.

6.3.3.6 - Label peaks in all Overlaid Spectra

You can also choose whether to Label peaks in all overlaid spectra or to have peaks labeled only on the active trace. See the following subsection on Overlaying Data.

6.3.4 - 3D Display Preferences

When 3D display mode is selected, the following options are available from the Display preferences dialog box:

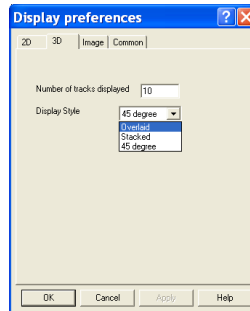

You can display multiple tracks and either **Overlaid** on one another:

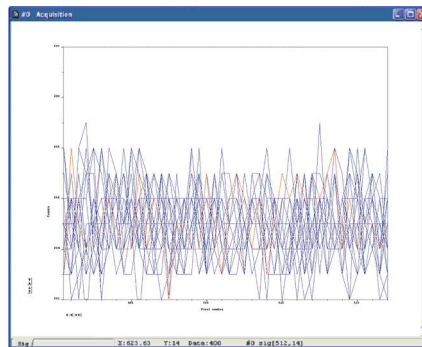

or **Stacked**:

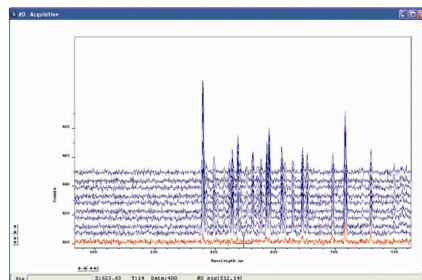

or at **45 degrees**:

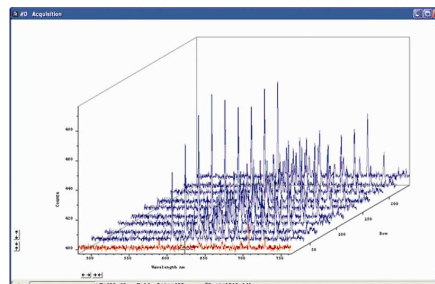

6.3.5 - Image Display Mode Preferences

When the Image tab on the Display preferences dialog box is selected, the following options are made available:

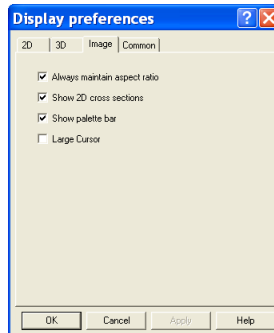

6.3.5.1 - Always Maintain Aspect Ratio On

When the **Always Maintain Aspect Ratio** option is ticked, 2 special buttons appear on the data window as shown:



Clicking these buttons causes the scales on both the vertical and horizontal display axes to stretch or shrink proportionately to one another, giving the impression of zooming in towards or zooming out from the image, while maintaining the original proportions of the image.

6.3.5.2 - Always Maintain Aspect Ratio Off

When the Always Maintain Aspect Ratio option is deselected, the following buttons appear instead of those shown previously:

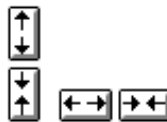

Clicking these buttons allows you to stretch or shrink the scale on either the x- or y-axis.

This creates the effect of Zooming In or Zooming Out in either the vertical or horizontal dimension.

6.3.5.3 - Show 2D Cross Sections

When Show 2D Cross Sections is selected on the Display Preference dialog box, 2D Side Traces are displayed parallel to the vertical and horizontal edges of the display area, e.g.:

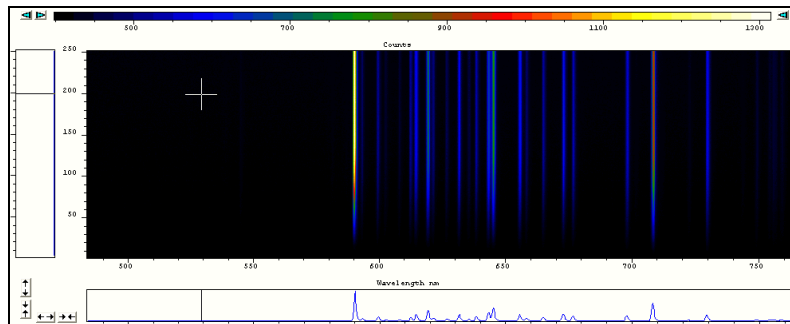

The long edge of each Side Trace is calibrated in the same units as the corresponding edge of the display. Plotted against the unmarked 'short edge' of the vertical and horizontal Side Traces are the data values taken (respectively) along a vertical or horizontal line running through the cross-hair. See **Large Cursor** below.

NOTE: If you are displaying data in Image display mode and resize the data window, so that it occupies only a small screen area, the system removes the side traces and the Zoom In/Zoom Out buttons. In this 'Display Only' mode the zoom box is also disabled and this is of benefit if you want to review many data windows simultaneously in Image display mode.

6.3.5.4 - Show Palette Bar

Show Palette Bar causes the black and white (or false color) palette and its control to be displayed or removed e.g.:

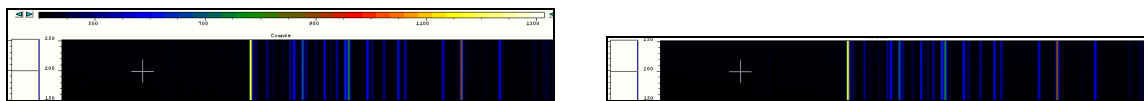

The arrow buttons at either end of the palette bar can be used to adjust the manner in which values are mapped against colors, and so change the brightness and contrast of the image.

6.3.5.5 - Large cursor

When the **Large Cursor** option is selected, the cross-hairs run the full height and width of the display, e.g.:

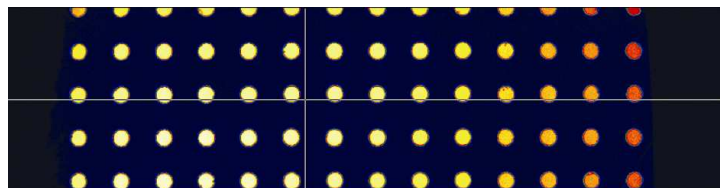

This makes it easier to identify the corresponding points on the Side Traces.

6.4 - AXIS SETUP

When you are in 2D or 3D display mode and the Axis Setup option on the Display menu is selected, the Axis Setup dialog box opens as shown:

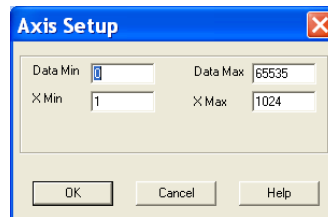

The minimum & maximum values you wish to appear on the x- and data-axes (the horizontal and vertical display axes respectively) of your data window can be entered in the text boxes.

If you select Axis Setup while you are viewing data in Image display Mode, the Axis Setup dialog box opens as shown:

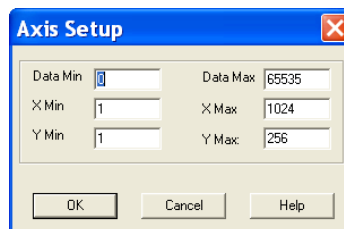

You can now also enter, in the text boxes, minimum & maximum values for the y-axis (the vertical display axis) of your data window. In a full resolution image, data are represented as a color or a grayscale tone.

You can now enter minimum & maximum x- and y- values of your choice, provided those values (when converted to pixels) do not exceed the width or height of the CCD-chip.

However, if you have selected Always Maintain Aspect Ratio in Preferences, the system may have to resize the 'plotting region' in which the image appears: the plotting region then generally occupies less of the available window space, but the aspect ratio is maintained.

NOTE: If you want the system to use the maximum available window space, either resize the data window or Click the reset button.

6.5 - ZOOM BOX

- In 2D & Image modes, you can also zoom into an area by drawing a Zoom Box. In both instances, hold down the primary mouse button and pull the cursor in a diagonal across the screen around the area that you are interested in.
- In 2D mode, the top and bottom edges of the zoom box demarcate the range of values that will be shown over the full height of the data-axis. Having drawn the zoom box, release the mouse button to perform the zoom operation. The minimum zoom width is 30 pixels.

NOTE: You may wish to perform a Rescale (see page 100) on data you have just zoomed. Rescale will plot all recorded data values that fall within the new, zoomed range of the X-Axis against a newly calibrated Data-axis. In this way you will be able to see peaks and troughs that may have been clipped off by your zoom box.

- In Image mode, release the mouse button to perform the zoom operation. The image will zoom to show the selected area in greater detail. The minimum zoom area is 30 x 30 pixels.

If you have selected **Always Maintain Aspect Ratio**, you may find that an area slightly larger than the zoom box has been expanded. The system adds extra area as necessary so that the zoomed image accurately represents the height to width ratio of the individual pixels on your CCD-chip.



NOTE: To help the system zoom the area you require, draw the zoom box in similar proportions to the height and width of the image display.

6.6 - ZOOMING & SCROLLING

The following functions are available in data windows whilst in 2D & 3D Display modes:

- Zoom in
- Zoom out
- Scroll

6.6.1 - Zoom In & Zoom Out

On a data window in 2D or 3D display mode, pairs of Zoom In:  and Zoom Out:  buttons are provided on both the x- and data-axes of the trace.

The buttons allow you to stretch or shrink the scale (to cover a smaller or larger range) on either the x- or data-axis, creating the effect of zooming in or zooming out in either the vertical or horizontal dimension of the display.

6.6.2 - Scrolling

If you have stretched a scale by zooming, you can slide the scale to cover a different range and the display will scroll in synchronization with the moving scale. Place the cursor arrow over the scale so that it changes to a finger flanked by arrows. Now pressing the primary mouse button allows you to 'slide' the scale up and down (or left and right), and scroll the display.

If you place the finger cursor at either end of an axis you will notice that a single arrow appears beside it, indicating the direction in which the scale will slide automatically when you depress the primary mouse button. The display 'fast scrolls' accordingly.

6.6.3 - Reset

Clicking the  button when a Data Window is open, returns the displayed data to its original configuration, thus undoing any adjustment to scale that you may have performed in accordance with the descriptions given in Zooming In, Zooming Out, Scrolling and Rescale (shown on **page 100**). Reset is available for all display modes.

6.7 - 2D DISPLAY MODE

To view data in 2D, either select 2D from the drop-down menu or click on the  button. Data is then displayed as an unlabeled trace, e.g.:

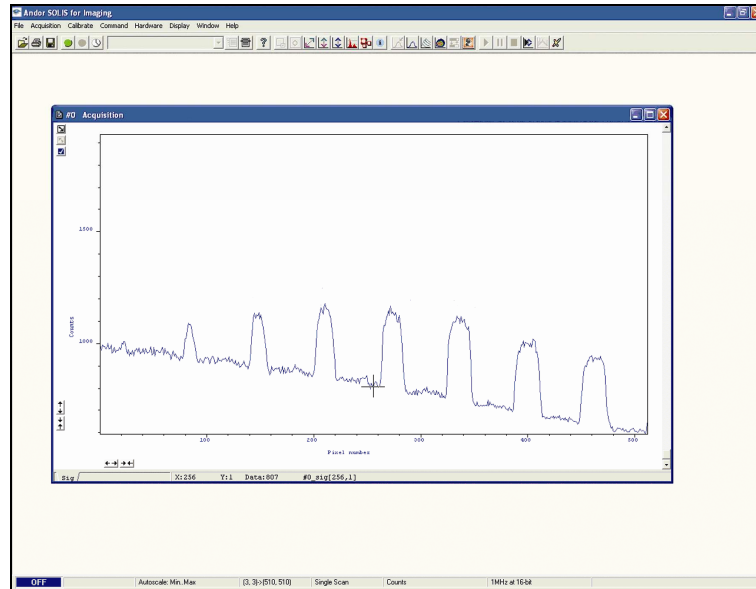

6.7.1 - 2D with Peak Labeling

To label peaks automatically, either select 2D from the drop-down menu or click the  button. The data window display will change e.g. :

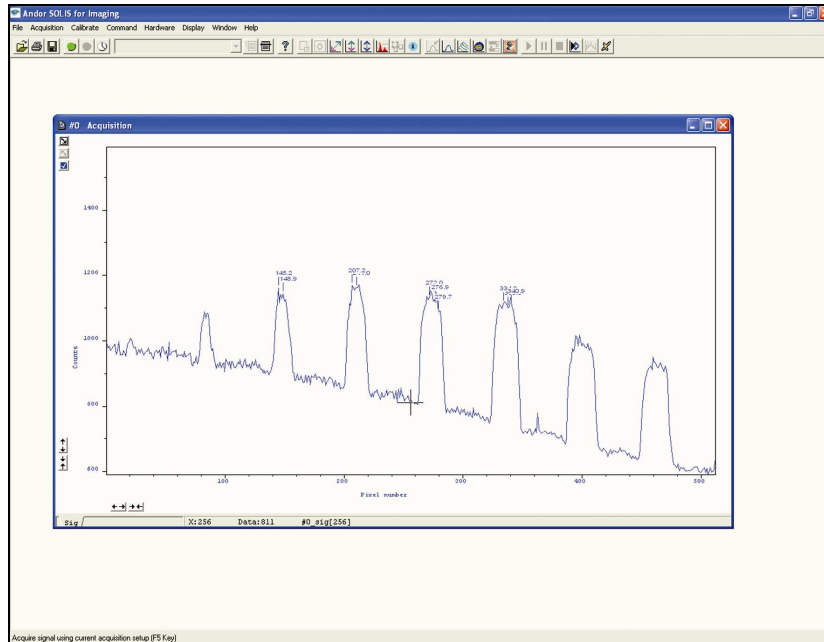

When labeling is selected, you can label a peak manually by double clicking on it.

To remove a peak label, double click it again. If you switch off peak labeling, by clicking the  button, the manual labeling will be lost.

NOTE: To manually label peaks accurately it is best to zoom in on the trace as described on page 89.

By default, the x-axis will be calibrated in pixels (1 on the x-axis corresponds to the position of the first column of pixels on the CCD-chip, etc.). The data-axis will by default be calibrated in counts. For details of how to change the calibration on the x-axis, please refer to **Section 8**.

If you have acquired data in an imaging mode you will be able to view the data from each track on the CCD-chip (or row if you have acquired a Full Resolution image).

To view the traces from each track or row individually, use the scroll bar on the data window. The numeric display on the bottom edge of the data window will indicate which track or row you are currently viewing.

NOTE: If there is only one track of data, no track or row number will be displayed, nor will there be a scroll bar.

If you have acquired data as a Kinetic Series, you may also use the scroll bar to move between the members of the series. The display on the bottom edge of the data window will indicate which member of the series you are currently viewing.

To read off a data value, click on the trace to position the cursor on the point of interest (you may need to use the left and right arrow keys on your keyboard to position the cursor precisely). The numeric display on the status bar along the bottom edge of the data window will indicate the corresponding x- and data-values.

6.7.2 - Overlay

The ability to Overlay data traces is useful if you wish to compare several traces on the same axes. You can display up to nine 2D traces simultaneously in the same data window on the same set of axes. The data window in which you intend to display the overlaid traces must be in 2D display mode. Only the data which were originally in that data window can be saved or modified when the data window is active.

You cannot, for instance, use the data window to calibrate traces that have been added as overlays. The data window from which the 2D overlays are taken can be in any display mode.

To add an overlay, click the  button on the Data Window. The Add Another Trace To Display dialog box appears:

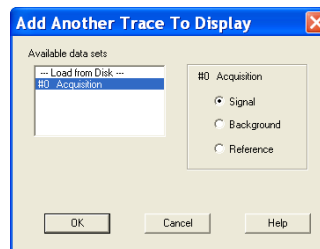

The selection list displays the names of data sets that are already being displayed in a data window or you may select data that you have previously stored to disk (the Load from Disk option). Buttons also let you specify Signal, Background or Reference data (if these are contained in the data set you have selected for overlay).

When you have made your selection and clicked OK, the display changes, e.g.:

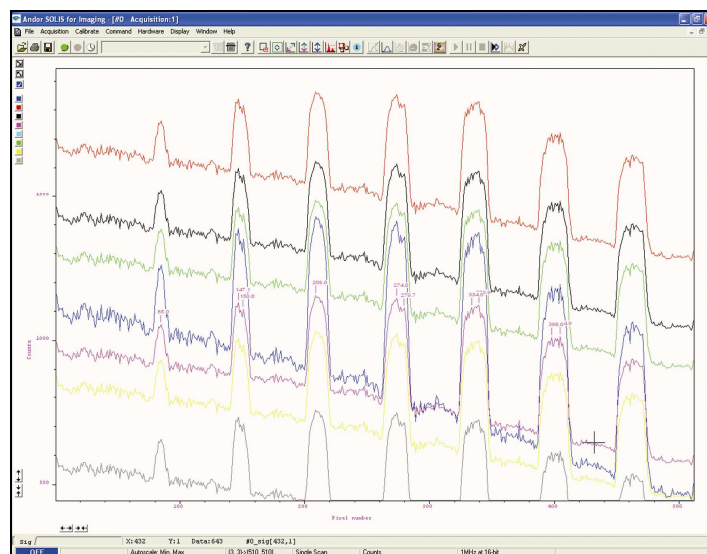

NOTE: You can add up to a maximum of 8 overlays to your original data trace.

6.7.2.1 - Active Trace

The original data trace is always displayed in blue. Each new overlay appears in a unique identifying color and an Active Trace button is displayed on the left in the same color. To manipulate the trace you want, click on the Active Trace button corresponding to the color of the trace you wish to work with. The values on the horizontal and vertical axes will change to correspond to the Active Trace and will be presented in the same color as the trace itself. Once active, a trace can be manipulated the same manner as any 2D Display. If you try to add too many traces, you will be prompted with the following message:

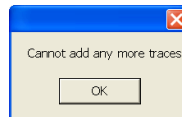

6.7.2.2 - Overlay & Keep

The Overlay and Keep feature is used only with 'live' data acquired into the #0 Acquisition Window.

If you have just acquired data that you think you might want to compare with subsequent data, click the  button. In the Acquisition Window you will see the 'live' trace in blue along with an overlaid copy. In addition, you will see a new data window containing the selected data. The new data window is minimized at the bottom of the screen, e.g.:

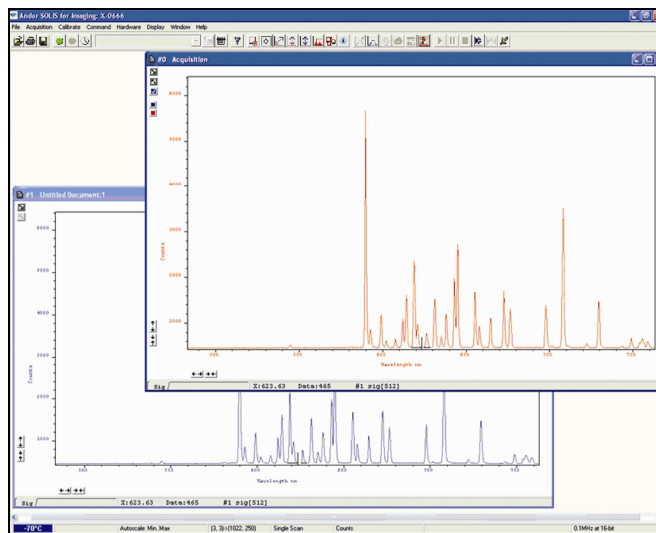

At a later stage you may choose to save the contents of this new data window to file.

6.7.2.3 - Scale to Active

If you have overlaid a number of traces, the **Scale to Active** option becomes available on the Display Menu. When Scale to Active is selected, all the data traces in your data window will be plotted against the scales of the active trace, e.g. :

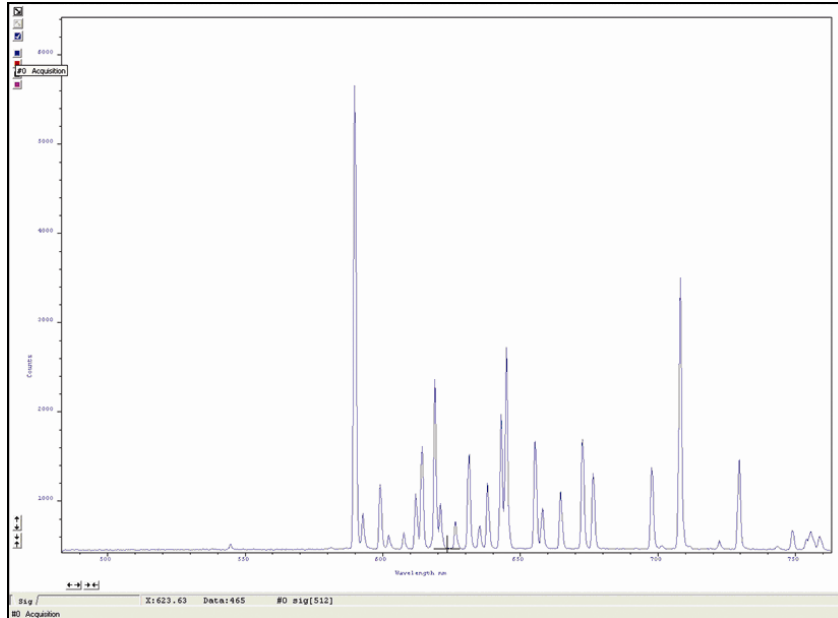

Vertical axes will be rescaled even if the units do not match those of the active trace.

6.7.2.4 - Remove Overlay

If you want to remove an overlay, first make sure that it is the Active Trace then click the  button. If necessary use the **Active Trace** buttons to select a new active trace.

6.8 - 3D DISPLAY MODE

If you have acquired data in Imaging mode or as a Kinetic series you can view the traces taken from all the rows or tracks on one set of axes in a data window. Select the 3D option from the Change Display Mode option on the Display menu, or click the  button. A data window will appear e.g.:

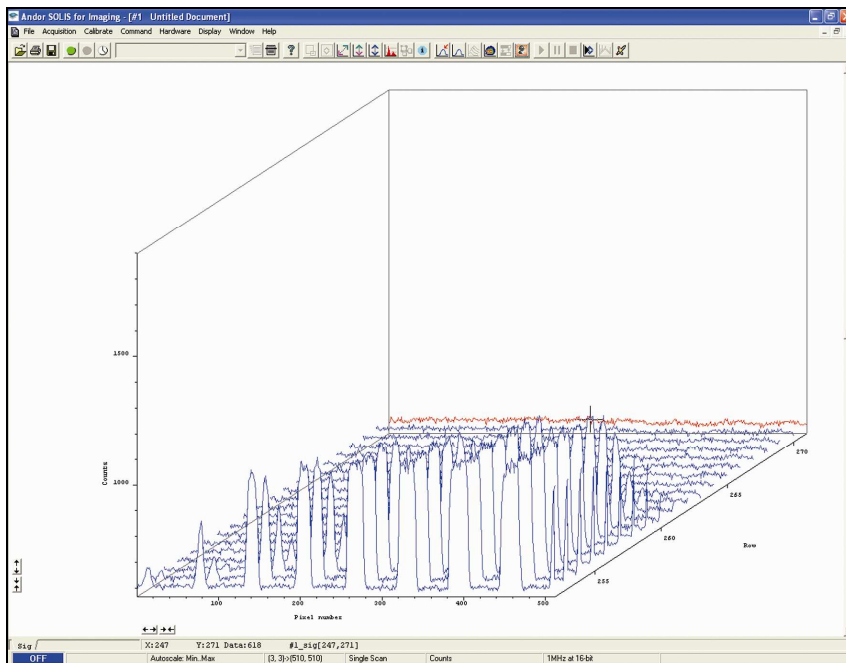

Along with the x-axis (calibrated by default to represent pixels across the CCD-chip) and the data-axis (calibrated by default in counts), you now see a 3rd (or y-axis) calibrated in rows or tracks, depending on the acquisition mode you have selected.

To read off a data value on a particular trace, use the scroll bar on the data window to move the trace into the plane delineated by the x- and data-axes, and click on the trace to position the cursor on the point of interest (you may need to use the left and right arrow keys on your keyboard to position the cursor precisely).

The numeric display on the status bar along the bottom edge of the data window will indicate the series member on which the cursor is positioned ('Kinetics'), along with the corresponding x- and data-values.

If your data set contains a series of images (each of which may represent data acquired in Kinetics Mode) you will notice that the data window has two scroll bars, placed end to end. The upper scroll bar allows you to move between the members of the series, while the lower scroll bar allows you to view the traces that make up the particular member of the series.

NOTE: The Zooming, Scrolling and Reset functions are the same as for 2D mode.

6.9 - IMAGE DISPLAY MODE

Data acquired in Imaging mode can be viewed as an image in a data window. For best results you should set your computer display to 256 colors and adjust the color or brightness using the controls associated with the Palette Bar (see below).

Select the Image option from the Display drop-down menu or click the  button and an image will appear, e.g.:

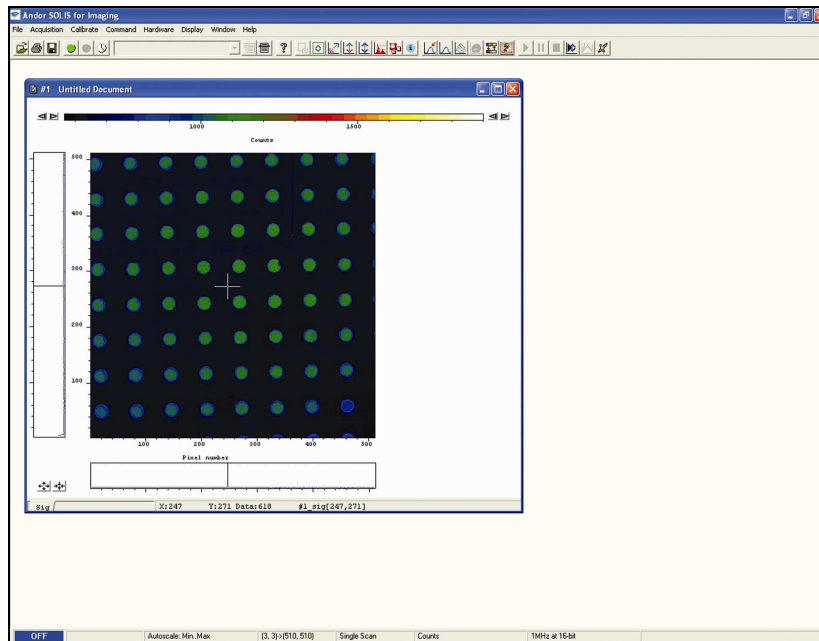

The cross-hair moves to any point on the image that you click. The data value for the point, along with the pixel numbers on the x- and y-axes that identify the point, is displayed on the bottom edge of the data window.

NOTE: If your data set contains a Kinetic Series, each member of which has been acquired in an Imaging mode, you will notice a vertical scroll bar that allows you to move between the images that make up the series. The number of the member of the Kinetic Series is also displayed on the bottom edge of the data window.

6.9.1 - Palette Bar

The **Palette Bar**:  which runs across the top of the data window, always shows the full palette of grays or colors available in each color mode. The palette is graded so that lower data values correspond to the darker tones to the left of the palette, and higher data values correspond to the brighter tones to the right of the palette.

The arrows to the left of the Palette Bar on the data window allow you to adjust the minimum distinguishable data value (i.e. min, the value at which the Palette Bar becomes black), e.g.:

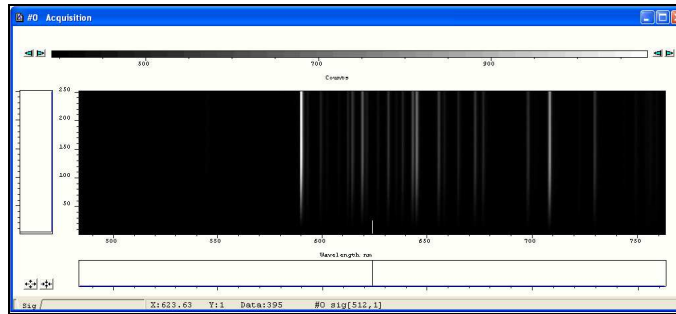

The arrows to the right of the Palette Bar on the Data Window allow you to adjust the maximum distinguishable data value (i.e. max, the value at which the Palette Bar becomes white), e.g.:

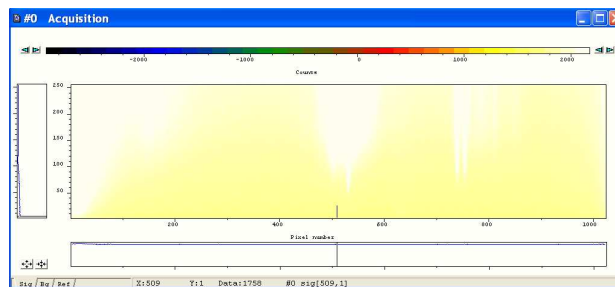

The scale on the Palette Bar is calibrated in your chosen data units. By default, the full range of colors/grays is correlated with the full range of data in your data set. This is known as “Rescaling” (please refer to **Rescale** on page 100).

Adjusting the Brightness & Increasing and Decreasing Contrast later in this section explains how you can use these controls to change the brightness and contrast of the display.

The display appears initially in grayscale, e.g. :

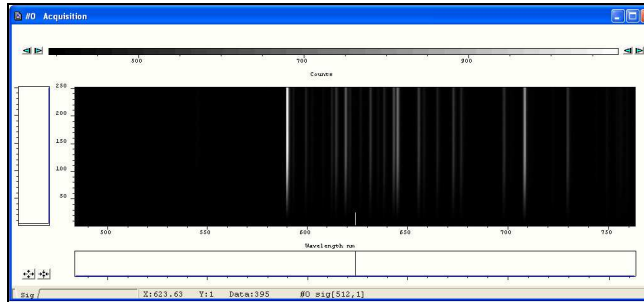

Clicking on the  button causes the data window to cycle through the following 2 modes:

- **Color**, e.g.

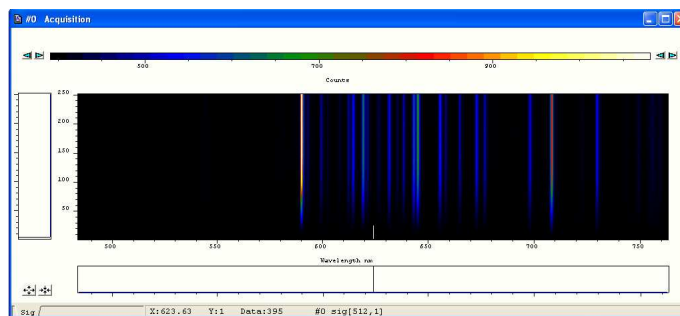

- **Iterated Grayscale** (a small sequence of grays is repeated at intervals to cover the same range of data as grayscale), e.g.:

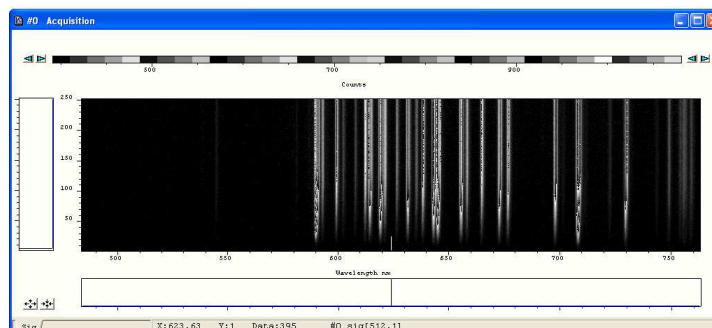

6.9.3 - Rescale

When a data window is open and you click on the  button on the button bar of the Main Window, the system displays against an appropriate data scale all data that falls within the range selected on the x-axis. In Image Display Mode, it will also be displayed in appropriate colors or grayscale tones.

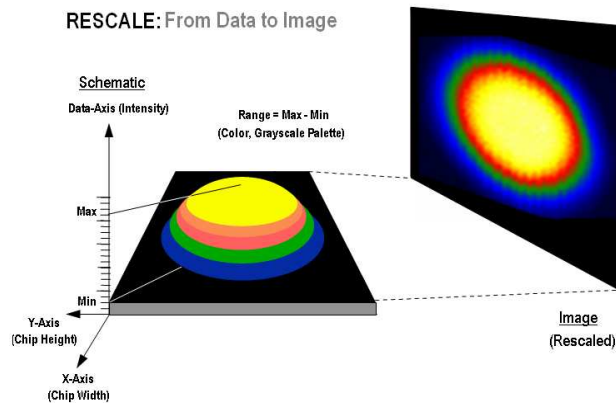

From the Rescale Data Mode menu of the Display drop-down menu, you can also select the maximum number of counts that can be recorded for a single pixel, your rescaled data distinguishes values between the following parameters:

- Minimum and Maximum (Min..Max)
- Zero and Maximum (0..Max)
- Zero and 65535 (0..65535)
- Minimum and 65535 (Min..65535)
- Custom Setting. When Custom.. is selected, the Custom Autoscale dialog box appears, e.g.:

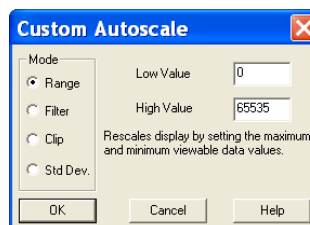

Autoscale Acquisition performs a similar function for the display of data as they are being acquired. It can be selected either from the Acquisition drop-down menu, or by clicking the following buttons:

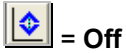
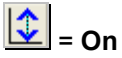

You can also press **F6** on the keyboard.

Rescale is available for all the Display Modes. The following comments take rescaling in Image display mode as a specific example. Image display mode is used to display the members of a Kinetic Series as an image (each member of the series forms a row of the image.)

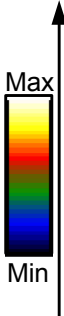
<p>Data-Axis</p> 	<p>The computer rescales your display by default. The full available palette of colors/grays is correlated with the full range of data you have acquired.</p> <p>When it rescales in Image display mode, the computer defaults to Minimum (Min) and Maximum (Max) and scales the available number of colors to the range.</p> <p>Alternatively, depending on the rescale submenu item you have selected, the range may be between 0 and Max, or between 0 and 65535.</p>
---	--

Rescale

For various reasons (e.g., a cosmic ray may produce a data 'peak' that is unrepresentative of data levels generally), rescaling may not adequately illustrate the features of the data you are most interested in. To emphasize or de-emphasize particular features, you can adjust the contrast and/or the brightness of the display. See **Increasing & decreasing contrast** and **Adjusting the brightness** on pages 103 & 105 respectively.

6.9.4 - High & low contrast overview

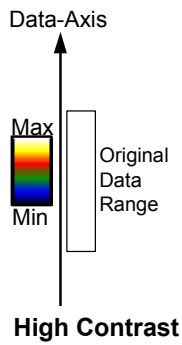

Assume your original data are rescaled.

To achieve high contrast, the computer scales a smaller range of data with the same number of colors as it used for rescaling.

Any data value greater than the maximum in the displayed data range is represented by the brightest color (white). Any data value lower than the minimum in the displayed data range is represented by the darkest color (black).

Now only a fraction of the original data range is represented by the total number of colors.

Decreasing the displayed data range produces high contrast.

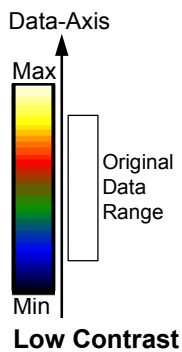

To achieve low contrast, the computer scales a larger range of data with the same number of colors as it used for rescaling. Thus the original data are represented by a smaller range of colors.

Increasing the displayed data range produces low contrast.

6.9.4.1 - Increasing & decreasing contrast

You can use the pairs of left-right arrows at either end of the Palette Bar to increase or decrease the displayed data range (i.e. “shrink” or “stretch” the scale on the palette) and thereby alter the contrast of the data shown in Image display mode. You can also use the + and – keys to do the same function.

The diagrams to the right illustrate the following:

Increasing the displayed data range (‘shrinking’ the scale).

Decreasing the displayed data range (‘stretching’ the scale).

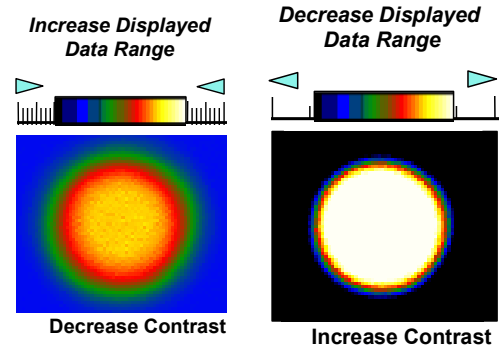

By holding down the left-right arrows at either end of the Palette Bar you can alter the minimum and maximum values in the displayed data range independently of each other, and so adjust the contrast to the level you require. As you hold down the arrows (place the cursor over an arrow button and hold down the primary mouse button), observe carefully how the scale changes and how the displayed data range is affected. If you wish to undo your changes, use Rescale.

NOTE: When the left - right arrows are held down for a time, you will see the display flash periodically as the system performs the contrast adjustment. These flashes occur as the system refreshes the color palette to cover your new displayed data range. Hold the arrows down until you reach your required contrast level.

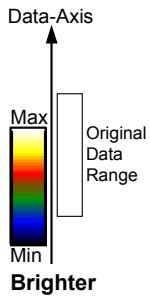

To make the data shown in Image display mode brighter, the computer uses the same number of colors as it used for rescaling to scale lower data values.

Thus any data originally represented by darker colors are now represented by brighter colors.

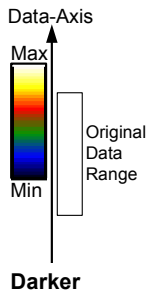

To make the data shown in Image Display Mode darker, the computer uses the same number of colors as it used for rescaling to scale higher data values.

Thus any data originally represented by brighter colors are now represented by darker colors.

NOTE: If you wish to undo your changes, use Rescale.

6.9.5.1 - Adjusting the brightness

You can alter the brightness of the data shown in Image display mode by moving the displayed data range so that it covers higher or lower data values.

To move the displayed data range, place the cursor on or just below the Palette Bar (the cursor changes to a finger) and, holding down the primary mouse button, 'slide' the scale on the palette to the left or right.

Sliding the scale to the right means that the displayed data range covers lower data values (the numbers on the scale decrease).

The display then becomes brighter as shown on the right.

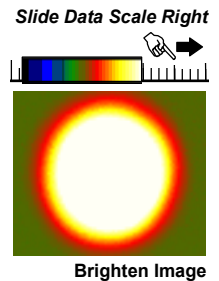

Sliding the scale to the left means that the displayed data range covers higher data values (the numbers on the scale increase).

The display then becomes darker as shown on the right.

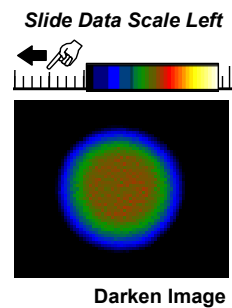

NOTE: When you slide the scale, you will see the image flash periodically as the system performs the brightness adjustment. These flashes occur as the system refreshes the color palette to cover your new displayed data range. Continue to slide the scale until you reach your required brightness level.

6.10 - DATA HISTOGRAM

The Data Histogram dialog box is launched either by clicking on the  icon on the Main Window, or selecting Data Histogram from the Display drop-down menu. This tool allows you to plot a histogram, or graph, between the maximum and minimum data points in the displayed range. It also contains a filter drop down menu, which allows for more accurate analysis and presentation of data values.

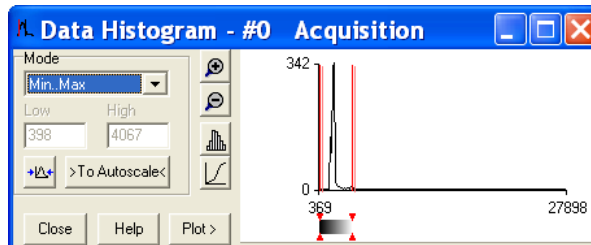



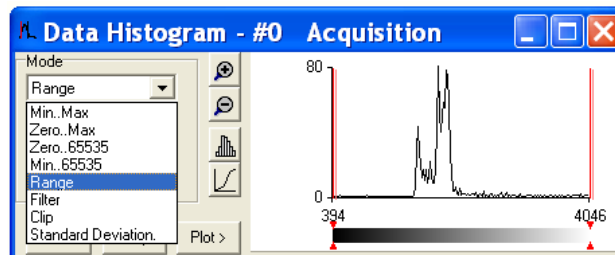

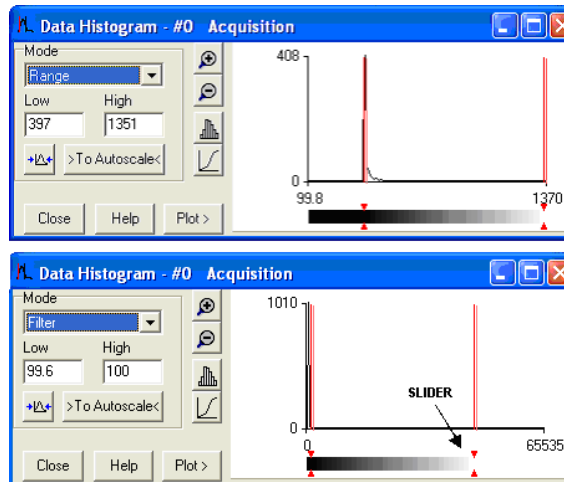

By clicking on an open data window, its histogram will be displayed on the Data Histogram dialog. When plotting the histogram, the focus is transferred to the new data window and the displayed histogram is that of the plotted histogram. The data from which the histogram is displayed is indicated on the title bar of the Data Histogram dialog. To return the focus on the original data, click on the original data window. Modes to view specific areas of spectra can be selected through the drop-down menu:

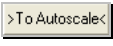

Values can be modified either by typing in the new values in the Low and High text boxes or by dragging the red arrows and bars below the histogram, e.g.:



- **Update:** Any change on the mode and/or the Low/High values is updated when the  button is clicked.
- **Autoscale:** After clicking the  button, acquisitions that follow will use these scaling settings as default.
- **Expand to bounds:** clicking on the  button zooms in on the histogram.
- **Zoom Out:** clicking on the  button zooms out of the histogram.
- **Bar Chart:** clicking on the  button toggles between x-y and bar chart histogram display.
- **Cumulative:** clicking on the  button toggles between cumulative (integral) and non-cumulative histogram display.
- **Plot:** clicking on the  button plots the histogram into a data window.

6.11 - REGION OF INTEREST

Region of Interest (ROI) is an important post-acquisition tool, used for quantitative analysis and it can be selected either by clicking the  button or selecting Region of Interest from the Display drop-down menu. When ROI is selected, the following dialog box opens:

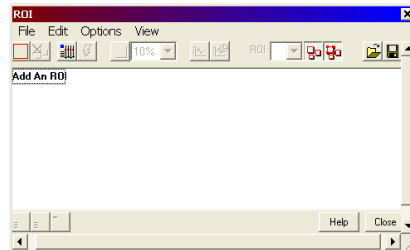

An ROI can be drawn on the image by positioning your cursor on the red ROI, and dragging out the using the corner handles.

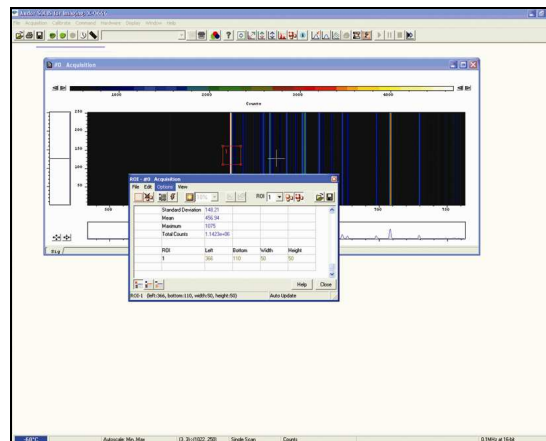

You can use this tool to select and draw multiple ROI's onto your image, then use the ROI data set to compare the values obtained, e.g.:

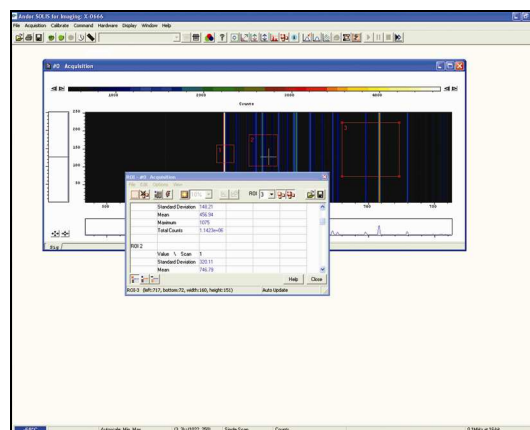

There are 3x buttons in the bottom-left of the ROI dialog box:

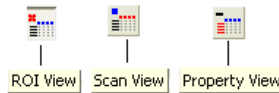

- Clicking the **View** button will present and group your ROI data, according to each individual ROI region selected on the image. It will also display the pixel co-ordinates of all the ROI's for that scan, e.g.:

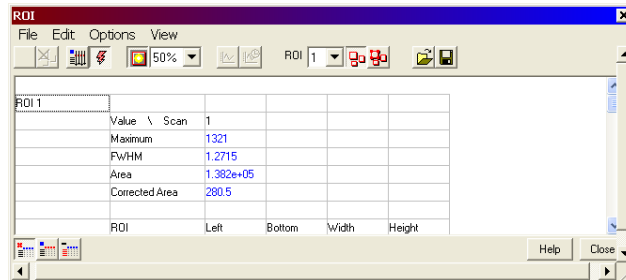

- Clicking the **Scan** button will present and group your ROI data, according to individual data scans. It will also display the pixel co-ordinates for all the ROI's for that scan, e.g.:

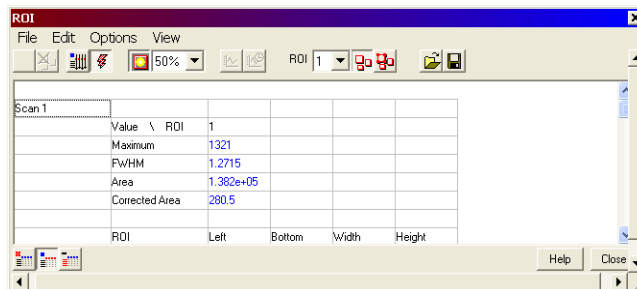

- Clicking the **Property** View button will present and group your ROI data, according to value regions, i.e. Mean, Range and Standard Deviation. It will also display the pixel co-ordinates for all the ROI's for that scan, e.g.:

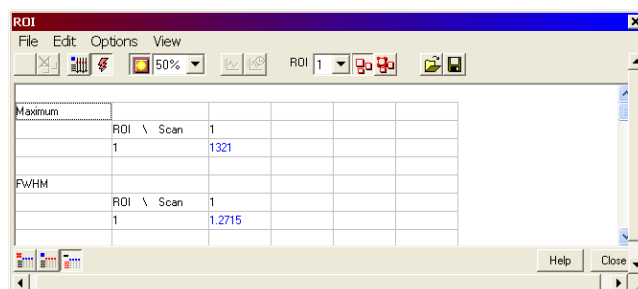

The ROI can be switched on and off by clicking the  (**Show ROI**) button. When Show ROI is selected on, the selected ROI will be displayed and outlined by red boxes, e.g. for Full Vertical Binning.:

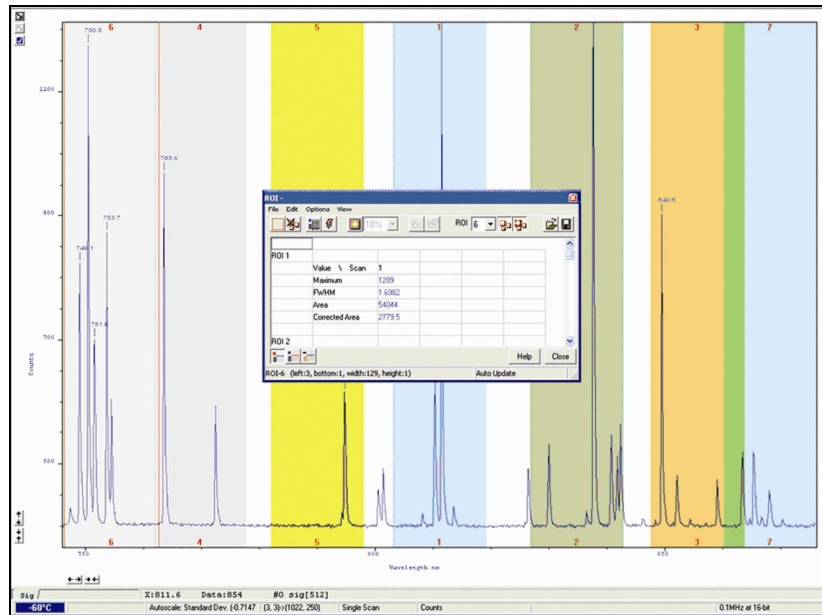

When Show ROI is selected **Off**, the red ROI boxes are hidden.

NOTE: When Show ROI is selected On, it is not possible to position the cross hair cursor on the image to perform Zoom In or Zoom Out functions.

The Edit ROI function is only available when Show ROI is selected On.

To activate, click on the  (Edit ROI) button. You can then change the size and location of the ROI's.

NOTE: When the Edit ROI tool is selected Off, the red ROI boxes are locked and cannot be altered. This is useful tool to prevent accidental interference with ROI's.

The current ROI (including the ROI data set) can be deleted by clicking on the  (**Delete current ROI**) button.

6.11.1 - ROI counter



The ROI Counter identifies the current active ROI. It can also be used to select and isolate a particular ROI, which can be a useful tool, e.g. if two ROI's are overlapping or are layered on top of each other. By clicking the down arrow, you can also see how many ROI's are currently defined.

6.11.2 - Hot Spot Approximation

Hot Spot Approximation can be used to take a selected percentage of the highest data values within a given ROI.

To select, click on the  button, then select the % required from the drop-down menu. For example selecting 50% will give you the mean value for the top 50% of pixel values within the ROI.

6.11.3 - Recalculate

To recalculate the values in the ROI window, click on the  button.

6.11.4 - Live update

You can receive and calculate ROI data, while the system is acquiring a Kinetic Series or running in Real Time Mode.

To select, click on the  button. The software is then able to acquire data and at the same time calculate and tabulate ROI data.

6.11.5 - Maximum Scans

When the Maximum Scans is selected from Options drop-down menu of the ROI dialog box, the Maximum Scans dialog appears, e.g.:

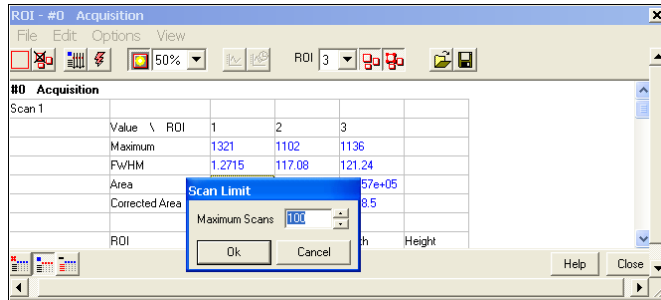

You can then enter the length of the history buffer you require (i.e. the number of previous values stored when acquiring in Real Time Mode with the Live Update feature enabled).

NOTE: This defaults to 100 and can be modified for longer series.

6.11.6 - Plot Series

Select any data value for a particular ROI and series position and the following buttons become available:



Clicking on these buttons will create a new dataset window displaying the currently selected property values plotted against series position or time.

6.12 - TIME STAMP

When the  (**Time Stamp**) button is clicked, the **Display Preferences** dialog box opens as shown:

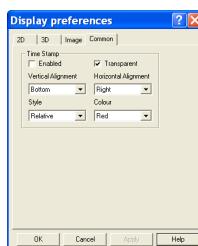

The Time Stamp feature allows you to add to the display the time at which the acquisition, or each scan in a kinetic series, occurred., e.g.:

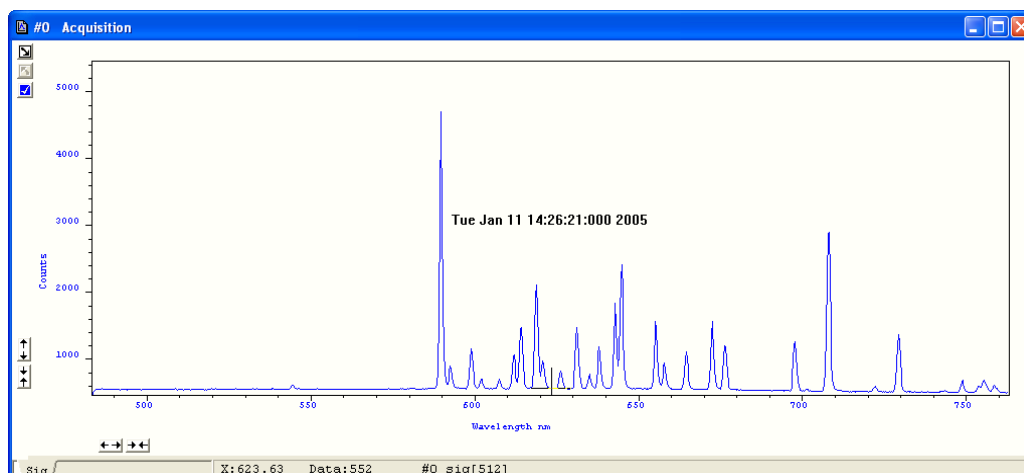



- Time & date information (or time relative to the start of the acquisition) can be displayed by selecting **Enabled**, then selecting the appropriate option in the **Style** drop down list.
- The position of the time stamp within the display can be set by adjusting the **Vertical & Horizontal Alignment** controls.
- The color of the text can also be changed.
- The time can be made to print on a solid background by de-selecting **Transparent**.

To remove the Time Stamp from the display de-select **Enabled**

6.13 - PLAYBACK

After a Kinetic series acquisition has been taken, it can be played back again for analysis.

- To replay, click the  button and the acquisition will display again as taken
- To pause, click the  button
- To stop, click the  button

Playback autoscale performs a similar function to Autoscale acquisition and is selected from the button on the top of the main window, i.e.:

 = On

 = Off

The sequence can also be viewed with different parameters set.

Select **Sequence options** from the Display drop-down menu and the **Sequence Setup** dialog box appears, e.g.:

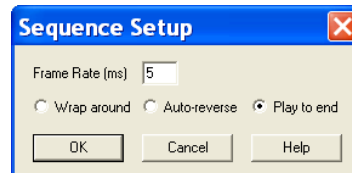

Select the parameters as required, click OK then playback the sequence as normal.

NOTE: This can be exported as an MPEG or other similar file for use in presentations, etc. Please refer to Section 7 for further details on Handling Files.

SECTION 7 - HANDLING FILES

7.1 - MENU OPTIONS

The File drop-down menu on the Main Window has the following options:

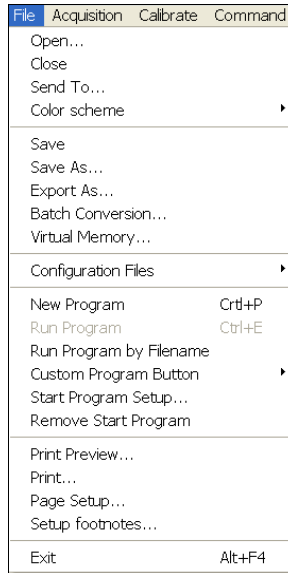

Some of the options available are typical “Windows facilities” to **Open, Save, Print** files, etc, but some are specific to Andor’s software to let you create or run programs.

7.1.1 - Open

Selecting **Open...** from the drop-down menu or clicking on the  button opens a standard dialog box, e.g.:

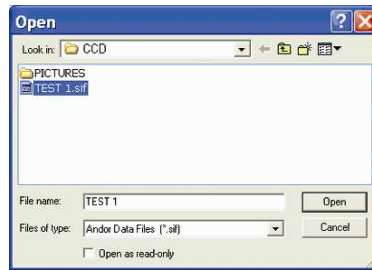

If you select a **Data file (.sif)**, the system launches a data window with the appropriate file displayed, e.g.:

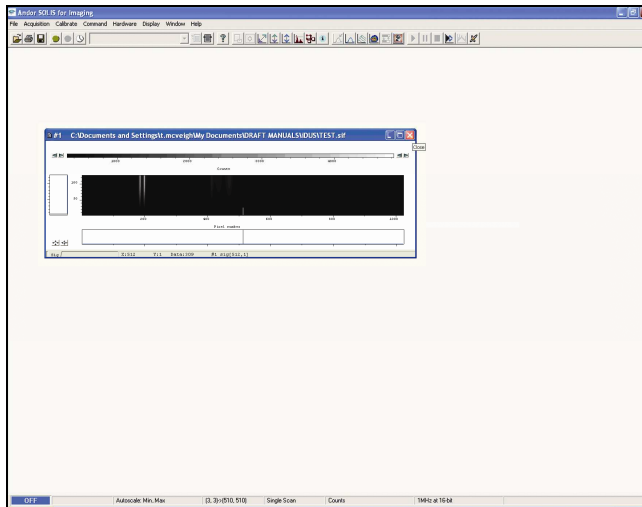

If you open a **Program file (.pgm)**, the system launches a **Program Editor** window and makes available a selection of editing tools on the Main Window, e.g.:

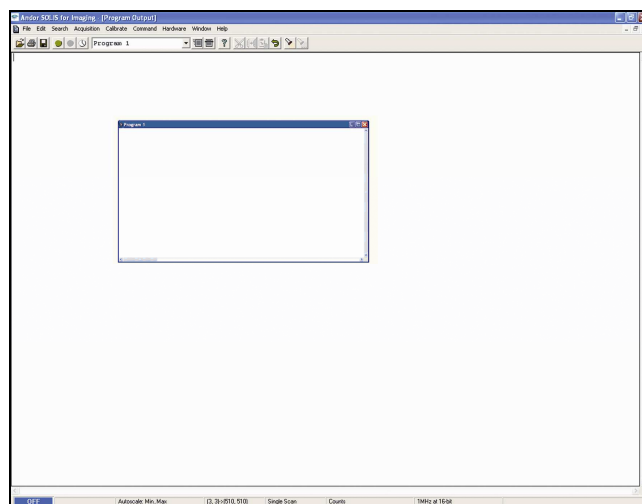

7.1.2 - Close

Close removes the active Data Window or Program Editor Window from the Main Window. You will be prompted to save any unsaved data to an appropriate filename.

7.1.3 - Save

Selecting Save from the dropdown menu or clicking  stores the contents of an active and previously saved Data Window or Program Editor Window under the current filename.

7.1.4 - Save As

Save as... launches the Save As dialog box, which lets you save the contents of an active Data Window or Program Editor Window under a filename and in a directory of your choice.

NOTE: If data is saved as a .sif file, the information contained within file information is saved. If the data is exported to another file type, the information within file information is lost.

Selecting **Export As...** from the drop-down menu opens the **Export As...** dialog box, e.g.:

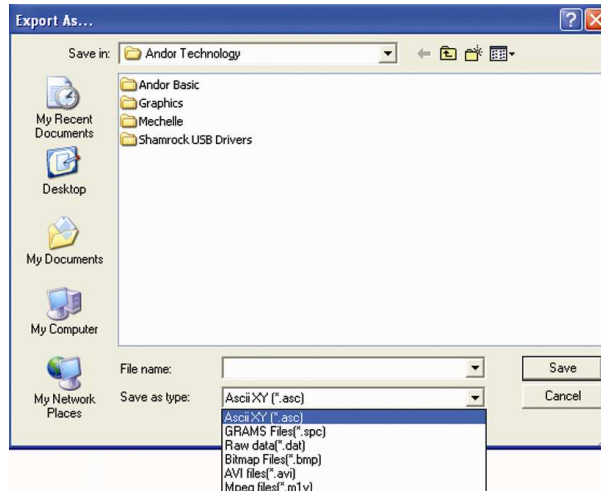

Depending on the Display & Readout modes selected, the file can be saved in one or more of the following formats:

- **ASCII (.asc)**
- **AVI (.avi)**
- **BITMAP (.bmp)**
- **GRAMS (.spc)**
- **JPEG (.jpg)**
- **MPEG (.m1v)**
- **RAW DATA (.dat)**
- **TIFF (.tif)**

Table 8 on the next page shows a matrix of the actual combinations available.

Table 8: File Export combinations

READOUT MODE	DISPLAY MODE	EXPORT OPTIONS							
		ASCII	AVI	BMP	GRAMS	JPEG	MPEG	RAW DATA	TIFF
FVB	2D	✓	✓	✓	✓		✓	✓	
	3D	✓	✓	✓	✓		✓	✓	
	IMAGE	✓		✓	✓	✓		✓	✓
Single-Track	2D	✓	✓	✓	✓		✓	✓	
	3D	✓	✓	✓	✓		✓	✓	
	IMAGE	✓		✓	✓	✓		✓	✓
Multi-Track	2D	✓						✓	
	3D	✓						✓	
	IMAGE	✓	✓	✓	✓	✓		✓	✓
Imaging	2D	✓						✓	
	3D	✓						✓	
	IMAGE	✓	✓	✓		✓	✓	✓	✓

ASCII (American Standard Code for Information Interchange) is the most common format for text files in computers and on the Internet. In an ASCII file, each alphabetic, numeric, or special character is represented with a 7-bit binary number. 128 possible characters are defined.

Exporting Data as ASCII text means you can subsequently import your data into other applications (such as spreadsheets) that use the ASCII format.

After you have selected ASCII XY (*.asc) from the Save as type drop-down menu, allocated a filename and clicked Save, the Save data as dialog box appears, e.g.:

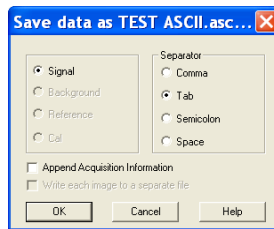

- The radio buttons on the left allow you to choose whether you want to save the Signal, Background, Reference or Cal (calibration) data from the live data set.
- The radio buttons on the right allow you to choose a character that will serve as a Separator between the numeric values in your raw data. You can then configure the importing application to recognize this separator (or delimiter) and in the case of a spreadsheet, display the data in a suitable configuration of rows and columns.

In an application such as Microsoft Excel you can perform this configuration by means of a wizard, launched automatically as you import the ASCII file.

Exporting data as ASCII text causes all the data associated with the data set to be exported, not just the portion of the data that is currently being displayed. Data which have been acquired through Single track or Full Vertical Binning will typically be displayed on a spreadsheet as a single column.

Data from acquisitions involving Multi-Track, Imaging or Kinetic Series are normally displayed in rows and columns. The columns represent the height (and/or the member of the kinetic series) and the rows the width of the CCD-chip.

7.1.5.2 - AVI

File extension = .avi

An **AVI** (Audio Video Interleaved) file is a sound and motion picture file that requires a special player.

After you have selected AVI files (.avi) from the Save as type drop-down menu, allocated a filename and clicked Save, the AVI Export dialog box appears, e.g.:

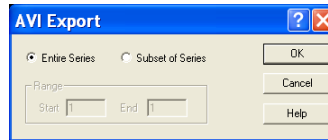

You can then select which series of data to export to the file.

7.1.5.3 - BITMAP

File extension = .bmp

BMP exports data in Microsoft Windows bitmap format that can be embedded into documents created in word processing and presentation packages, etc. If you adjust the image, it is the adjusted image that will be exported. After you have selected Bitmap Files (*.bmp) from the Save as type drop-down menu, allocated a filename and clicked Save, the file is saved.

7.1.5.4 - GRAMS

File extension = .spc

GRAMS (Graphic Relational Array Management System) is a software package that supports advanced data visualization and management. It is produced by Galactic Industries Corporation of Salem, New Hampshire.

After you have selected GRAMS Files (*.spc) from the Save as type drop-down menu, allocated a filename and clicked Save, the Export # dialog box appears, e.g. :

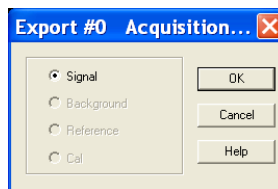

Provided data has been acquired in each format, you can select either Signal, Background, Reference or Calibration data from the active data set.

7.1.5.5 - JPEG

File extension = .jpg

JPEG (Joint Photographic Experts Group) is a group of experts that develops and maintains standards for a suite of compression algorithms for computer image files. JPEG is a term used for any graphic image file produced by using a JPEG standard.

When you create a JPEG or convert an image from another format to a JPEG, you are asked to specify the quality of image you want. Since the highest quality results in the largest file, you can make a trade-off between image quality and file size.

After you have selected Jpeg Files (*.jpg) from the Save as type drop-down menu, allocated a filename and clicked Save, the file is saved.

7.1.5.6 - MPEG

File extension = .m1V

MPEG (Moving Picture Experts Group) is a standard for digital video and digital audio compression. MPEG standards are an evolving series, each designed for a different purpose.

After you have selected Mpeg (*.m1V) from the Save as type drop-down menu, allocated a filename and clicked Save, the file is saved.

7.1.5.7 - Raw data

File extension = .dat

The .dat file comprises data only and has no header information of any kind. The original data set remains unchanged.

After you have selected Raw data (*.dat) from the Save as type drop-down menu, allocated a filename and clicked Save, the Export # dialog box appears, e.g.

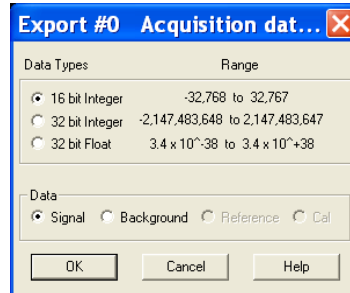

This allows the user to save a data set (currently in memory) to a file located on disk. A data set refers to a collection of data comprising one or more of the following subsets:

- **Signal**
- **Background**
- **Reference**
- **Cal**

A .dat file, however, will contain only one of the above data subsets.

NOTE: The Cal subset is used in radiometry/colorimetry measurements. It does not refer to the x-axis calibration of sig, bg or ref data.

The .dat file format reflects the CCD sensor format, e.g., with a CCD sensor of 1024 columns * 256 rows then the first 1024 data values in the .dat file correspond to the first row of the CCD, the second 1024 data values correspond to the second row, etc.

The .dat types range is shown in **table 9** on the next page.

Table 9: Types of .dat files

	DATA TYPE	NO. OF BYTES	RANGE
(1)	16 bit integer	2	-32,768 to 32,767
(2)	32 bit integer	4	-2,147,483,648 to 2,147,483,647
(3)	32 bit float	4	3.4×10^{-38} to $3.4 \times 10^{+38}$

(1) Saves a data set to a 16 bit integer **.dat** file.

NOTE: If a data value exceeds the limits of a 16 bit integer (<-32,768 or > 32,767), that data value is truncated to the corresponding limit (e.g. if a data value is 36,000 units then the value is truncated to 32,767 units).

(2) Saves a data set to a 32 bit integer **.dat** file. The limits for the 32 bit integer are handled in similar fashion to the 16 bit integer above.

(3) Saves a data set to a 32 bit floating point **.dat** file.

When using your own software to handle a **.dat** file, you have to work out how many bytes to read in. Each 32 bit value requires 4 bytes to handle the value. Thus, for example, to read in a 32 bit **.dat** file consisting of 1024 data values, you would have to read in 4096 bytes in total.

7.1.5.8 - TIFF

File extension = .tif

TIFF (Tagged or Tag Image File Format) is used for storing bitmapped images and is widely supported by commercial publishing packages.

After you have selected from the Save as type drop-down menu and allocated a filename, the **TIFF export** dialog box appears, e.g.:

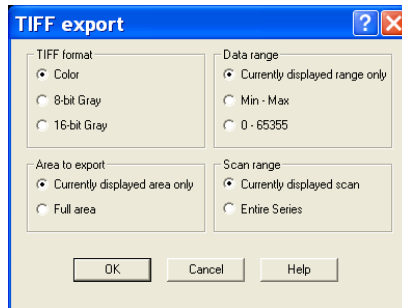

You can then choose the parameters you require to be displayed.

7.1.5.9 - Configuration Files

File extension = .cfg

A configuration file contains the values that appear on the system's dialog boxes whenever the application is launched, or whenever a configuration file is newly loaded. Using configuration files is an easy way to tailor the overall application set-up to suit particular experiments. Configuration files reside in the same directory as the executable (.exe) of the application itself. The factory-supplied configuration file (.cfg) contains typical default settings. Each time you start up the system, the .cfg is loaded automatically.

The files are accessed from the **Configuration Files** menu on the File drop-down menu of the Main Window as shown:

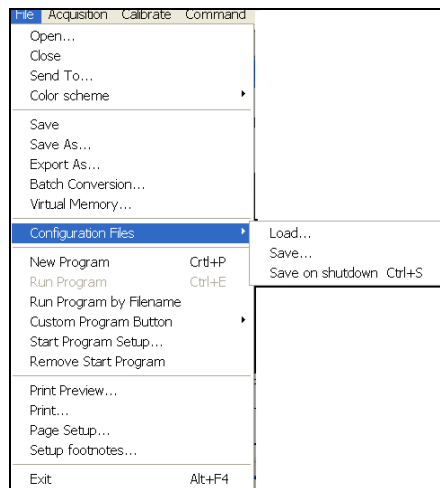

- **Load...** selects the configuration file you currently want to use. The system will immediately use the settings in the newly loaded file.
- **Save...** stores your current settings under a filename and in a directory of your own choice. You can, if you wish, overwrite an existing configuration file.
- **Save on shutdown** stores your current settings under a filename when the computer is shutdown.

7.1.6 - Program selection

The menus for working with Programs are selected from the File drop-down menu of the Main Window, e.g.:

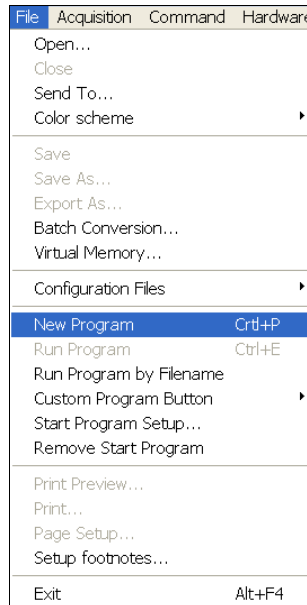

Working with Programs is explained in more detail in **Section 9**.

SECTION 8 - CALIBRATION**8.1 - INTRODUCTION TO CALIBRATION**

The following calibration options for data displays are available from the Calibration Menu on the Main Window:

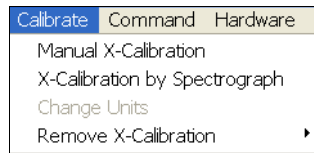

- **Manual X-Calibration:** lets you calibrate the x-axis of data displays by manually setting values (time, pixel number, wavelength, Raman shift or spatial position) against recognizable features of a particular 2D data trace.
- **X-Calibration by Spectrograph:** lets you calibrate the x-axis of your data displays with reference to your spectrograph's specifications. Calibration may be in wavelength or Raman shift.
- **Change Units:** lets you change the units on the x-axis of a data display (e.g. nm to μm , cm to pixel number, etc.)
- In addition, the option **Remove X-Calibration** has 2 further options:
 - **Current Data** returns the data in the active Data Window to its default pixel x-calibration.
 - **New Acquisitions** causes future data to be acquired with the default pixel x-calibration.

8.2 - MANUAL X-CALIBRATION

Using newly acquired or previously stored data, select **Manual X-Calibration** from the **Calibrate** menu. The **Manual X-Calibration** dialog box appears, e.g.:

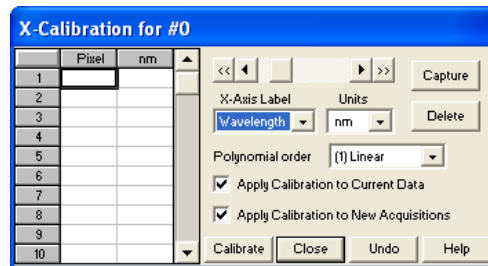

The number (#n) of the data window (or #0 in the case of an Acquisition Window) appears on the title bar of the dialog box.

8.2.1 - Supplying calibration details

To manually calibrate a data window, first use the drop-down lists on the Manual X-Calibration dialog box to choose the label and the units you wish to use for the x-axis. The available labels and units are shown here:

X-AXIS LABEL	UNITS
Wavelength	nm, μm , cm^{-1} , eV
Raman Shift	cm^{-1}
Position	μm , mm, cm, $\mu\text{i(nches)}$, in(ches)
Time	ms, secs
Pixel	pixels

Your chosen unit will appear on the top of the right-hand column of the two columns to the left of the Manual X-Calibration dialog box. Another drop-down list allows you to choose a polynomial order for your calibration. The following polynomial options are available:

POLYNOMIAL ORDER	DESCRIPTION
Linear	The linear fit is best for situations where only 2 or 3 spectral features can be identified.
Quadratic	A quadratic polynomial produces the best calibration fit if the known spectral features are located near the centre of the CCD sensor.
Cubic	A cubic polynomial produces the best calibration fit if the known spectral features are evenly distributed across the CCD sensor.

To perform the calibration:

1. Place the cross-hairs on a feature which you know to have a particular x-axis value and click Capture. If you wish to remove a point that you had previously selected, click Delete.
2. The pixel number will appear in the left-hand column. Against it, in the right-hand column, enter a value.
3. Repeat steps 1 & 2 for at least one other point. However, to achieve a good quality calibration you should choose a polynomial order fit commensurate with the spread of known spectral features across your sensor.

8.2.2 - Applying calibration

Two check boxes on the Manual X-Calibration dialog box allow you to choose how the system should act upon the calibration details you have provided. You may select either or both of the following options:

- **Apply Calibration to Current Data:** allows you to change the x-axis calibration on an active data window whose filename (or #0 in the case of an Acquisition Window) appears on the title bar of the Manual X-Calibration dialog box.
- **Apply Calibration to New Acquisitions:** the calibration details you have supplied in the Manual X-Calibration dialog box will be applied to any subsequent data acquisitions.

8.2.3 - Calibrate

Depending on the selections made using the check boxes on the Manual X-Calibration dialog box, clicking the Calibrate button will apply calibration to the active data window and/or to future data acquisitions

8.2.4 - When Manual X-Calibration goes wrong

In the event that Manual X-Calibration fails, it typically does so for one of two reasons:

1. Data that you are attempting to calibrate are non-monotonic, e.g. a wavelength that should correspond to a single pixel value has several pixel values
2. You have identified too few points (i.e. 0 or 1) for the system to perform a calibration. The system displays one or other of the following Error dialog boxes:

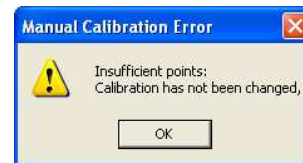
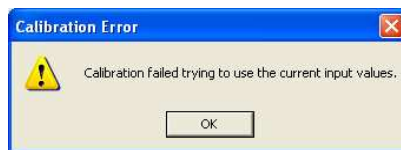

8.2.4.1 - Data are Non-Monotonic

Your data may be Non-Monotonic if you have entered an incorrect value for one or more points on your data trace. An instance of grossly inaccurate manual calibration is shown here:

	953	nm
1	457	546.1
2	690	577
3	706	550
4	953	612
5		
6		
7		
8		
9		
10		

From Pixel 706 to Pixel 953 the user has indicated a fall in wavelength, despite the preceding rise in pixel 690. In such a case, an illegal non-monotonic calibration (as shown on the graph below) results.

The squares indicate points entered by a user, pixel values A, B and C illustrate the non-monotonicity of a sample wavelength of around 570 nm (i.e. three different pixel values for a single wavelength).

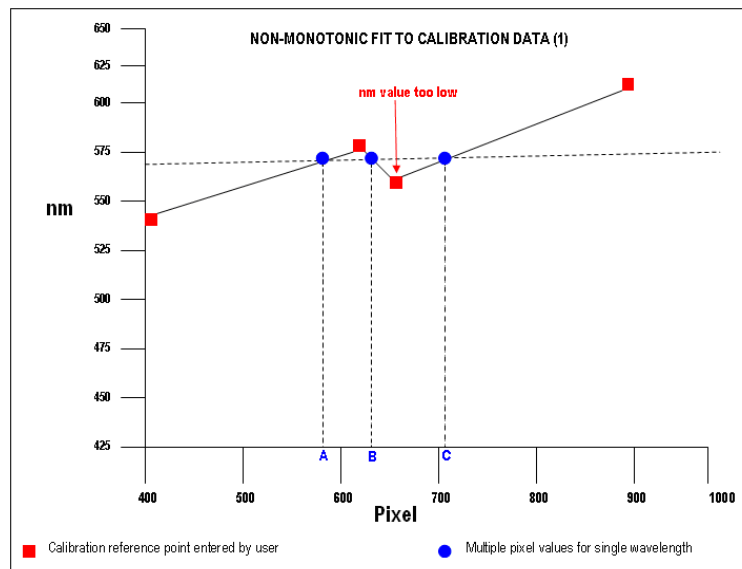

However, a non-monotonic calibration may come about even in cases where your data are not as grossly inaccurate as those shown in the example above. A non-monotonic calibration sometimes results if you attempt to calibrate points that are very close together on your trace, even if, for example, you are entering rising wavelength values against rising pixel values.

In its background processing, the system models the calibration data (the user-supplied reference points) as a cubic polynomial. Inaccurate values mapped to pixels that are close together may cause the system to model the calibration data as shown in the following graph.

Again certain (wavelength) values are non-monotonic relative to pixel value (e.g. see pixel values **A** and **B** below). The squares on the graph indicate points entered by the user, the rightmost point being at slightly too low a wavelength value.

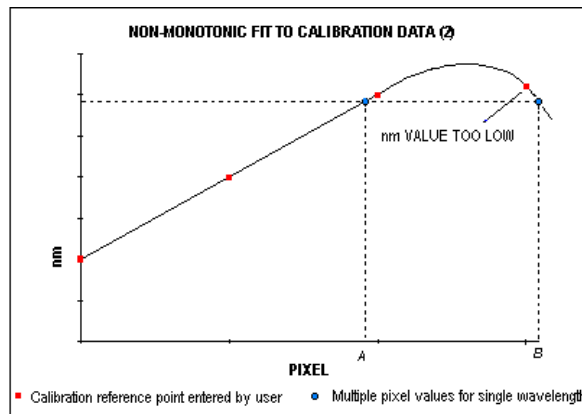

8.2.4.2 - Too few points

A calibration error will also occur if you have entered no data points, or only one data point, in the Manual X-Calibration dialog box. As a general rule, to obtain a good quality calibration, use more than five reference points, at regular intervals, across the full width of the CCD sensor.

8.2.4.3 - Undo

Click the Undo button to exit the Manual X-Calibration dialog box and to undo any calibrations that you have performed since entering the dialog box.

8.2.4.4 - Close

Click the Close button to exit the Manual X-Calibration dialog box.

8.3 - X-CALIBRATION BY SPECTROGRAPH

To calibrate data using the spectrograph, select the **X-Calibration by Spectrograph** option from the **Calibration** Menu. The **Spectrograph X-Calibration** dialog box will appear e.g.:

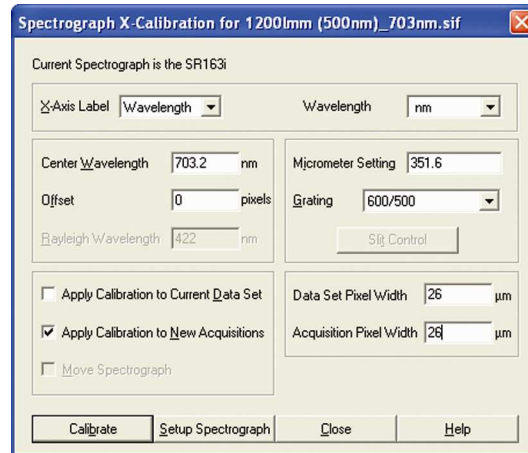

NOTE: This dialog box can also be opened by selecting the **Setup Spectrograph** option from the **Hardware** menu on the main window.

8.3.1 - Setup Spectrograph

Before you can perform a calibration using the spectrograph, you must ensure that the system knows which spectrograph you are using. To select the type of spectrograph to be used, click the **Setup Spectrograph** button on the **Spectrograph X-Calibration** dialog box and the **Setup Spectrograph** dialog box appears, e.g.:

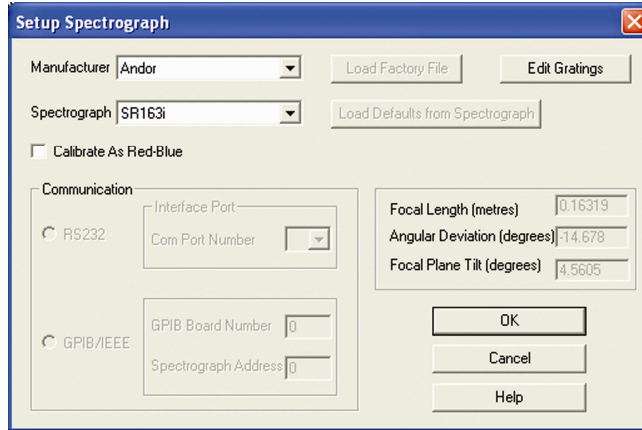

From the Manufacturer drop-down list, select the appropriate company name and from the Spectrograph drop-down list, select the model type being used, then click OK. The Spectrograph X-Calibration will appear again, with the details of the selected spectrograph. With the exception of User Defined, selecting one of these options will cause the system to select and display in grayed (i.e. non-writable - text boxes) the following parameters for your spectrograph:

- **Focal Length (metres)**
- **Angular Deviation (degrees)**
- **Focal Plane Tilt (degrees)**

If you select the User Defined option from the drop-down list, you should consult the manufacturer's handbook for details then key in the values for the spectrograph.

If you are using a motorized spectrograph, the system may be able to load spectrograph attributes (number of gratings, lines/mm, etc.) directly. The Load Defaults from Spectrograph button is enabled if an appropriate motorized spectrograph is chosen from the Spectrograph drop-down list. Depending on the type of spectrograph being used, you can also select the type of interface needed from the **Communication** section of the dialog box.

8.3.1.1 - Calibrate As Red-Blue

Some CCD detectors readout data in the reverse direction to Andor cameras. In this case, the longer wavelengths (red) are to the left (as viewed from the detector), and shorter wavelengths (blue) are to the right.

If you tick the Calibrate As Red-Blue option in the Setup Spectrograph dialog box, the system then uses software to 'reverse' the output of the detector when it generates a data window, thus presenting the display in the more usual orientation.

8.3.2 - Communications

The radio buttons in the Communication section of the Spectrograph Setup Dialog box can be used to establish an interface between your computer and the spectrograph.

If you are using an Andor Shamrock SR303i, select Shamrock Control from the Hardware drop-down menu:

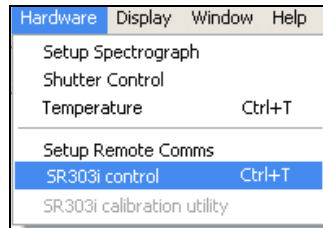

The Shamrock Control dialog box appears e.g.:



Select **CCD** then click OK.

NOTE: When a Shamrock spectrograph is connected, the Shamrock icon  appears in the menu bar of the main window.

In the event of an error in communication occurring, you will be prompted by a message, similar to the following:

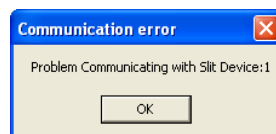

8.3.2.1 - Other spectrographs

If (for example) you have selected an Oriel MS257 spectrograph, you can now **Load Factory File**. This file supplies the system with important configuration details of your particular spectrograph. It must be loaded for the system to control the spectrograph correctly. The Factory File will have been supplied on diskette with your MS257 spectrograph. Performing Load Factory File lets you save the file contents to the .ini file included with Andor's software, after which the Factory File need not be loaded again.

When you click the Load Factory File button you will see a typical Windows 'Open File' dialog box. Select the directory and the filename of the file you wish to load, and click OK. The Factory File is now loaded.

8.3.2.2 - Reverse Spectrum

Some spectrographs produce somewhat “atypical” spectra, where longer wavelengths (red) are to the left (as viewed from the detector), and shorter wavelengths (blue) are to the right. If you select the MS127 or the FICS spectrograph from the drop-down list for example, you will notice a tick in a **Reverse Spectrum** check box. Because both these spectrographs are of this type, the Reverse Spectrum check box is ticked by default when these spectrographs are selected. The system then uses software to ‘reverse’ the output of the detector when it generates a data window, presenting the display in the more usual orientation. You may, if you wish, disable the Reverse Spectrum function by clicking the check box.

8.3.2.3 - X-Axis Labels & Units

The Spectrograph X-Calibration Dialog box allows you to select, from scrollable drop-down list boxes, an X-Axis Label for your data window and an appropriate Unit of measurement. The following label & unit combinations are available:

X-Axis Label	Units
Wavelength	nm, μm , cm^{-1} , eV
Raman Shift	cm^{-1}

8.3.2.4 - Change Units

To change the x-axis units of an active data window which you have previously calibrated, select the **Change Units** option on the Calibrate Menu. The Change X-Calibration of Acquisition dialog box will appear on your screen, e.g.:

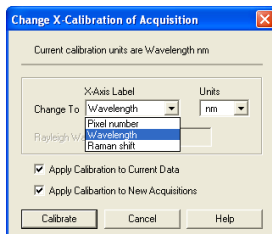

- From the X-Axis Label drop-down list choose whether you want the x-axis to represent Wavelength, Pixel Number or Raman Shift.
- From the Units drop-down list, choose the units that you want to use for your recalibration.

The available combinations depend on how the data were previously calibrated. If for instance, the data were previously calibrated in Wavelength and Nanometers the available combinations for recalibration are:

Wavelength	nm, μm , cm^{-1} , eV
Raman Shift	cm^{-1}
Pixel Number	-

Table 10 below shows the available combinations for all modes.

Table 10: Label & Unit changes

	X-Axis Label	Units	Can Change to
0	User Type	-	
1	Pixel Number (see NOTE 1. below)	-	
2	Wavelength	nm, μm , cm^{-1} , eV	1, 2, 3
3	Raman Shift	cm^{-1}	1, 2
4	Position	μm , mm, cm, $\mu\text{(nches)}$, in(ches)	1, 4
5	Time	ms, s	1, 5
6	Sample	-	1

NOTES:

1. Changing from pixel number actually constitutes a new calibration and can only be performed by using Manual X-Calibration or X-Calibration by Spectrograph.
2. If you choose to recalibrate a data window in pixels, you will not be able to perform any further recalibrations on that window using the Change X-Calibration of Acquisition dialog box. If you save (under its previous filename) data that has been recalibrated in pixels, you will lose any previously saved calibration.

8.3.2.5 - Center Wavelength / Center of Raman Shift

The system allows you to adjust your spectrograph so that light of a chosen Wavelength or a chosen Raman Shift falls on the center of the CCD-chip. These are referred to as the Center Wavelength and the Center of Raman Shift respectively.

- If you have chosen Wavelength as your X-Axis Label, enter the Center Wavelength in the text box provided on the Spectrograph X-Calibration dialog box.
- If you have chosen Raman Shift as your X-Axis Label enter the Center of Raman Shift in the text box.

In each instance, the value is expressed in the units you selected previously above.

If you enter too large or too small a value an Error dialog box appears, e.g.:

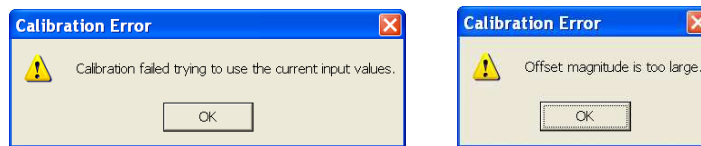

8.3.2.5.1 - Note on Raman Shift

The Raman Shift is calculated as follows:

- If scatter is the wavelength of the Raman scattered light in nanometers and laser is the wavelength of the incident laser light in nanometers, then the Raman Shift in cm⁻¹ (i.e. rs) is calculated as follows:

$$rs = 107 \times [(scatter - laser) / (scatter \times laser)]$$

Thus, if **scatter < laser**, a negative Raman Shift (anti-Stokes transition) will result.

- If **scatter > laser**, a positive Raman Shift (Stokes transition) will result.

Positive and negative values for Raman Shift may thus appear on the x-axis of a data window that is calibrated for Raman Shift, and may be used in the calibration process itself.

8.3.2.6 - Offset

By entering a value in the Offset text box of the Spectrograph X-Calibration dialog box you can compensate for small misalignments of the detector or the wavelength drive in your spectrograph. A positive value will cause the x-axis of the data window to move to the right (relative to the trace) by the corresponding number of pixels. A negative value will cause the x-axis to move to the left.

NOTE: To assess the accuracy of any calibration you have performed, you will need a calibration spectral line source, such as a helium neon laser or a mercury vapor lamp. Ideally, set the spectrograph to one of the prominent spectral lines, take a scan, and use the cursor on the data window to determine any offset (in pixels) of the line from its true wavelength.

8.3.2.7 - Rayleigh Wavelength

If you have selected Raman Shift as your X-Axis Label, you must enter a value in nanometers for the Rayleigh Wavelength. In Raman Spectroscopy the Rayleigh Wavelength is that element of a spectrum line (in scattered radiation) whose wavelength is equal to that of the incident radiation (i.e. the laser wavelength) and is a product of ordinary or Rayleigh scattering.

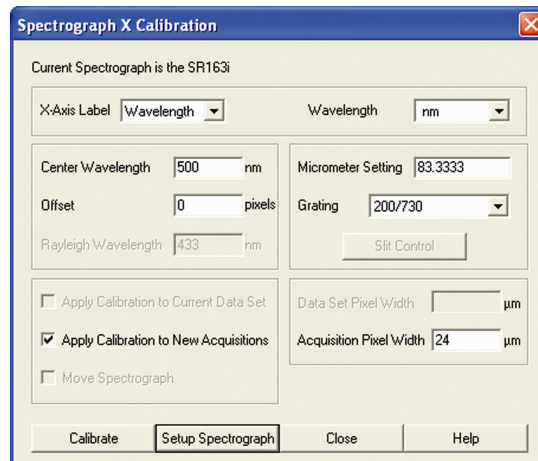

An error message will appear if you attempt to perform a calibration without having entered a valid Rayleigh Wavelength, e.g.:

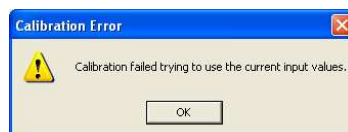

8.3.2.8 - Micrometer Setting

For certain non-motorized spectrographs, the system will calculate a **Micrometer Setting** that corresponds to the Grating and the Center Wavelength/Center of Raman Shift you have chosen. The Micrometer Setting allows you to manually adjust the angle of the diffraction grating (by means of the micrometer on the spectrograph housing), so that light of the wavelength/Raman shift of your choice falls on the centre of the CCD-chip.

The Micrometer Setting appears in a text box on the Spectrograph X-Calibration dialog box. You should use this value to manually set the micrometer on the spectrograph.

NOTE: If you choose to enter a micrometer setting, the system will calculate a value for the Center Wavelength/Center of Raman Shift and vice versa. You need enter only one of the two values.

Because Raman shift does not correlate linearly with wavelength (or pixel positions), the center column of pixels on the CCD-chip (e.g. column 512 on a chip of 1024 pixels) is likely to be represented off-center on the x-axis of a data window linearly calibrated for Raman shift. Column and where appropriate, row number, are expressed in the form [x,y] on the status bar along the bottom edge of the data window.

NOTES:

- 1. If you choose Raman Shift as the X-Axis label, the Center Wavelength text box is relabeled Center of Raman Shift.**
- 2. In the case of motorized spectrographs, the wavelength drive is under direct software control.**

8.3.2.9 - Grating

From the scrollable drop-down list select the specification of the diffraction grating you are currently using. Grating specifications are shown as a line density followed by (where applicable) a blaze wavelength.

8.3.2.10 - Close

To exit the Spectrograph X-Calibration dialog box, click Close.

NOTE: The details you supply regarding your spectrograph, including any retrieved data, will subsequently appear by default whenever you open the Spectrograph X-Calibration dialog box. You can change them whenever you choose.

8.4 - PROCESSING DATA VIA THE COMMAND LINE

8.4.1 - Command Line

The Command Line allows you to enter one-line commands that are written in the Andor Basic programming language. These commands are used to manipulate acquired data. Several command lines can be entered and they are separated by ‘:’.

To open the Command Line dialog box, either click the  button or select the Command Line option from the Command drop-down menu. The dialog box opens as per the following example:

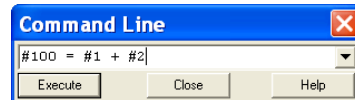

To run a command, click **Execute**. For further details of how to use the Andor Basic programming language, please refer to the User's Guide to Andor Basic.

8.4.2 - Calculations

The Calculations option lets you display the output of colorimetry calculations in a CIE Calculations Window.

8.4.3 - Configure calculations

The Configure Calculations option lets you choose which colorimetry calculations you are going to perform and which parameters you are going to use.

For further information, please refer to **Colorimetry Calculations** in the **Andor Radiometry Guide**.

SECTION 9 - WORKING WITH PROGRAMS

9.1 - Working with Andor BASIC Programs

The Andor Basic programming language allows you to create programs for customized control of data acquisition and customized manipulation of data. Please refer to the **Programmer's Guide to Andor Basic**.

The system provides facilities to let you Edit, Save and Run your programs.

9.1.1 - Command Line

The Command Line gives you ready access to all functions and arithmetic data processing of the Andor Basic programming language, without the need to write programs. However, to process the contents of a data set, the data set must first be in memory (RAM), and a corresponding Data Window will therefore be on screen.

To open the Command Line, click the  button.

As an example, the following entry on the command line adds together the data in the data sets #1 and #2, and stores the result in a third, possibly new, data set labeled #100. Thus $\#100 = \#1 + \#2$:

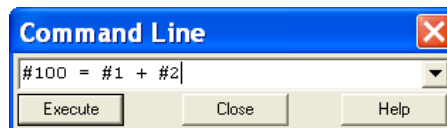

9.1.2 - Program Editor window

Opening a program file, or selecting New Program from the File Menu launches a Program Editor Window where you can enter unformatted text.





While you are working in the Program Editor Window, context sensitive help is available on the 'reserved words' of the programming language. With the cursor on or immediately after a reserved word, press **Ctrl + F1**.

9.1.3 - Accessing the Edit functions

Edit facilities are available either as edit buttons on the Main Window or as options on the Edit and Save Menus.

Some options (Cut, Copy) become available only when you have highlighted a segment of text. Others are available only when preceded by another operation (Paste must be preceded by Cut or Copy).

9.1.4 - Cut, Copy, Paste, Undo

- Cut  or Copy  text that you have highlighted, then paste the text into a new position
- Paste  inserts cut or copied text into the position following the cursor, or replaces text that you have highlighted
- Undo  causes the text to revert to its state before the last change was made

9.1.5 - Search

To search for items, either click on the Find  button on the Program Window or select Find... from the Search drop-down menu:



The Find dialog box appears:

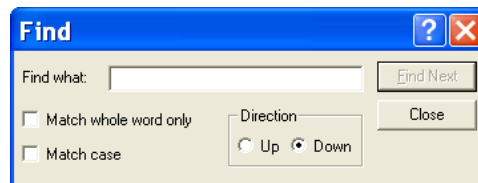

In the Find what text box, type the word or phrase (the 'search string') that you want to find.

Select Match whole word only to look for a complete word or for the same combination of capital and/or small letters as occur in the search string, select Match case.

Select Direction to determine in which way the search will be carried out.

To activate the search, click on Find Next or click the  button.

9.1.6 - Replace

To replace items, select **Replace...** from the **Search** drop-down menu:

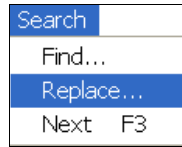

In the **Find what** text box, type in the search string and in the **Replace with** text box, type the word or phrase that you want to use instead, e.g.:

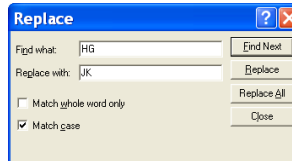

- Click **Replace** to change the next occurrence of the search string (or the highlighted search string if you have just used Find Next).
- Click **Replace All** to replace the search string wherever it occurs after the current cursor position.
- Check boxes let you Match whole word only or Match case.

9.1.7- Run Program

To run a program, first ensure sure you have opened the appropriate **.pgm** file and ensure that the filename appears in the drop-down list box.

Secondly either click the  button or select **Run Program** from the **File** drop-down menu:

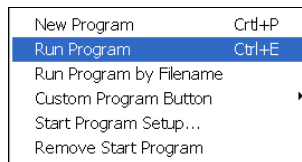

The program will now start. To change the name of the file you want to run, carry out one of the following actions:

- Open the drop-down list and click the name of the file
- Select an open Program Editor Window
- Open the .pgm file from the File menu

9.1.8 - Run Program by Filename

You may also run a program by means of the Run Program by Filename option on the File Menu.

Select **Run Program by Filename** from the File drop-down menu:

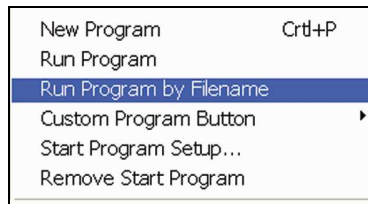

A standard Open dialog box appears, from which you may select the file whose contents you want to run. The file containing the program appears on screen as an iconized Program Editor Window and the program begins to execute immediately.

9.1.9 - Entering program input



Any text-based input required by the program (i.e. in Andor Basic you have indicated that the user must manually enter a value at a particular point in the program's execution) is entered via an Input dialog box.

SECTION 10 - TUTORIAL**10.1 - CALIBRATING DATA USING FLUORESCENT ROOM LIGHT****10.1.1 - Aim & requirements**

The object of this experiment is to let you learn to use the CCD by applying a wavelength calibration using a typical fluorescent room light as a source. You will need the following items:

- CCD
- Fluorescent room light
- Spectrograph

10.1.2 - Description

1. Attach the detector to the spectrograph. Ensure that the spectrograph has been fitted with a suitable diffraction grating (e.g. 600 l/mm) and that the spectrograph's micrometer (when using a manual spectrograph) has been set for a center wavelength of about 500 nm, i.e. in the middle of the visible range. For a 600 l/mm grating and center wavelength 500 nm the micrometer setting will be 250.
2. To remove dark signal, you should acquire data as background corrected counts. To select background corrected counts as your data type, open **the Acquisition Menu** on the Main Window and select the option **Setup Data Type**. On the Data Type dialog box click the **Counts (Bg - corrected)** radio button and close the Data Type dialog box by clicking the **OK** button.
3. You are now ready to acquire data. Acquire the background data first. To ensure that the background is acquired in darkness, cover the input slit of the spectrograph (if you have no shutter) and from the **Acquisition Menu** on the **Main Window** select the option **Take Background**. Background data are displayed on-screen under the **Bg** tab of an Acquisition Window. Uncover the input slit of the spectrograph.
4. Now acquire the signal data. These data will automatically be background corrected. Point the spectrograph's input slit at a fluorescent room light.
5. From the Acquisition Menu on the Main Window select the option **Take Signal** (alternatively, click the  button). By default the system will acquire signal data in Real Time mode, i.e. it will repeatedly acquire and display data until you press the **Esc** key or click the  button on the Main Window.

- Signal data are displayed on-screen under the **Sig** tab of an Acquisition Window. If the signal appears weak (i.e. the signal data are at low numbers of counts on the data-axis) or if the CCD is saturating (there are 'plateaus' on the trace at the top of the data-axis) try repositioning the spectrograph relative to the light in order to change the light level. The system's default exposure time of 25ms should be adequate for acquiring data from typical room lighting.
- When you are happy with the signal strength, press the **Esc** key or click the  button on the Main Window to stop acquiring data.
- Now calibrate these signal data. Use manual calibration so that you can identify and place wavelength values against features of the data trace. A typical data trace for a fluorescent room light is shown below (wavelength in nm is marked against the main features):

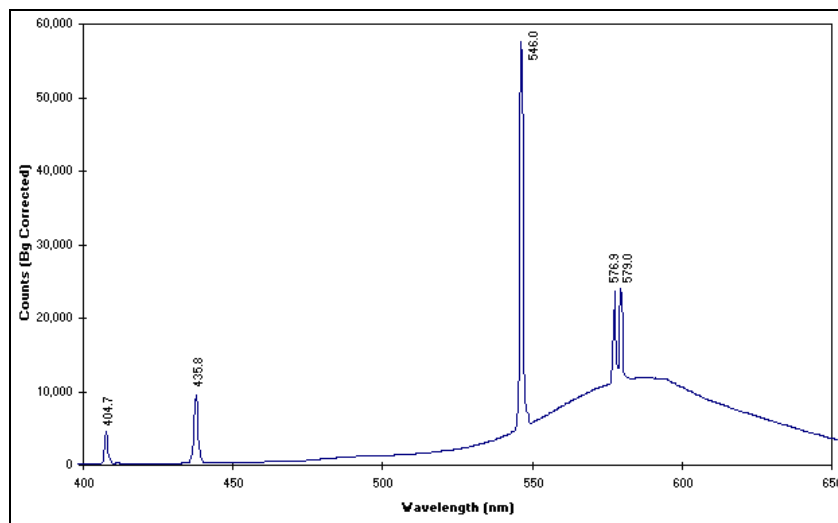

9. From the **Calibrate** menu select **Manual X-Calibration** and make the following entries:
 - Set **X-Axis Label Wavelength** entry in the **Units** list box to **nm**
 - **Apply Calibration to Current Data** checkbox is ticked.

NOTE: The data range and relative intensities will vary with operating conditions and specification of equipment used.

10. Click the trace in the Acquisition Window at one of the points that you recognize as having a particular value (you may have to use the left and right arrow keys to 'fine tune' the cursor location to a peak). It is best to use peaks that are reasonably well separated when you perform a calibration. Attempting to calibrate both peaks of the yellow doublet is not recommended, for example. Click the **Capture** button on the **X-Calibration** dialog box. A pixel number (the x-axis co-ordinate of the point you selected on the trace) now appears in the two-column spreadsheet of the **Manual X-Calibration** dialog box. Beside the pixel number enter the wavelength that corresponds to the feature on the trace. Repeat this process for several other features on the trace then click the Calibrate button.
11. If you have identified one or more of the points on the trace incorrectly, so that the scale on the x-axis (if calibration were attempted) would not be monotonic, an error dialog box will warn you that the calibration of your trace has not been changed. Close the error dialog box by clicking the OK button.
12. On the **Manual X-Calibration** dialog box, re-examine the values you have entered. You may click the Delete button to remove any point you no longer wish to use for calibration, or you may overwrite a value that you previously entered with a new value. Click the **Calibrate** button again.
13. If you have selected and labeled the points on the trace accurately, the data in the Acquisition Window will now be calibrated in nm.

SECTION 11 - APPENDIX**A1.1 - GLOSSARY**

If this is the first time you have used Andor's CCD, the glossary that follows will help familiarize you with its design philosophy and some of its key terminology.

A1.1.1 - CCD

A **Charge Coupled Device** (or **CCD**) is a silicon-based semiconductor chip bearing a two-dimensional matrix of photo-sensors, or pixels. This matrix is usually referred to as the image area. The pixels are often described as being arranged in rows and columns (rows running horizontally, columns vertically). A typical CCD-chip may comprise 256 rows and 1024 columns, or 578 rows and 385 columns.

The CCD in your detector is a scientific slow scan device (in contrast to the fast scan CCD used in video cameras to capture moving images). An example of a typical layout is shown here:

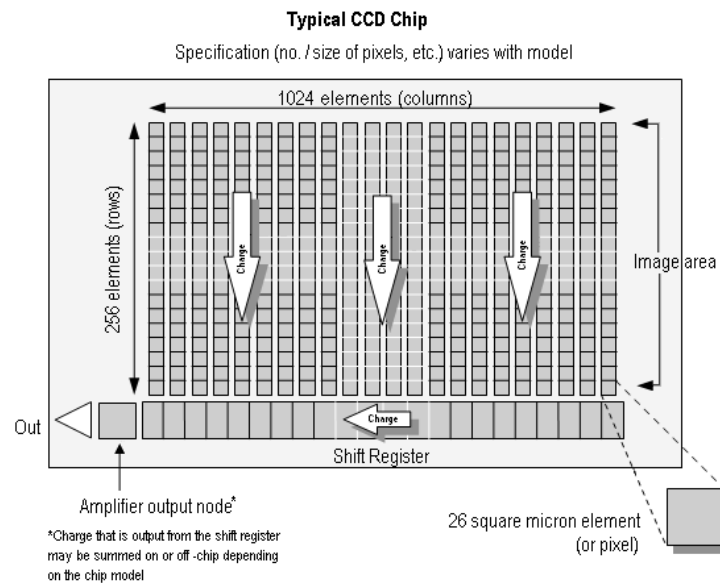

The shift register runs below and parallel to the light collecting rows. It has the same number of pixels as a light-collecting row, but is itself masked, so that no light can fall on it.

When light falls on an element, electrons (photoelectrons) are produced and (in normal operation), these electrons are confined to their respective elements. Thus, if an image (or any light pattern) is projected on to the array, a corresponding charge pattern will be produced. To capture the image pattern into computer memory, the charge pattern must be transferred off the chip, and this is accomplished by making use of a series of horizontal (i.e. parallel to the rows/shift register) transparent electrodes that cover the array. By suitable 'clocking', these electrodes can be used to shift (transfer) the entire charge pattern, one row at a time, down into the shift register.

The shift register also has a series of electrodes (they are vertical, i.e. parallel to the columns) which are used to transfer the charge packets, one element at a time, into the output node of the 'on-chip' amplifier.

The output of the amplifier feeds the analog-to-digital (A/D) converter, which in turn converts each charge packet into a 16-bit binary number.

A1.1.1.1 - Readout sequence of a CCD

In the course of readout, charge is moved vertically into the shift register, and then horizontally from the shift register into the output node of the amplifier. The readout sequence illustrated below (which corresponds to the default setting of the Full Resolution Image binning pattern) allows data to be recorded for each individual element on the CCD-chip. Other binning patterns are achieved by summing charge in the shift register and/or the output node prior to readout (see **Vertical Binning and Horizontal Binning** on pages 153 & 154 respectively).

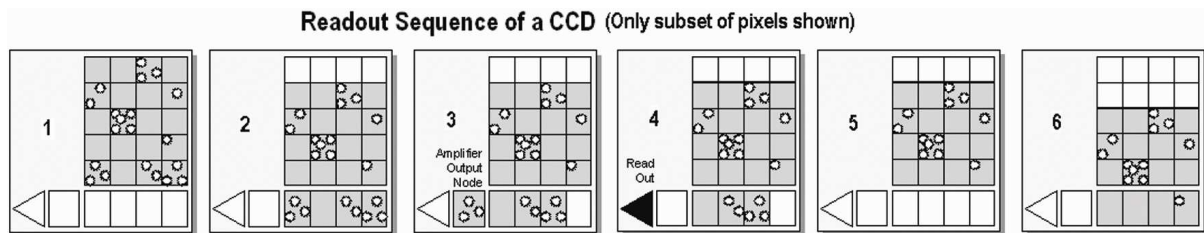

- 1 Exposure to light causes a pattern of charge (an electronic image) to build up on the frame (or 'image area') of the CCD-chip.
- 2 Charge in the frame is shifted vertically by one row, so that the bottom row of charge moves into the shift register.
- 3 Charge in the shift register is moved horizontally by one pixel, so that charge on the endmost pixel of the shift register is moved into the output node of the amplifier.
- 4 The charge in the output node of the amplifier is passed to the analog-to-digital converter and is read out.
- 5 **Steps 3 & 4** are repeated until the shift register is emptied of charge.
- 6 The frame is shifted vertically again, so that the next row of charge moves down into the shift register. The process is repeated from **Step 3** until the whole frame is read out.

A1.1.2 - Accumulation

Accumulation is the process by which data that have been acquired from a number of similar scans are added together in computer memory. This results in improved signal to noise ratio.

A1.1.3 - Acquisition

An Acquisition is taken to be the complete data capture process.

A1.1.4 - A/D conversion

Charge from the CCD is initially read as an analog signal, ranging from zero to the saturation value. **A/D** (Analog to **D**igital) conversion changes the analog signal to a binary number which can then be manipulated by the computer.

A1.1.5 - Background

Background is a data acquisition made in darkness. It is made up of fixed pattern noise, and any signal due to dark current.

A1.1.6 - Binning

Binning is a process that allows charge from two or more pixels to be combined on the CCD-chip prior to readout (see **Readout Sequence of a CCD on page 151**).

Summing charge on the CCD and doing a single readout results in better noise performance than reading out several pixels and then summing them in the computer memory. This is because each act of reading out contributes to noise (see **page 157**).

The two main variants of the binning process are **Vertical binning** and **Horizontal binning**, which are individually described in the pages that follow. In addition there are several binning patterns that tailor the main binning variants to typical application usage.

A1.1.6.1 - Vertical Binning

In Vertical Binning, charge from two or more rows of the CCD-chip is moved down into the shift register before the charge is read out. The number of rows shifted depends on the binning pattern you have selected. Thus, for each column of the CCD-chip, charge from two or more vertical elements is 'summed' into the corresponding element of the shift register. The charge from each of the pixels in the shift register is then shifted horizontally to the output node of the amplifier and read out.

Variants of Vertical Binning are used to affect a variety of binning patterns and they are as follows:

- **Single-Track:** charge is vertically binned and read out from a number of complete, adjacent rows of pixels on the CCD-chip. The rows form a single track across the full width of the CCD-chip. A value is taken for each column in the track.
- **Multi-Track:** Multi-Track mode differs from Single-Track in that you may now define two or more tracks from which to read out charge. In processing terms, each track is treated as in Single-Track above.
- **Full Vertical Binning (FVB):** charge from each complete column of pixels on the CCD is moved down and summed into the shift register and the charge is then shifted horizontally one pixel at a time from the shift register into the output node. In effect a value is read out for each complete column of the CCD-chip.

The example below illustrates readout of data from adjacent tracks, each track comprising two binned rows of the CCD-chip:

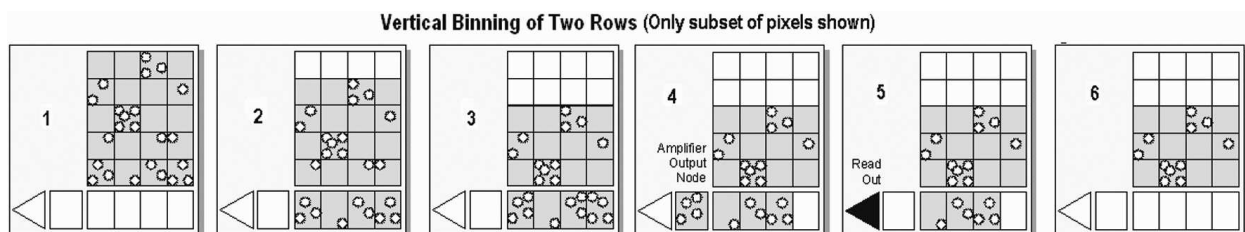

- 1 Exposure to light causes a pattern of charge (an electronic image) to build up on the frame (or 'image area') of the CCD-chip.
- 2 Charge in the frame is shifted vertically by one row, so that the bottom row of charge moves down into the shift register.
- 3 Charge in the frame is shifted vertically by a further row, so that the next row of charge moves down into the shift register, which now contains charge from two rows - i.e. the charge is vertically binned.
- 4 Charge in the shift register is moved horizontally by one pixel, so that charge on the endmost pixel of the shift register is moved into the output node of the amplifier.
- 5 The charge in the output node of the amplifier is passed to the analog-to-digital converter and is read out.
- 6 Steps 4 and 5 are repeated until the shift register is empty. The process is repeated from **Step 2** until the whole frame is read out.

A1.1.6.2 - Horizontal Binning (Creating Superpixels)

Shifting the charge horizontally from several pixels at a time into the output node is known as horizontal binning. Horizontal binning in combination with vertical binning allows you to define so-called superpixels that in Image Display Mode represent as a single picture element charge that has been binned from a group of pixels.

For example, charge that is binned vertically from two rows and horizontally from two pixels before being read out is displayed as a superpixel of dimensions 2 x 2 pixels.

On the one hand, superpixels (by comparison with single pixels) result in a more coarsely defined image when the data are displayed in Image Display Mode; on the other hand, superpixels offer the advantages of summing data on-chip prior to readout.

In the example below (where each superpixel is of dimensions 2x2 pixels) charge from two rows is first binned vertically into the shift register; then charge from two pixels of the shift register is binned horizontally into the output node of the amplifier. The effect of the combined binning processes is a summed charge equating to a 2x2 “superpixel”.

Since this example initially involves binning charge from two rows, the process begins in the same way as the example on the previous page (Steps 1 - 4 of Vertical Binning of Two Rows), then horizontal binning begins.

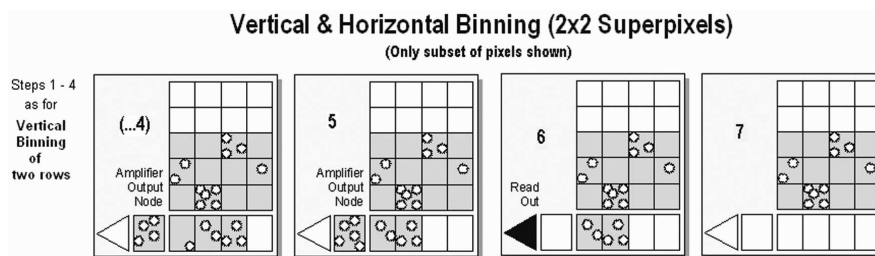

- (...4) Charge from two rows has already been vertically binned into the shift register (see **Vertical Binning** on **page 153**). Now charge in the shift register is moved horizontally by one pixel, so that charge on the endmost pixel of the shift register is moved into the output node of the amplifier.)
- 5 Charge in the shift register is again moved horizontally, so that the output node of the amplifier now contains charge from two pixels of the shift register - i.e. the charge has been horizontally binned.
- 6 The charge in the output node of the amplifier is passed to the analog-to-digital converter and is read out.
- 7 **Steps 4 - 6** are repeated until the shift register is empty. The process is repeated from **Step 2** (again, please refer to **Vertical Binning** on **page 153**) until the whole frame is read out.

A1.1.7 - Counts

Counts refer to the digitization by the A/D conversion and are the basic unit in which data are displayed and processed. Depending on the particular version of the detection device, one count may, for example, be equated with a charge of 10 photoelectrons on a pixel of the CCD.

A1.1.8 - Dark Signal

Dark signal, a charge usually expressed as a number of electrons, is produced by the flow of dark current during the exposure time. All CCD's produce a dark current, an actual current that is measurable in (typically tenths of) milliamps per pixel.

The dark signal adds to your measured signal level, and increases the amount of noise in the measured signal. Since the dark signal varies with temperature, it can cause background values to increase over time. It also sets a limit on the useful exposure time.

Reducing the temperature of the CCD reduces dark signal (typically, for every 7°C that temperature falls, dark signal halves). CCD readout noise is low, and so as not to compromise this by shot noise from the dark signal, it is important to cool the detector to reduce the dark signal. If you are using an exposure time of less than a few seconds, cooling the detector below 0°C will generally remove most of the shot noise caused by dark signal.

A1.1.9 - Detection Limit

The Detection Limit is a measure of the smallest signal that can be detected in a single readout. The smallest signal is defined as the signal whose level is equal to the noise accompanying that signal, i.e. a signal to noise ratio (S/N) of unity. The main sources of noise are as follows:

- Shot noise of the signal itself
- Shot noise of any dark signal
- Readout noise

If the signal is small, we can ignore its shot noise.

Furthermore, if a suitably low operating temperature and short exposure time can be achieved, the lowest detection limit will equal the readout noise.

A1.1.10 - Exposure Time

The Exposure Time is the period during which the CCD collects light prior to readout.

A1.1.11 - Frame Transfer

Frame transfer is a mode of operation of the chip. It can be switched on for any acquisition mode. It is only available if your system contains a Frame Transfer CCD (FT CCD), which differs from a standard CCD in the following 2 ways:

Firstly, a FT CCD contains 2 areas, of approximately equal size (see **figure 10** below):

1. The first area is the Image area, this area is at the top and farthest from the read-out register. It is in this area that the CCD is sensitive to light.
2. The second area is the Storage area and sits between the Image area and the read-out register. This area is covered by an opaque mask, usually a metal film, and hence is not sensitive to light.

The second way in which a FT CCD differs from a standard CCD is that the Image and the Storage areas can be shifted independently of each other.

These differences allow a FT CCD to be operated in a unique mode where one image can be read out while the next image is being acquired. It also allows a FT CCD to be used in imaging mode without a shutter.

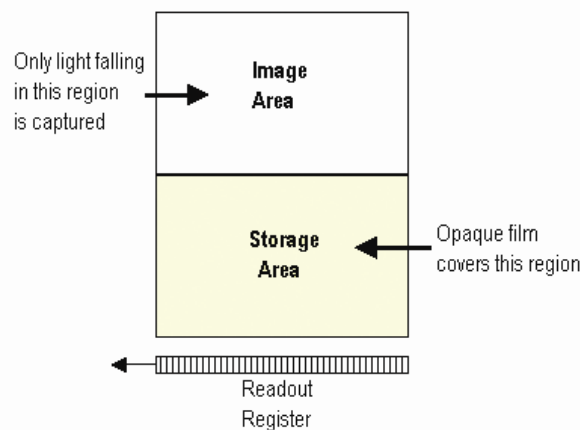

Figure 10: Frame Transfer CCD

A1.1.12 - Noise

Noise is a complex topic, the full exploration of which is beyond the scope of this glossary. Noise may, however, be broken down into two broad categories:

- Pixel Noise
- Fixed Pattern Noise

These two categories are described in the paragraphs that follow.

A1.1.12.1 - Pixel noise

Let us first attempt to define pixel noise. Assume that a light signal is falling on a pixel of the CCD. If the charge on the pixel is read, and the read process is repeated many times, the noise may be taken as the variation in the values read. The Root Mean Square (r.m.s.) of these variations is often used to express a value for noise. As a rule of thumb, the r.m.s. is four to six times smaller than the peak to peak variations in the count values read from the pixel. Pixel noise has three main constituents as follows:

- Readout noise
- Shot noise from the dark signal
- Shot noise from the light signal itself

Shot noise cannot be removed because it is due to basic physical laws. Most simply defined, shot noise is the square root of the signal (or dark signal) measured in electrons.

A1.1.12.2 - Fixed Pattern noise

Fixed Pattern Noise (FPN) consists of the differences in count values read out from individual pixels, even if no light is falling on the detector. These differences remain constant from read to read. The differences are due in part to a variation in the dark signal produced by each pixel, and in part to small irregularities that arise during the fabrication of the CCD. Since fixed pattern noise is partly due to dark signal, it will change if the temperature changes, but because it is fixed, it can be completely removed from a measurement by background subtraction.

A1.1.12.3 - Readout noise

Readout noise (which in our detectors is, in any case, low) is due to the amplifier and electronics: it is independent of dark signal and signal levels; it is only very slightly dependent on temperature; and it is present on every read, as a result of which it sets a limit on the best achievable noise performance.

Shot noise from the dark signal is dependent on the exposure time and is very dependent on the temperature; shot noise from the signal is additionally dependent on the signal level itself. If either the signal or the dark signal falls to zero, their respective shot noise also falls to zero.

The total pixel noise is not, however, simply the sum of the three main noise components (readout noise, shot noise from the dark signal, and shot noise from the signal). Rather the **Root Sum Square (r.s.s.)** gives a reasonable approximation - thus: **total = sqrt (readnoise² + darkshot² + sigshot²)** where:

- **total** is the pixel noise
- **readnoise** is the readout noise
- **darkshot** is the shot noise of the dark signal
- **sigshot** is the shot noise of the signal

A1.1.13 - Quantum Efficiency / Spectral Response

The glossary refers to signals as a number of electrons. More strictly speaking these are 'photoelectrons', created when a photon is absorbed. When a UV or visible photon is absorbed by the detector it can at best produce only one photoelectron. Photons of different wavelengths have different probabilities of producing a photoelectron and this probability is usually expressed as **Quantum Efficiency (QE)** or '**Spectral Response**'.

QE is a percentage measure of the probability of a single photon producing a photoelectron, while spectral response is the number of electrons that will be produced per unit photon energy. Many factors contribute to the QE of a CCD, but the most significant factor is the absorption coefficient of the silicon that serves as the bulk material of the device

A1.1.14 - Readout

Readout is the process by which data are taken from the pixels of the CCD and stored in computer memory. The pixels, which are arranged in a single row, are read out individually in sequence. Readout involves amplifying the charge on each pixel into a voltage, performing an A/D conversion, and storing the data in computer memory. The time taken to perform this operation is known as the 'read time'.

A1.1.15 - Saturation

Saturation is the largest signal the CCD can measure. A signal is measured in terms of the amount of charge that has built up in the individual pixels on the CCD-chip. A number of factors determine the maximum amount of charge that the CCD can handle.

A1.1.16 - Scan Types: Keep Clean & Acquired

The CCD is continually being 'scanned' to prevent its becoming saturated with dark current (see **Dark Signal** on **page 155**). If the Scan is being used simply to 'clean' the CCD (i.e. it is a keep-clean scan), the charge from the CCD is discarded.

In an acquired scan, however, the charge undergoes A/D conversion and is acquired into computer memory so that it can be used for subsequent processing and display, i.e. it is "read out" (see **Readout** above). In this User's Guide 'scan' generally refers to an acquired scan, unless the context specifically indicates otherwise.

A1.1.17 - Shift Register

The Shift Register usually consists of a single row of elements (or pixels) running parallel to and below the bottom row of light-gathering pixels (the image area) on the CCD-chip. The shift register is protected from light by an aluminum mask. The elements in the shift register have a greater capacity to store charge (a greater 'well depth') than the other pixels on the CCD-chip.

A1.1.18 - Shot noise

Shot Noise is due to basic physical laws and cannot be removed. Any signal, whether it is a dark signal or a light signal, will have shot noise associated with it. This is most simply defined as follows:

If the signal or dark signal = N electrons, the shot noise is the square root of N

You can do nothing about the shot noise of your signal, but by choosing minimum exposures and operating the CCD at suitably low temperatures, the dark signal, and hence the noise from the dark signal, can be reduced.

A1.1.19 - Signal to Noise Ratio

The **Signal to Noise Ratio** (more commonly abbreviated as **S/N** or **SNR**) is the ratio between a given signal and the noise associated with that signal. Noise has a fixed component, and a variable component (shot noise) which is the square root of the signal. Thus, the SNR usually increases (improves) as the signal increases.

The maximum SNR is the ratio between the maximum signal (i.e. the saturation level) and the noise associated with that signal. At near saturation levels the dominant source of noise is the shot noise of the signal.

A1.2 - ELECTRICAL RATINGS & ENVIRONMENTAL CONDITIONS

- Indoor use only
- Altitudes up to 2000m
- Temperature 5°C to 40°C
- Maximum Relative Humidity: 80% for temperatures up to 31°C, decreasing linearly to 50% relative humidity at 40°C
- Other voltage fluctuations as stated by the manufacturer
- Overvoltage category 1
- Pollution Degree 2

A1.3 - ADDITIONAL STATEMENT REGARDING EQUIPMENT OPERATION

IF THE EQUIPMENT IS USED IN A MANNER NOT SPECIFIED BY ANDOR TECHNOLOGY PLC, THE PROTECTION PROVIDED BY THE EQUIPMENT MAY BE IMPAIRED.

A1.4 - MECHANICAL DIMENSIONS

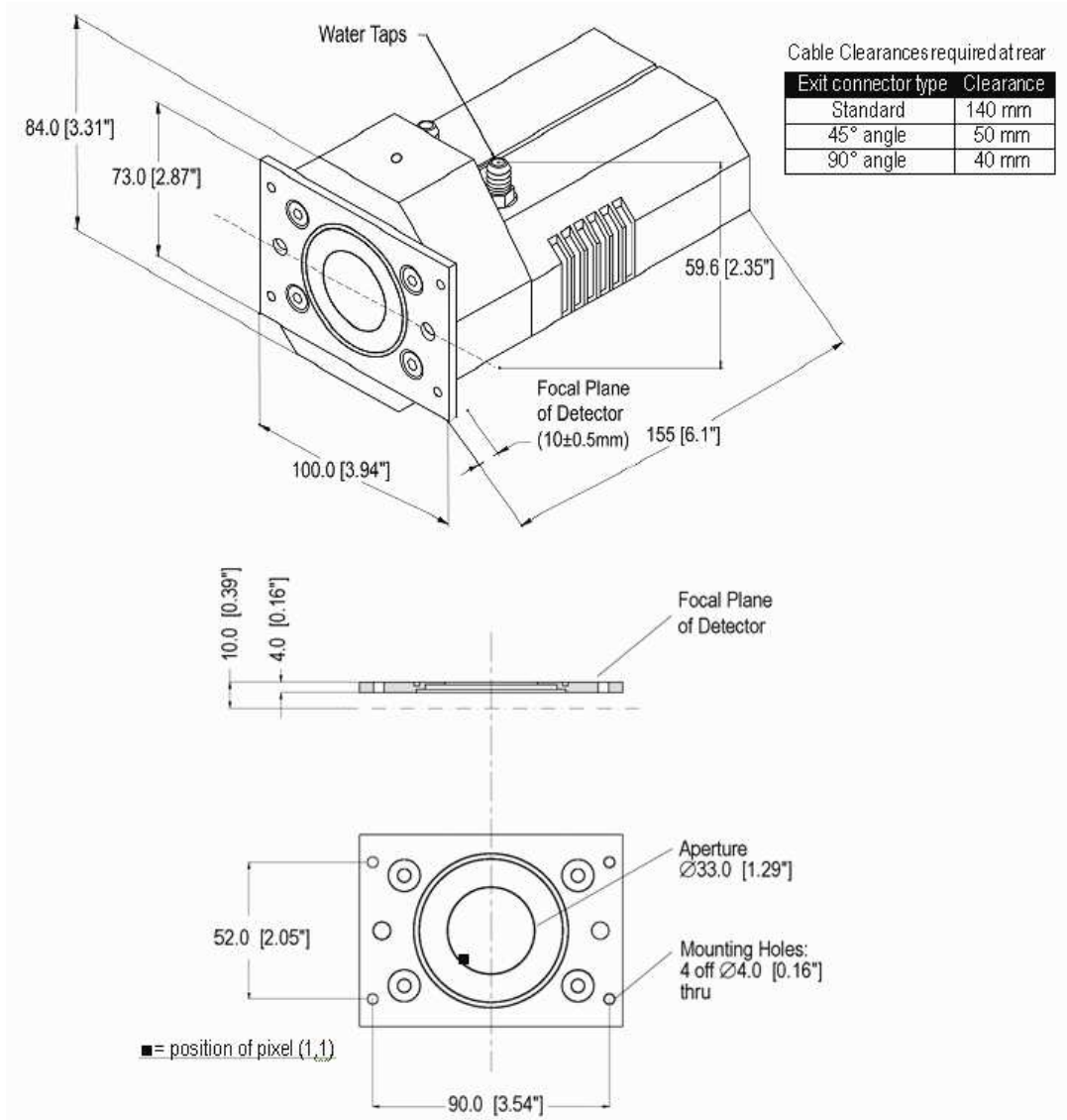

A1.5 - TERMS & CONDITIONS

In these Conditions:

'BUYER' means the person who accepts a quotation of the Seller for the sale of the Goods or whose order for the Goods is accepted by the Seller.

'GOODS' means the goods (including any instalment of the goods or any parts for them) which the Seller is to supply in accordance with these Conditions.

'SELLER' means Andor Technology plc.

'CONDITIONS' means the standard terms and conditions of sale set out in this document and (unless the context otherwise requires) includes any special terms and conditions agreed in writing between the Buyer and Seller.

'CONTRACT' means the contract for the purchase and sale of the Goods.

'WRITING' includes telex, cable, facsimile transmission and comparable means of communication.

2. Any reference in these Conditions to any provision of a statute shall be construed as a reference to that provision as amended, re-enacted or extended at the relevant time.

3. The headings in these Conditions are for convenience only and shall not affect their interpretation.

A1.6 - WARRANTIES & LIABILITY

1. Subject to these Conditions set out below, the Seller warrants that the Goods will correspond with their specification at the time of delivery and will be free from defects in material and workmanship for a period of 12 months from the date of delivery.
2. The above warranty is given by the Seller subject to the following conditions:
 - 2.1 the Seller shall be under no liability in respect of any defect in the Goods arising from any drawing, design or specifications supplied by the Buyer;
 - 2.2 the Seller shall be under no liability in respect of any defect arising from fair wear and tear, wilful damage, negligence, abnormal working conditions, failure to follow the Seller's instructions (whether oral or in writing), misuse or alteration or repair of the Goods without the Seller's approval;
 - 2.3 the Seller shall be under no liability under the above warranty (or other warranty, condition or guarantee) if the total price for the Goods has not been paid by the due date for payment;
 - 2.4 the above warranty does not extend to parts, material or equipment not manufactured by the Seller, in respect of which the Buyer shall only be entitled to the benefit of any such warranty or guarantee as is given by the manufacturer to the Seller.
3. Subject as expressly provided in these conditions, and except where the Goods are sold to a person dealing as a consumer (within the meaning of the Unfair Contract Terms Act 1977), all warranties, conditions or other terms implied by statute or common law are excluded to the fullest extent permitted by law.
4. Any claim by the Buyer which is based on any defect in the quality or condition of the Goods or their failure to correspond with specification shall (whether or not delivery is refused by the Buyer) be notified in Writing to the Seller within 7 days from the date of delivery or (where the defect or failure was not apparent on reasonable inspection) discovery of the defect or failure. If delivery is not refused, and the Buyer does not notify the Seller accordingly, the Buyer shall not be entitled to reject the Goods and the Seller shall have no liability for such defect or failure, and the Buyer shall be bound to pay the price as if the Goods had been delivered in accordance with the Contract. In no event shall the Buyer be entitled to reject the Goods on the basis of any defect or failure which is so slight that it would be unreasonable for him to reject them.
5. Where any valid claim in respect of the Goods which is based on any defect in the quality or condition of the Goods or their failure to meet specification is notified to the Seller in accordance with these Conditions, the Seller shall be entitled to replace the Goods (or the part in question) free of charge or, at the Seller's sole discretion, refund to the Buyer the price of the Goods (or a proportionate part of the price), but the Seller shall have no further liability to the Buyer.

6. Except in respect of death or personal injury caused by the Seller's negligence, the Seller shall not be liable to the Buyer by reason of any representation (unless fraudulent), or any implied warranty, condition or other term, or any duty at common law, or under the express terms of the Contract, for any indirect, special or consequential loss or damage (whether for loss of profit or otherwise), costs, expenses or other claims for compensation whatsoever (whether caused by the negligence of the Seller, its employees or against otherwise) which arise out of or in connection with the supply of the Goods, or their use or resale by the Buyer and the entire liability of the Seller under or in connection with the Contract shall not exceed the price of the goods, except as expressly provided in these Conditions.

7. The Seller shall not be liable to the Buyer or be deemed to be in breach of the Contract by reason of any delay in performing, or any failure to perform, any of the Seller's obligations in relation to the goods, if the delay or failure was due to any cause beyond the Seller's reasonable control. Without prejudice to the generality of the foregoing, the following shall be regarded as causes beyond the Seller's reasonable control:

7.1 Act of God, explosion, flood, tempest, fire or accident;

7.2 war or threat of war, sabotage, insurrection, civil disturbance or requisition;

7.3 acts, restrictions, regulations, bye-laws, prohibitions or measures of any kind on the part of any governmental, parliamentary or local authority;

7.4 import or export regulations or embargoes;

7.5 strikes, lock-outs or other industrial actions or trade disputes (whether involving employees of the Seller or of third party);

7.6 difficulties in obtaining raw materials, labour, fuel, parts or machinery;

7.7 power failure or breakdown in machinery.