

Hardware Guide

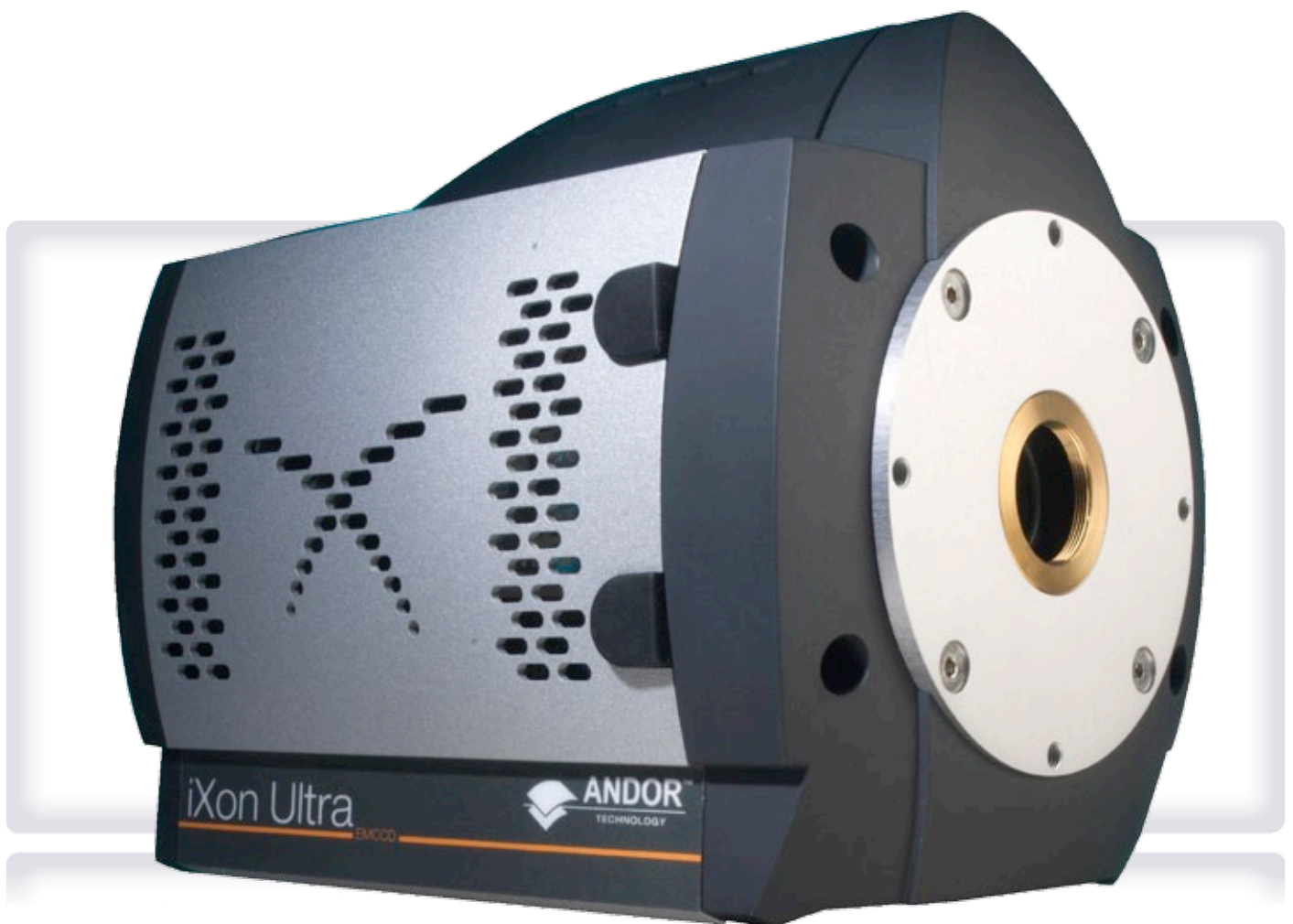

iXon Ultra

TABLE OF CONTENTS	
SAFETY AND WARNINGS INFORMATION	12
SYMBOLS	13
MANUAL HANDLING	13
SHIPPING AND STORAGE PRECAUTIONS	13
SECTION 1: INTRODUCTION TO IXON ULTRA HARDWARE	14
1.1 TECHNICAL SUPPORT	14
Europe	14
USA	14
Asia-Pacific	14
China	14
1.2 DISCLAIMER	15
1.3 TRADEMARKS AND PATENT INFORMATION	15
1.4 COMPONENTS	16
1.4.1 Camera description	17
1.4.2 Camera Power Supply Unit	18
1.4.3 Software	18

1.5	SPECIFICATIONS	19
1.6	ACCESSORIES	19
1.7	SAFETY PRECAUTIONS AND MAINTENANCE	20
1.7.1	Care of the camera	20
1.7.2	Regular checks	21
1.7.3	Annual electrical safety checks	21
1.7.4	Replacement parts	21
1.7.5	Fuse replacement	21
1.7.6	Working with electronics	22
1.7.7	Condensation	22
1.7.8	Dew Point graph	23
1.7.9	EM Gain ageing	24
1.7.10	Minimizing particulate contamination	25

SECTION 2: INSTALLATION	26
2.1 INSTALLING THE HARDWARE	26
2.1.1 PC requirements	26
2.2 INSTALLING ANDOR SOLIS SOFTWARE - WINDOWS O/S (XP/VISTA/SEVEN)	27
2.3 NEW HARDWARE WIZARD	30
2.4 CONNECTORS	32
2.5 WATER PIPE CONNECTORS	33
2.6 MOUNTING POSTS	34
2.7 COOLING	35
2.8 STARTUP DIALOG	36

SECTION 3: FEATURES AND FUNCTIONALITY	37
3.1 EMCCD OPERATION	37
3.1.1 Structure of an EMCCD	37
3.1.2 EM Gain and Read Noise	39
3.1.3 EM Gain ON vs EM Gain OFF	40
3.1.4 Multiplicative Noise Factor and Photon Counting	42
3.1.5 EM Gain dependence and stability	44
3.1.6 RealGain™ : Real and Linear gain	45
3.1.7 EM Gain Ageing: What causes it and how is it countered?	46
3.1.8 Gain and signal restrictions	47
3.1.9 EMCAL™	47
3.2 COOLING	48
3.2.1 Cooling options	48
3.2.2 Fan settings	48
3.3 SENSOR READOUT OPTIMIZATION	49
3.3.1 Sensor pre-amp options	50
3.3.2 Variable Horizontal Readout Rate	51
3.3.3 Variable Vertical Shift Speed	52
3.3.4 Output Amplifier selection	53
3.3.5 Baseline Optimization	54
3.3.5.1 Baseline Clamp	54
3.3.5.2 Baseline Level in Crop Mode	55
3.3.6 Binning and Sub Image options	57

3.4	ACQUISITION OPTIONS	57
3.4.1	Capture Sequence in Frame Transfer (FT) Mode	57
3.4.1.1	Points to consider when using FT Mode	58
3.4.2	Capture Sequence in Non-Frame Transfer Mode (NFT) with an FT CCD	59
3.4.2.1	Points to note about using an FT CCD as a standard CCD	60
3.4.3	Capture Sequence for Fast Kinetics with an FT CCD	61
3.4.3.1	Points to consider when using Fast Kinetics mode	61
3.4.4	Keep Clean Cycles	62
3.5	TRIGGERING OPTIONS	65
3.5.1	Triggering options in FT mode	66
3.5.1.1	Internal Triggering (FT)	66
3.5.1.2	External Triggering (FT)	67
3.5.1.3	External Exposure (FT)	69
3.5.2	Triggering options in NFT mode	70
3.5.2.1	Internal (NFT)	70
3.5.2.2	External and Fast External (NFT)	71
3.5.2.3	External Exposure (NFT)	72
3.5.2.4	Software trigger (NFT)	73
3.5.3	Trigger options in Fast Kinetics (FK) mode	74
3.5.3.1	Internal (FK)	74
3.5.3.2	External (FK)	75
3.5.3.3	External Start (FK)	76

3.6	SHUTTERING	77
3.7	COUNT CONVERT	78
3.8	OPTACQUIRE	79
3.8.1	OptAcquire modes	80
3.9	PUSHING FRAME RATES WITH CROPPED SENSOR MODE	81
3.9.1	Cropped Sensor Mode Frame Rates	82
3.10	ADVANCED PHOTON COUNTING IN EMCCDS	83
3.10.1	Photon Counting by Post-Processing	85
3.11	SPURIOUS NOISE FILTER	86

SECTION 4: HARDWARE	87
4.1 EMCCD TECHNOLOGY	87
4.1.1 What is an Electron Multiplying CCD?	87
4.1.2 Does EMCCD technology eliminate Read Out Noise?	87
4.1.3 How sensitive are EMCCDs?	87
4.1.4 What applications are EMCCDs suitable for?	88
4.1.5 What is Andor Technology's experience with EMCCDs?	88
4.2 EMCCD SENSOR	89
4.3 VACUUM HOUSING	90
4.3.1 Thermoelectric cooler	91
4.4 USB 2.0 INTERFACE	92
4.5 OUTGASSING	93
4.6 EXTERNAL I/O	93
4.7 SIGNAL DIAGRAMS	94

SECTION 5: TROUBLESHOOTING	95
5.1 UNIT DOES NOT SWITCH ON	95
5.2 SUPPORT DEVICE NOT RECOGNISED WHEN PLUGGED INTO PC	95
5.3 TEMPERATURE TRIP ALARM SOUNDS (CONTINUOUS TONE)	95
5.4 CAMERA HIGH FIFO FILL ALARM	96
5.5 USE OF MULTIPLE HIGH SPEED USB 2.0 I/O ON ONE CAMERA	96

APPENDIX	98
A.1 GLOSSARY	98
A.1.1 READOUT SEQUENCE OF AN EMCCD	98
A.1.2 ACCUMULATION	99
A.1.3 ACQUISITION	99
A.1.4 A/D CONVERSION	99
A.1.5 BACKGROUND	99
A.1.6 BINNING	99
A.1.7 COUNTS	99
A.1.8 DARK SIGNAL	99
A.1.9 DETECTION LIMIT	100
A.1.10 EXPOSURE TIME	100
A.1.11 FRAME TRANSFER	100
A.1.12 NOISE	101
A.1.12.1 Pixel Noise	101
A.1.12.1.1 Readout Noise	101
A.1.12.2 Fixed Pattern Noise	102
A.1.13 QUANTUM EFFICIENCY/SPECTRAL RESPONSE	102
A.1.14 READOUT	102
A.1.15 SATURATION	102
A.1.16 SCANS (KEEP CLEAN AND ACQUIRED)	102
A.1.17 SHIFT REGISTER	103
A.1.18 SHOT NOISE	103
A.1.18 SIGNAL TO NOISE RATIO	103

B	MECHANICAL DIMENSIONS	104
C	DECLARATION OF CONFORMITY	105
D	HARDWARE AND SOFTWARE WARRANTY SERVICE	107
D.1	Service Description	107
D.2	Access to Service	107
D.3	Hardware Remediation	108
D.4	Software Remediation	109
E	THE WASTE ELECTRONIC AND ELECTRICAL EQUIPMENT REGULATIONS 2006 (WEEE)	109

SAFETY AND AND WARNINGS INFORMATION

PLEASE READ THIS INFORMATION FIRST



1. To ensure correct and safe operation of this product, please read this guide before use and keep it in a safe place for future reference.
2. If the equipment is used in a manner not specified by Andor, the protection provided by the equipment may be impaired.
3. Before using the system, please follow and adhere to all warnings, safety, manual handling and operating instructions located either on the product or in this User Guide.
4. The Andor iXon Ultra camera is a precision scientific instrument containing fragile components. Always handle with care.
5. Do not expose the product to extreme hot or cold temperatures.
6. Ensure that the ventilation slots in the camera case are free from blockages.
7. Do not expose the product to open flames.
8. Do not allow objects to fall on the product.
9. Do not expose the product to moisture, wet. or spill liquids on the product. Do not store or place liquids on the product. If spillage occurs on the product, switch off power immediately and wipe off with dry, lint-free cloth. If any ingress has occurred or is suspected, unplug mains cable, do not use, and contact Andor service.
10. The product contains components that are extremely sensitive to static electricity and radiated electromagnetic fields, and therefore should not be used, or stored, close to EMI/RFI generators, electrostatic field generators, electromagnetic or radioactive devices, or other similar sources of high energy fields.
11. Operation of the system close to intense pulsed sources (e.g. plasma sources, arc welders, radio frequency generators, X-ray instruments, and pulsed discharge optical sources) may compromise performance if shielding of the Camera is inadequate.
12. Use only the power supply cord provided with the system for this unit. Should this not be correct for your geographical area contact your local Andor representative.
13. Only the correctly specified mains supply must be used.
14. Make sure the electrical cord is located so that it will not be subject to damage.
15. There are no user-serviceable parts in the camera. Only authorised service personnel may service this equipment .
16. Users must be authorised and trained personnel only; otherwise this may result in personal injury, and/or equipment damage and impaired system performance.

About the Andor Ixon Ultra

SAFETY & AND WARNINGS INFORMATION

The following are explanations of the symbols found on this product:

 This product has been tested to the requirements of CAN/CSA-C22.2 No. 61010-1, 2nd edition, including Amendment 1, or a later version of the same standard incorporating the same level of testing requirements

 The iXon Ultra camera head requires a Direct Current (DC) supply.



Caution, refer to manual before use

MANUAL HANDLING

Due to the delicate nature of some of the components within, care must be exercised when handling this product. Proper manual handling techniques are important when unpacking and installing the system to ensure that the integrity of the product is safeguarded and individuals involved are not exposed to unnecessary manual handling risks, such as:

- Lifting a load that is too heavy
- Poor posture or technique during lifting
- Dropping a load
- Lifting objects with sharp edges

SHIPPING AND STORAGE PRECAUTIONS

Unpacking and Inspection:

- Carefully unpack the unit and retain packaging to return equipment for servicing.
- If the equipment appears damaged in any way, return it to sales outlet in its original packaging. No responsibility for damage arising from the use of non-approved packaging will be accepted.
- Ensure all items and accessories specified on the bulleted list in Section 1.5 are present.

If any items are missing, please contact your local sales outlet

SECTION 1 - INTRODUCTION TO IXON ULTRA HARDWARE

Thank you for choosing the **Andor iXon Ultra**. You are now in possession of a revolutionary new **Electron Multiplying Charge Coupled Device (EMCCD)**, designed for the most challenging low-light imaging applications. This manual contains useful information and advice to ensure you get the optimum performance from your new system. If you have any questions regarding your iXon Ultra system, please feel free to contact Andor directly, or via your local representative or supplier. You can find contact details below.

1.1 - TECHNICAL SUPPORT

If you have any questions regarding the use of this equipment, please contact the representative* from whom your system was purchased, or:

Europe

Andor Technology plc
7 Millennium Way
Springvale Business Park
Belfast
BT12 7AL
Northern Ireland
Tel. +44 (0) 28 9023 7126
Fax. +44 (0) 28 9031 0792

www.andor.com/contact_us/support_request

Asia-Pacific

Andor Technology (Japan)
4F NE Sarugakucho Building
2-7-6 Sarugaku-Cho
Chiyoda-Ku
Tokyo 101-0064
Japan
Tel. +81-3-3518 6488
Fax. +81-3-3518 6489

www.andor.com/contact_us/support_request

USA

Andor Technology
425 Sullivan Avenue
Suite # 3
South Windsor
CT 06074
USA
Tel. +1 (860) 290-9211
Fax. +1 (860) 290-9566

www.andor.com/contact_us/support_request

China

Andor Technology
Room 1213, Building B
Luo Ke Time Square
No. 103 Huizhongli
Chaoyang District
Beijing, 100101 P.R.
China
Tel: +86 (0)10 51294977
Fax. +86(0)10-6445-5401

www.andor.com/contact_us/support_request

* The latest contact details for your local representative can be found on our website.

1.2 - DISCLAIMER

The information contained herein is provided "as is" without warranty, condition or representation of any kind, either express, implied, statutory or otherwise, including but not limited to, any warranty of merchantability, non-infringement or fitness for a particular purpose.

In no event shall Andor be liable for any loss or damage, whether direct, indirect, special, incidental, consequential or otherwise howsoever caused whether arising in contract tort or otherwise, arising out of or in connection with the use of the information provided herein.

This equipment has not been designed and manufactured for the medical diagnosis of patients.

COPYRIGHT AND PROTECTIVE NOTICES:

The copyright in this document and the associated drawings are the property of Andor Technology plc and all rights are reserved. This document and the associated drawings are issued on condition that they are not copied, reprinted or reproduced, nor their contents disclosed.

The publication of information in this documentation does not imply freedom from any patent or proprietary right of Andor Technology plc or any third party.

1.3 - TRADEMARKS AND PATENT INFORMATION

Andor, the Andor logo and iXon Ultra are trademarks of Andor Technology plc. All other marks are property of their owners. Changes are periodically made to the product and these will be incorporated into new additions of the manual.

1.4 - COMPONENTS

The Andor iXon Ultra system comprises the following main items:

- Detector head (hereinafter referred to as a Camera - see **Figure 1** on **page 17**)
- PS-90 power supply
- ACZ-03452 timing cable
- AC power cord
- USB Cable 3 metres long
- User manuals on CD
- Software disk (SDK and/or Solis if ordered)
- Andor Programmer guide to Andor Basic (if ordered)
- Software Development Kit manual (if SDK ordered)
- Camera specific performance booklet or sheet
- Correct power cable for the country in which the camera is to be used.
- Mounting Posts (see **page 34**)
- C-mount stopper for EMCal

1.4.1 - Camera description

The iXon Ultra camera is shown below. The camera has evolved from the iXon and iXon3 systems, with the introduction of a USB 2.0 interface instead of the previous proprietary interface and PCI card. The camera re-uses many of the strengths of the iXon3 including the high performance vacuum assembly and much of the camera triggering and control logic.

As well as the convenient USB interface, and faster readout speeds, the iXon Ultra integrates on-head digital processing so that filtered images can be accessed at the full speed of the camera and not limited by the processing power of the associated PC.



Figure 1: iXon Ultra camera

1.4.2 - Camera Power Supply Unit

The iXon Ultra system is designed to be powered from an SW4189 external PSU (Andor P/N PS-90) as shown in **Figure 2**. This requires an AC mains input between 100-240 V, 47-63 Hz and a maximum supply current of 1.6 A.

The output of the SW4189 is 12 V DC at 9 A maximum. However the maximum camera power consumption is 12 V at 6 A = 72 Watts. The SW4189 PSU is fitted with an IEC connector for the electrical supply input. The connection to the iXon Ultra is made via a 3 pin Redel cable plug (Part No. PAH.N0.3GL.LC65GZ).

 The SW4189 is for use with Telecommunications, Computer, Industrial Controller and OA Systems and must only be used indoors.

 The iXon Ultra camera head requires a Direct Current (DC) supply.



Figure 2: PS-90 PSU

NOTE :The electrical mains lead should be certified for use in your country and in applicable countries the plug must be fitted with a 240V 5A fuse. If users use any other power supply, they do so at their own risk

1.4.3 - SOFTWARE

Your iXon Ultra may have been supplied with Andor Solis or Andor iQ software, or with the Andor SDK. However it is also compatible with a range of third party software options offering optimized acquisition control and analysis functionality. For further details of Andor software capabilities and software options, please go to the following page on our website: <http://www.andor.com/products/software/>

1.5 - SPECIFICATIONS

PARAMETER	SPECIFICATION
Power supply ratings	100 - 240 V, 47 - 63 Hz, 1.6 A
Location to be used	Indoor use only
Altitude	Up to 2000 m
Operating temperature range	0°C to 30°C
Storage temperature	-20°C to +55°C
Operating relative humidity	< 70% non-condensing
Overvoltage category	CAT II
Pollution degree	2
Ingress protection rating	IP20
Cooling water flow rate	> 0.75 litre/minute
Control interface	USB 2.0
Electromagnetic compatibility	This is a Class B product.
Cooling vent clearance	100 mm minimum
Dimensions	138 x 188 x 165 mm [5.44 x 7.41 x 6.50 inches]
Weight (camera head only)	3.5 kg [7.8 lb]

Specifications are subject to change without notice

1.6 - ACCESSORIES

The following accessories are available for your iXon Ultra system:

ANDOR PART NUMBER	ITEM DESCRIPTION
OPTOMASK	Optomask microscopy accessory, used to mask unwanted sensor area during cropped Sensor mode acquisition
XW-RECR	Re-circulator for enhanced cooling performance
ACC-XW-CHIL-160	Oasis 160 Ultra compact chiller unit
OA-CNAF	C-mount to Nikon F-mount adapter
OA-COFM	C-mount to Olympus adapter
OA-CTOT	C-mount to T-mount adapter
ACZ-03453	Multi i/o cable with Fire, Shutter, External Trigger, Arm & I2C
ACZ-03454	Multi i/o advanced cable - 16 BNC connections

1.7 - SAFETY PRECAUTIONS AND MAINTENANCE

1.7.1 - Care of the camera

WARNINGS:

1. The camera is a precision scientific instrument containing fragile components. Always handle with the care necessary for such instruments.
2. There are no user serviceable parts inside the camera. If the head is opened the warranty will be void.
3. The camera should be mounted so that the mains supply can be easily disconnected. In case of emergency, the disconnecting device is the mains lead. This will either be the mains lead connected to the product or, in the case of a cabinet-based system, the mains lead to the cabinet.
4. To prevent accidental internal damage to the camera, objects small enough to enter the slots on the sides of the camera should be placed well away from these slots.
5. Ensure that a minimum clearance of approximately 100 mm (4") is maintained in front of all ventilation slots and the fan inlet. Cooling performance cannot be guaranteed unless these criteria are observed.
6. Only use a dry, clean, lint free cloth to clean all painted surfaces. If necessary, use a water diluted detergent to lightly dampen the cloth - do not use Isopropyl alcohol, solvents or aerosols.
7. To clean the window, remove loose particulate matter with an oil-free air blower. If the component is still not clean, it may be drag wiped using folded lint free, clean, lens tissue dampened with pure methanol.
8. If the equipment is used in a manner not stated by Andor, the protection provided by the equipment may be impaired.

1.7.2 - Regular checks

The state of the product should be checked regularly, especially the following:

- The integrity of the enclosure
- Any water hoses used
- The AC/DC External Power Supply
- The mains cable

NOTE: Do not use equipment that is damaged.

1.7.3 - Annual electrical safety checks

It is advisable to check the integrity of the insulation and protective earth of the product on an annual basis, e.g. U.K. PAT testing of the PS-90 Power supply.

NOTE: Do not use equipment that is damaged

1.7.4 - Replacement parts

A PS 90, which is the only external power supply recommended for use with the iXon camera, has been supplied to you. If this unit fails or is damaged, please contact Andor for a replacement. Depending on the Terms and Conditions of your Warranty, you may be charged for this replacement.

1.7.5 - Fuse replacement

The camera itself does not have a fuse. However, if a U.K. (BS 1363) mains lead has been supplied, it contains a fuse, whose characteristics are as follow:

- Rated Current: 5 A
- Rated Voltage: 240 Vac.
- Type: BS 1362
- Size: 6.3 × 25.4 mm (¼ × 1 inches) cartridge

1.7.6 - Working with electronics

The computer equipment that is to be used to operate the iXon Ultra should be fitted with appropriate surge/EMI/RFI protection on all power lines. Dedicated power lines or line isolation may be required for some extremely noisy sites. Appropriate static control procedures should be used during the installation of the system. Attention should be given to grounding. All cables should be fastened securely into place in order to provide a reliable connection and to prevent accidental disconnection.

The circuits used in the camera head are extremely sensitive to static electricity and radiated electromagnetic fields and, therefore, they should not be used (or stored close to) EMI/RFI generators, electrostatic field generators, electromagnetic or radioactive devices, or other similar sources of high energy fields. Types of equipment that can cause problems include Arc welders, Plasma sources, Pulsed-discharge optical sources, Radio frequency generators and X-ray instruments.

1.7.7 - Condensation

You may see condensation on the outside of the camera body if the temperature of the cooling water is too low or if the water flow is too great. The first signs of condensation will usually be visible around the connectors where the water tubes are attached. In such circumstances switch off the system, disconnect the power supply and wipe the camera with a soft, dry cloth. It is likely there will already be condensation on the cooling block and cooling fins inside the camera. Please also carry out the following actions:

- Set the camera aside to dry for several hours before you attempt re-use
- Before re-use blow dry gas through the cooling slits on the side of the camera to remove any residual moisture
- Use warmer water or reduce the flow of water when you start using the device again
- Check Dew Point

1.7.8 - Dew Point graph

The graph in **Figure 3** below plots the relationship between Relative Humidity and Dew Point at varying Ambient Temperature. This can be used to calculate the minimum temperature the cooling water should be set to.

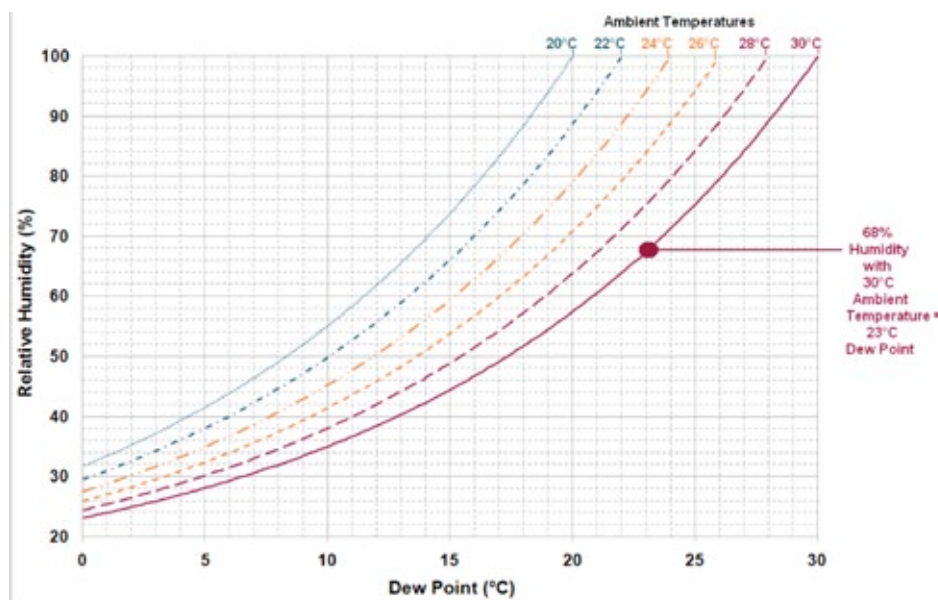

Figure 3: Dew Point Graph

For example, when using an iXon Ultra 897, you will need 10°C cooling water to guarantee performance down to -100°C. In the relatively dry atmosphere of an air-conditioned lab, cooling water at 10°C should not present any problems.

However, in humid conditions (such as exist in some parts of the world) condensation may occur, resulting in damage to the head. In such conditions you will have to use warmer water (20°C or even higher if it is very humid). The minimum CCD temperature would then be limited to a higher value.

1.7.9 - EM Gain ageing

It has been observed that some EMCCD sensors, more notably in cameras that incorporate L3Vision sensors from e2v, are susceptible to EM Gain fall-off over a period of time. It is important to note that this ageing effect applies to any EMCCD camera manufacturer that incorporates L3Vision sensors into their cameras. The Andor iXon Ultra 897 model uses an L3Vision sensor.

A technical note entitled: '**EMCCD - RealGain™ & EMCAL™**', which further explains this phenomenon, can be downloaded from the following website: <http://www.andor.com/library/publications/?app=543>

If left unchecked, this ageing phenomenon has the potential to significantly compromise the long-term quantitative reliability of EMCCD cameras. Andor has recognized this ageing issue and has implemented innovative measures to stabilize the EM Gain on these sensors, ensuring that this ground-breaking ultra-sensitive technology can deliver a prolonged quantitative service to the user and if these highly sensitive sensors are used with due care and attention, ageing can be minimized and should not present any real problem to the user.

More details of this ageing effect and Andor's solutions can be found on **page 46**, but listed below are some guidelines to minimize the EM Gain ageing process:

- Do not use EM Gain values greater than necessary to overcome the read noise. A rule of thumb is that a gain of x4 or x5 the rms read noise (accessible from the spec sheet or performance sheet) is more than sufficient to render this noise source negligible. In practice, this can be achieved with EM Gain of less than x300 at 10 MHz and x450 for 17MHz operation. Pushing gain beyond this value would give little or no extra Signal to Noise benefit and would only reduce dynamic range.
- Only select the extended EM Gain scale of x1000 for single photon counting applications and always ensure that the signal falling onto the sensor is indeed within the regime of low numbers of photons per pixel.
- Turn down the gain when the camera is not acquiring.
- Try not to over-saturate the EMCCD sensor.

1.7.10 - Minimizing particulate contamination

It is important that particulate contamination of the exterior of the camera window is kept to a minimum, such that images are kept free of 'shadowing' particles directly in the optical path. The iXon Ultra range comes equipped with an internal C-mount shutter. Whilst not being required for frame transfer operation (which is a shutter-free readout mode) it is good practice to close the shutter when the camera is not in acquisition use for a reasonable period. It is also advisable to use the software to close the shutter when exposing the camera to the 'open environment' (i.e. removed from a microscope C-mount or focusing lens) whilst power is still flowing to the camera.

When SOLIS is exited the shutter (if fitted) will close automatically. We recommend that the C-mount opening is covered when the camera is not in use.

If there is evidence of particulate contamination on the front window it is possible to clean the window by blowing oil free dry air gently over the window surface. However, the shutter has to be kept open for this procedure, which means that the camera has to be powered up. Therefore, since light can access the EMCCD sensor during this time, we recommend that EM Gain is turned off (readily selectable through the software).

SECTION 2: INSTALLATION

2.1 - INSTALLING THE HARDWARE

2.1.1- PC requirements

It is convenient to install the Software before first connecting the camera – this will ensure that USB drivers are available when required.

There are no restrictions on the order in which components are connected. It is best to allow a few seconds from camera power on (using the button or a mains switch) to starting Solis in order for the camera to be recognised by the PC.

- 3 GHz Quad Core or 2.4 GHz multi core processor
- 2 GB RAM
- 100 MB free hard disc to install software (at least 1 GB recommended for data spooling)
- USB 2.0 High Speed Host Controller capable of sustained rate of 40MB/s
- Windows (XP, Vista or 7) or Linux

To connect the camera use the supplied power block to power the camera. A faint beep may be heard when the camera is turned on. Note: The iXon Ultra has a power switch on the camera head for convenience.

Connect the supplied USB lead to the PC. (A USB socket on the rear of a desktop machine is preferred.)

The supplied Multi i/o cable may be required depending on the measurement being carried out. Consult **page 19** for details.

The camera can achieve stated performance with air cooling using the internal fan – Water cooling is also available see **page 48** for details.

2.2 - INSTALLING ANDOR SOLIS SOFTWARE - WINDOWS O/S(XP/VISTA/SEVEN)

1. Terminate and exit any programmes that are running on the PC.
2. Insert the Andor CD. The **InstallShield Wizard** now starts. If it does not start automatically, run the file **setup.exe** directly from the CD then follow the on-screen prompts that then appear, e.g.:

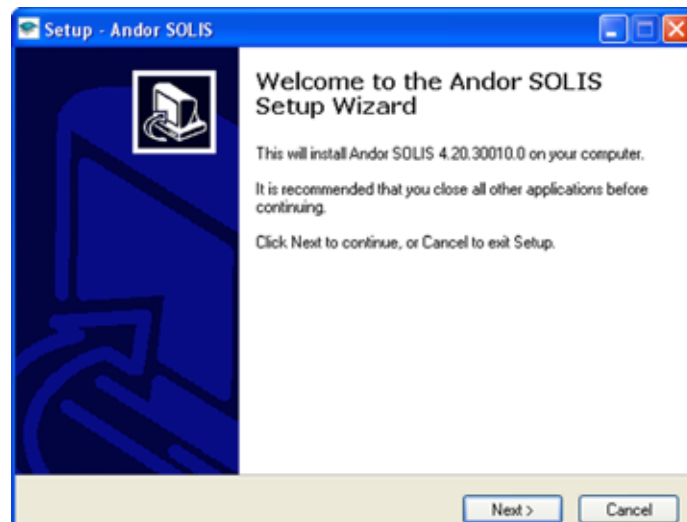

3. Click **Next >** and the following dialog box appears:

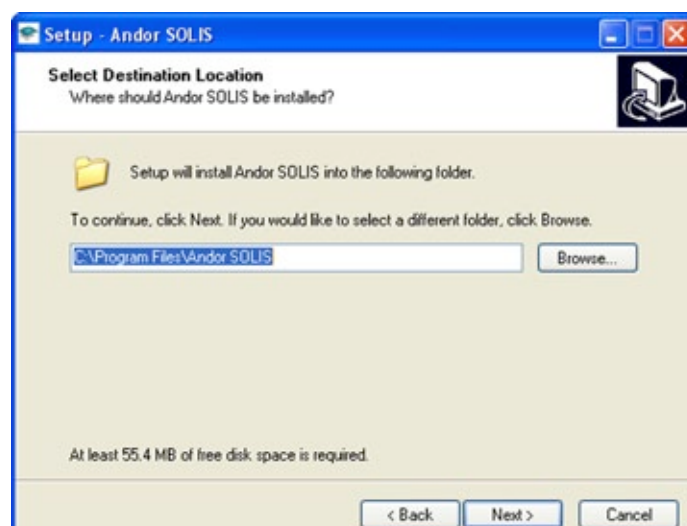

4. Click **Next >** (alternatively, click on Browse..., choose your own file destination then click **Next >**).

5. Select **iXon Ultra** as shown above then click **Next>** and the following dialog box appears:

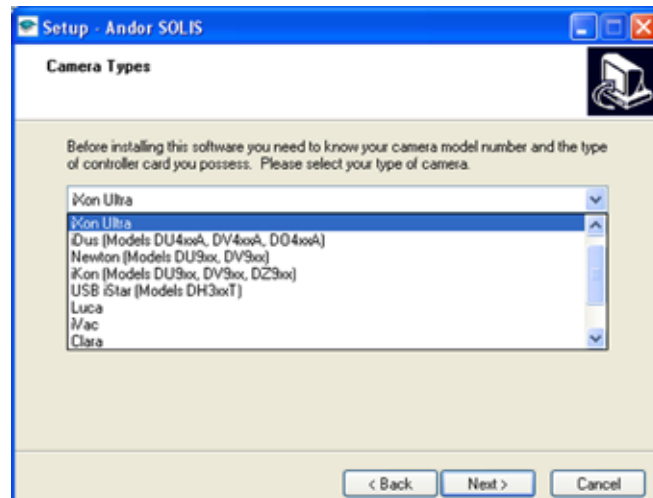

6. Click **Next >** (alternatively, click on **Browse...**, choose your own shortcut destination then click **Next >**).

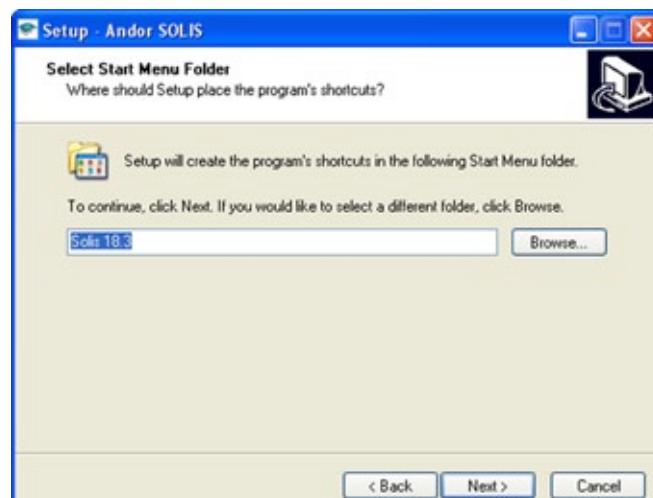

7. Select (or de-select) the additional tasks to be performed during the set-up, then click **Next>**:

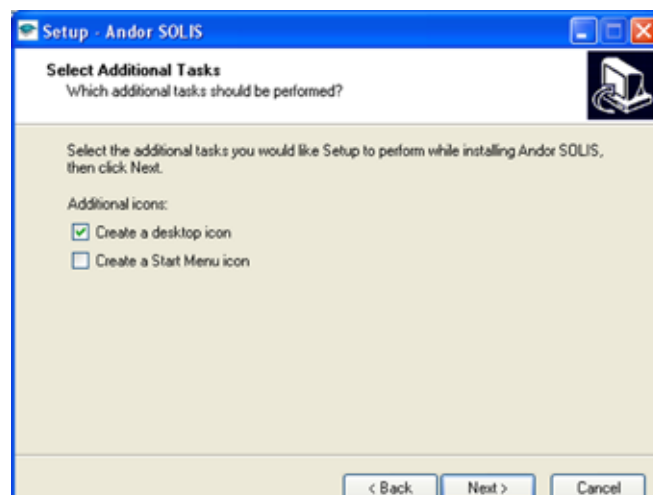

8. Click **Install** to continue with the installation (or click **<Back**, if you want to review / change any settings. When **Install** is pressed an update progress bar will appear while the installation is performed, e.g. :

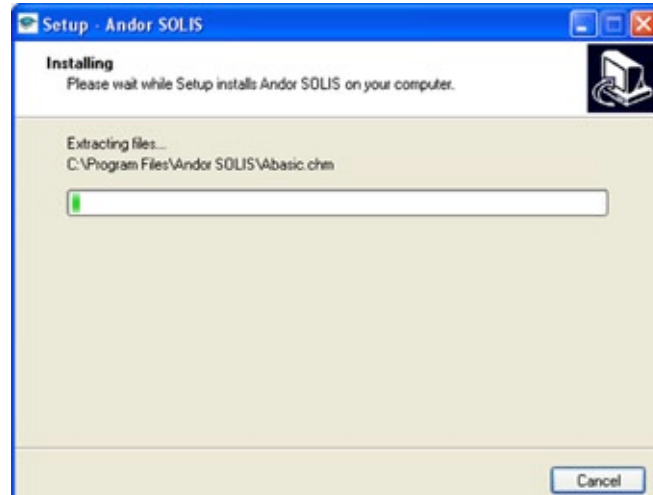

9. When the hardware installation has been completed, the following screen will appear:

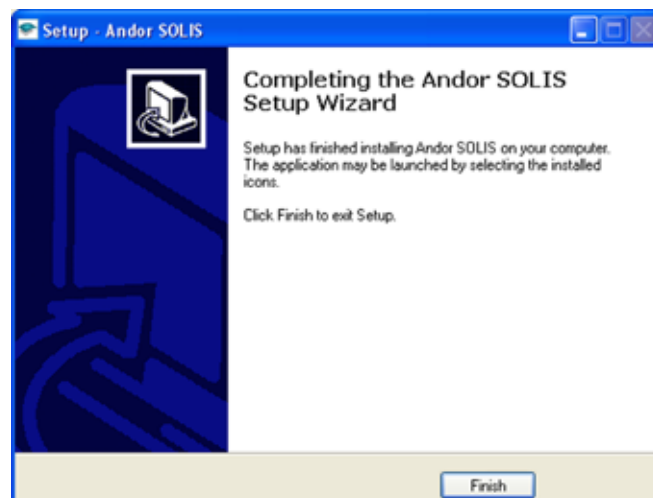

2.3 - NEW HARDWARE WIZARD

When the first iXon Ultra camera is connected to a PC for the first time, the **Found New Hardware Wizard** screen will appear, e.g.:



1. Select the **'No, not this time only'** option then click **Next>** and the following screen appears:

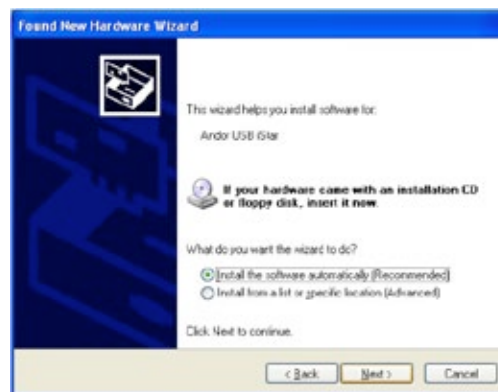

2. Select the **'Install from a list or specified location (Advanced)'** option then click **Next>**. The following screen appears:

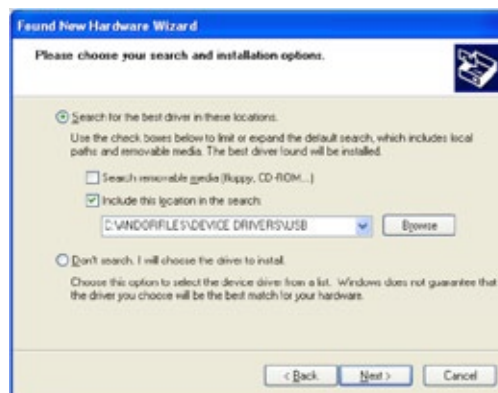

3. Navigate to the directory where the Andor Solis software was installed to on the PC, then click **Next>**

4. The installation wizard will run, e.g.:

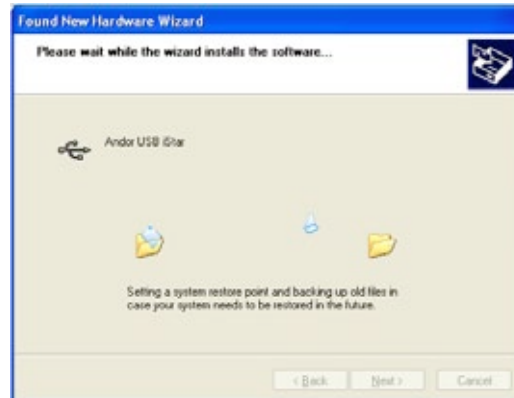

5. When the hardware installation has been completed, the following screen will appear:

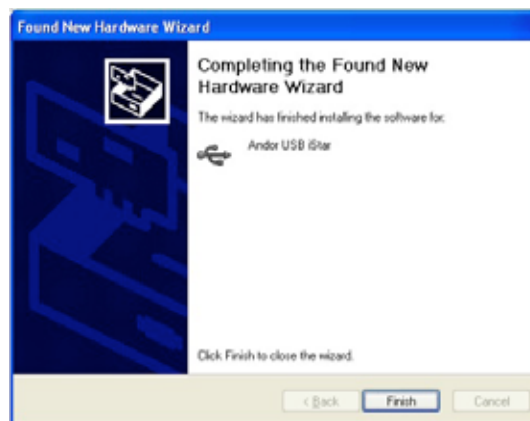

6. Click the **Finish** button to complete the installation.

NOTE: If the camera is connected to a different USB port, steps 1 – 6 will have to be repeated on the first connection only. This is a feature of how Windows deals with the USB interface.

On the first startup of Solis, you may be required to direct the software to the iXon Ultra drivers. If so, select the directory that Andor Solis was installed to.

2.4 - CONNECTORS

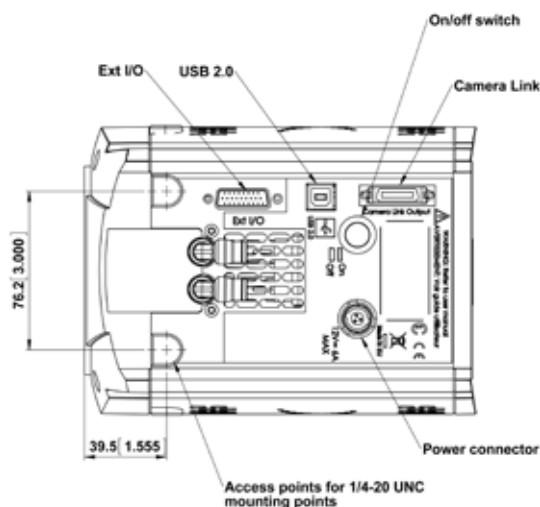

Figure 4: iXon Ultra connectors

The Power connection is for the **Power Supply Unit (PSU)** described on **page 18**. Note the connector has a locking action. The USB should be connected to the PC with the supplied USB 2.0 cable – this type (with cable ferrite) was used during EMC testing. An alternative cable with locking adaptor is available.

The iXon Ultra is supplied with an ACZ-03452 cable for the external I/O connector. This provides industry-standard **BNC** connectors, details as shown hereunder:

- **Fire** (please refer to **pages 65-76**)
- **Shutter** (see **page 77**)
- **Arm** (please refer to **pages 65-76**)
- **Ext. Trig (External Trigger Input)** (please refer to **pages 65-76**)

These are used to send/receive Trigger and Fire signals. The outputs (Fire & Shutter) are CMOS compatible & series terminated at source (i.e. in the camera head) for a 50Ω cable.

NOTES:

1. The termination at the customer end should be high impedance (>1KΩ) as an incorrect impedance match could cause errors with timing and triggering.
2. The External Trigger Input is TTL level and CMOS compatible and has 470Ω impedance.
3. Signal diagrams of these connections can be found on pages 93 & 94. The interfaces and internal circuits of the iXon Ultra are rated as SELV (Safety Extra Low Voltage), all interfacing equipment should use SELV voltage and current levels.
5. OutputDAC1 and OutputDAC2 are 16 bit DAC outputs that can be configured by the user to be up to approximately 10.1 Volts. Maximum output current that can be drawn is 10mA
6. +5V Output is a 5V supply to signal to the user that the camera is powered up. Maximum current that can be drawn from this is 500mA
7. I/O bits (8 off) are user programmable and can either be inputs or outputs. When being used as inputs these default to being weakly pulled high. The maximum low level input voltage is 1.5V and the minimum high level input voltage is 3.5V. As outputs the maximum “high” level output current that can be drawn is 0.03mA and the maximum “low” level current that each output can sink is 10mA.

There are an I2C connection point, 2 x16 bit DACs, and 8 digital i/os available on the External I/O. To access these connections requires an advanced cable (ACZ-03453 or ACZ-03454) to connect to the 26 way High density D connector.

The Cameralink connection is for use with a Cameralink frame grabber or custom hardware implementations.

2.5 - WATER PIPE CONNECTORS

Two barbed coolant hose inserts are supplied as standard with the iXon Ultra camera, suitable for connection to 6 mm (0.25”) internal diameter soft PVC tubing / hose. The recommended tubing should have 10 mm (0.4”) outside diameter, i.e. a wall thickness of 2 mm (0.08”). Alternative hose dimensions and materials should be thoroughly tested to ensure a leak tight seal is achieved with the barbed inserts. Once the hose has been secured to the barbs, connection to the camera is achieved by clicking both hose inserts into the quick-release couplings on the side of the camera head.

Before attempting to remove the hose connections, the user should ensure that all water has been drained from the hoses and integral coolant channel within the camera head. Care must be taken to avoid permanent damage to the camera system resulting from either leakage of coolant during connection / removal of hoses or spillage of any residual coolant contained within the camera head once the hoses have been removed.

Removal of the coolant hoses is achieved by depressing the collar on the quick-release couplings that releases the hose insert connections, as shown below in **Figure 5**.



Figure 5: Removal of coolant hose inserts from quick release couplings on camera head

Some mains supply water is heavily mineralized (i.e. “Hard”) .which could cause deposits in the water circuit inside the camera. This can reduce the flow-rate and effect the cooling achieved, therefore to prevent deposits forming it is recommended that de-ionized water (without additives) is used as the coolant.

The specified cooling performance of the camera can be achieved with coolant flow rates of 2 litres per minute, the maximum recommended pressure of coolant circulating through the camera head is 2 bar (30 PSI).

In the event that replacement hose inserts / barbs are required, please contact your local Andor representative.

NOTE: Always ensure that the temperature of the liquid coolant circulated through the camera head is above the dew point of the camera ambient. Use of coolant at or below the dew point will result in permanent damage to the camera head, due to formation of condensation on internal components.

2.6 - MOUNTING POSTS

- Mounting posts can be fitted on all four sides of the camera. These can be used to mount the camera if the C-Mount is not used, or to mount accessories.

Note: A bag containing two Ø1/2" x 80 mm long x 1/4-20 UNC posts is included with all kits.

- There are 4 pairs of holes for the mounting posts, each with 2.0" spacing.

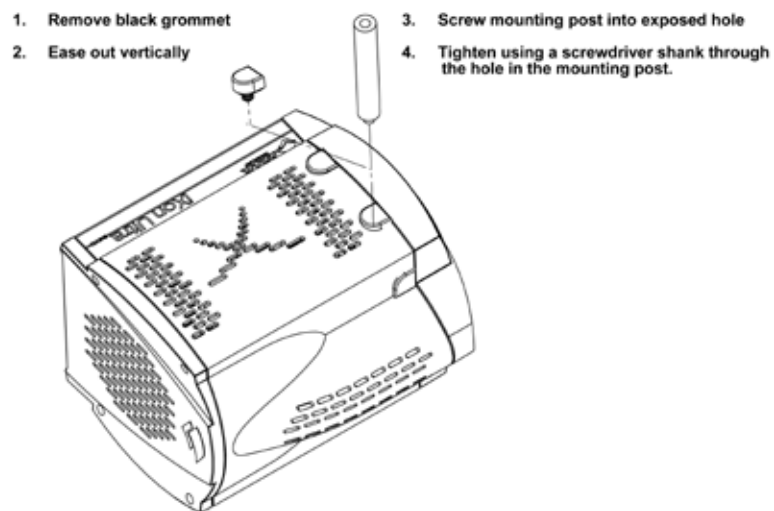
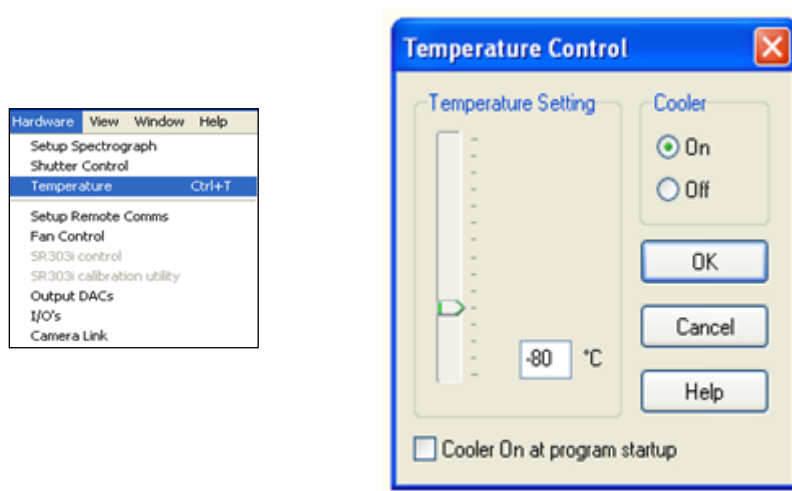

Figure 6: Mounting post installation

2.7 - COOLING

For accurate readings, the EMCCD Sensor should first be cooled to a stable temperature. This will help reduce dark signal and associated shot noise.

The Temperature Control Dialog is accessed via the **Hardware...Temperature** menu item or by double clicking on the temperature display **OFF** at the bottom left corner of the main SOLIS application window:



Once the cooler is switched ON the current temperature is displayed in the bottom left of the main application window and the background of the icon will turn red. **25°C**

As the system cools, the temperature displayed will decrease in 1°C increments. When the required temperature has been reached (this may take some minutes), the background of the icon will change color to blue. **-80°C**

NOTE: Please refer to COOLING in section 1 for details of minimum achievable temperatures, and important advice on avoiding overheating.

2.8 - START-UP DIALOG

On start-up of the Solis software a dialog will appear, offering a selection of cameras currently connected to your PC, e.g.:

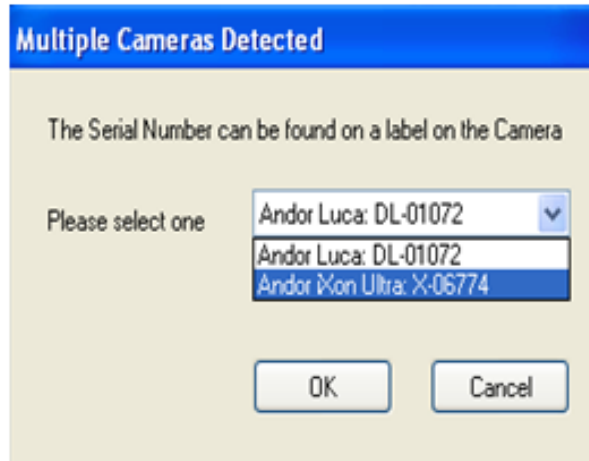

Highlight the **Andor iXon Ultra** camera and click **OK** to continue with the selected camera.

SECTION 3 - FEATURES AND FUNCTIONALITY

3.1 - EMCCD OPERATION

3.1.1 - Structure of an EMCCD

Advances in sensor technology have led to the development of a new generation of ultra-sensitive, low-light **E**lectron **M**ultiplying **C**harged **C**oupled **D**evelopments (**EMCCDs**). At the heart of your iXon Ultra camera is the latest **EMCCD**, a revolutionary technology, capable of single photon detection. An **EMCCD** is a silicon-based semiconductor chip bearing a two-dimensional matrix of photo-sensors or **pixels**. This matrix is usually referred to as the image area. The pixels are often described as being arranged in rows and columns, the rows running horizontally and the columns vertically. The **EMCCD** in the camera is identical in structure to a conventional **C**harged **C**oupled **D**evice (**CCD**) but with the **shift register** extended to include an additional section, the **Multiplication** or **Gain Register** as shown in **Figure 7** below:

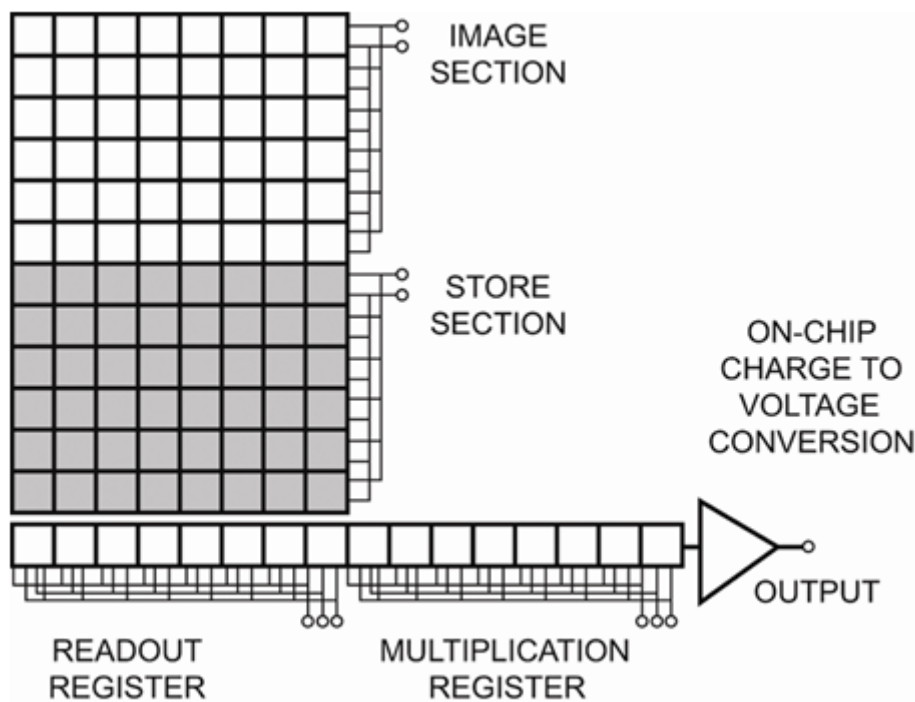

Figure 7: EMCCD structure

During an acquisition using a conventional **Frame Transfer CCD (FT CCD)**, the image area is exposed to light and an image is captured. This image, in the form of an electronic charge, is then automatically shifted downwards behind the masked region of the chip before being read out. To read out the sensor, charge is moved vertically into the readout register, and then horizontally from the readout register into the output node of the amplifier. As stated previously, the readout register is extended to include the **multiplication (gain) register**. The amplification occurs in this register through the scheme highlighted in **Figure 8** below. When moving charge through a register, there is a very tiny, but finite probability that the charges being transferred can create additional charge by a process known as “impact ionization”. Impact ionization occurs when a charge is clocked and has sufficient energy to create another electron-hole pair in the conduction band and by this process amplification occurs. To make this process viable, EMCCD's tailor the process in two ways:

1. Firstly, the probability of any one charge creating a secondary electron is increased by giving the initial electron charge more energy. This is typically done by replacing one of the electrodes (phases) of this readout section with two electrodes. The first is held at a fixed potential and the second is operated as normal, except that much higher voltages are employed than are necessary for charge transfer alone. The large electric field generated between the fixed voltage electrode and the clocked electrode is sufficiently high for the electrons to cause “impact ionization” as they transfer. The impact ionization causes the generation of new electrons, i.e. multiplication or gain.
2. Secondly, the EMCCD is designed with hundreds of cells or pixels in which impact ionization can occur and although the probability of amplification or multiplication in any one pixel is small (only around x1.01 to x1.015 times) over the entire length of the EM register, the probability is very high and substantial gains of up to thousands can be achieved.

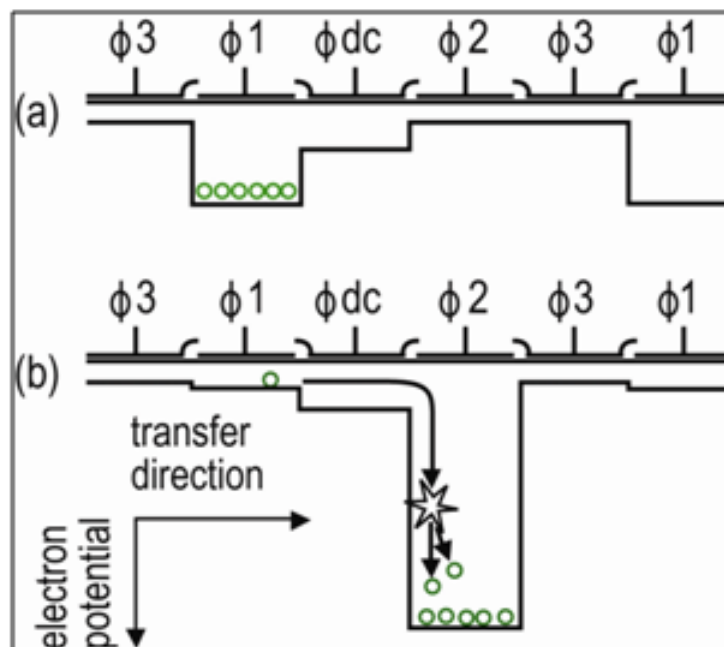

Figure 8: Gain register operation

3.1.2 - EM Gain & Read Noise

As explained previously, EMCCD sensors allow the detected signal to be amplified on the actual sensor itself before being readout through the output amplifier and digitized by the **Analog to Digital (A/D)** converter. The reason that this on-chip-multiplication process gives such a spectacular improvement in low-light detection is that it negates the effect of any electronic noise that may be generated by the read out electronics.

All CCD cameras have an associated minimum electronic noise floor, which is often termed the **Read Noise** of the system. Read noise is produced during the readout process mostly by the output amplifier, but also has contributions from the digitization electronics. This sets the minimum signal level that can be detected by the camera, as any signal level below the read noise level will be indistinguishable from the read noise itself.

Read noise has therefore been the major limiting factor for low-light level detection in CCDs for many years until the introduction of EMCCD cameras by Andor Technology in 2000. By applying EM Gain, a weak signal that would otherwise be indistinguishable from the read noise can be amplified above the read noise level and thus be read out as a useful signal. This amplification of the signal before being read out effectively reduces the read noise level of the camera, and even at relatively modest EM Gain settings the effective read noise can be reduced to less than 1 electron r.m.s.

One other point to note is that, since read noise increases with increased readout rate, the application of EM Gain really comes into its own at higher readout rates, as any increase in the read noise can be overcome simply by increasing the EM Gain. For example, an iXon Ultra 897 typically has a read noise of 50 electrons rms when reading out at 10MHz. This can easily be reduced to < 1 electron by applying > x50 EM Gain.

3.1.3 - EM Gain ON vs EM Gain OFF

Figure 9 below shows **Signal to Noise (S/N)** plots derived from the specifications of the back-illuminated iXon Ultra EMCCDs, read out at 10MHz for a photon wavelength at which the **Quantum Efficiency (QE)** of the sensor is assumed to be 90%. Such plots are very useful to gauge at what signal intensity it becomes appropriate to use EM Gain to increase S/N.

It is clear that at 10MHz readout, one needs to encounter relatively intense signals of > 2900 photons / pixel before it becomes advantageous to operate with EM Gain off. Note that the “ideal” curve represents a pure Signal to Shot Noise ratio and is shown for reference – if the camera had no sources of noise, this is what the curve would appear like. Even with EM Gain turned on, we encounter uniformly lower signal to noise than the ideal curve. This is due to the influence of Multiplicative Noise, which has the effect of increasing the shot noise by a factor of $\sqrt{2}$ or ~ 1.41 .

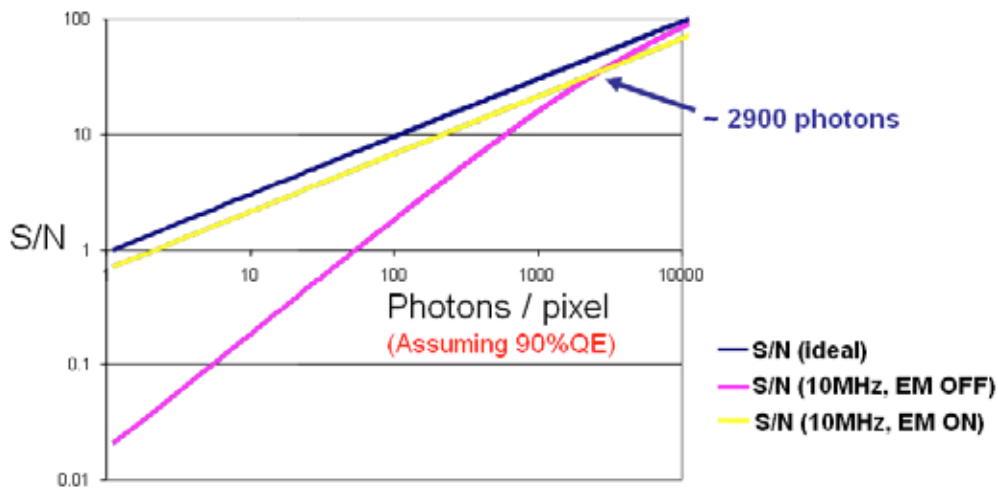

Figure 9: Signal to noise plots EM Gain ON vs. EM Gain OFF for back-illuminated iXon Ultra EMCCDs at 10MHz readout speed

Figure 10 below, shows S/N plots derived from the specifications of the back-illuminated iXon Ultra EMCCDs at 1MHz (slower frame rate operation) read out either with EM Gain ON or, alternatively, through the conventional amplifier (i.e. standard CCD operation). Again, this plot assumes a photon wavelength at which the QE of the sensor is 90%. Specifically this figure applies to models where the user has the choice of either EMCCD or conventional amplifiers.

At these **slower speed operations**, when one has the choice to read out as a “conventional” CCD, it can often be advantageous to do so in order to achieve better signal to noise. Indeed, the plots below show that the cross-over point is at ~42 photons/pixel, at which it is still advisable to read out through the EM amplifier with Gain applied.

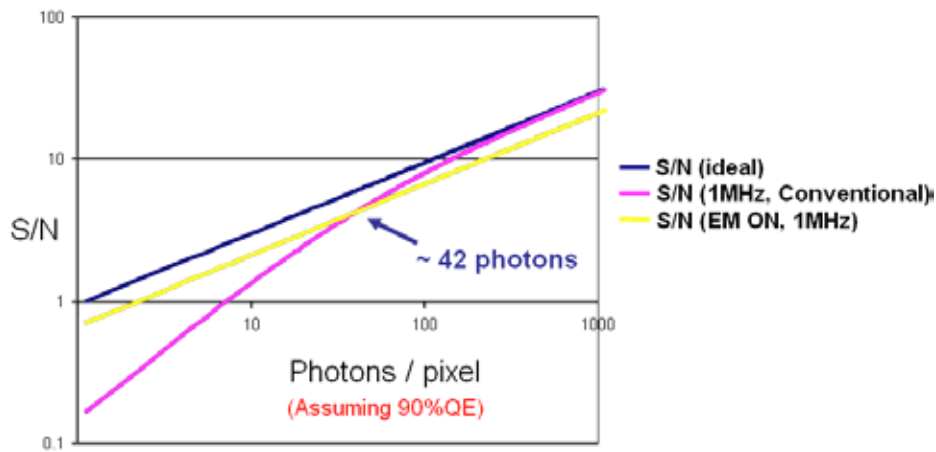

Figure 10: EM Gain ON vs. Conventional Amplifier signal to noise plots for back-illuminated iXon Ultra EMCCDs at 1MHz readout speed

3.1.4 - Multiplicative Noise Factor and Photon Counting

It is impossible to know the exact gain a detected signal charge traversing the EM Gain register will acquire, due to the stochastic nature of the processes which produce EM Gain. However, it is possible to calculate the probability distribution function of output charge for a given input charge.

At reasonably high gain levels (> x30) this uncertainty introduces an additional noise component called **Multiplicative Noise**. This noise source is only present in signal amplifying technologies and is a measure of the uncertainty inherent in the signal multiplying process. For example, during each transfer of electrons from element to element along the gain register of the EMCCD, only a small probability exists that the process of impact ionization will produce an extra electron during that step. This happens to be a small probability but when executed over > 590 steps, a very large overall EM Gain results. However, the downside to this process results from the probabilities! Due to this, there is a statistical variation in the overall number of electrons generated by the gain register from an initial charge packet. This uncertainty is quantified by a parameter called “**Noise Factor**” and detailed theoretical and measured analysis has placed this Noise Factor at a value of $\sqrt{2}$ (or 1.41:1) for EMCCD technology. **Note: This noise source is significantly greater for the Multi Channel Plate (MCP) of ICCDs than for the gain register of the EMCCD. ICCDs have noise factors typically ranging from 1.5 to >2.**

So, this is an additional form of noise that must be taken into account when calculating Signal/Noise for these detectors. However, one way to better understand the effects of this noise source is in terms of an addition to the shot noise of the system. Extra multiplicative noise has the same form as shot noise in that each noise type results in an increase in the variation of number of electrons that are read out of the sensor (under constant uniform illumination).

Indeed, multiplicative noise can be thought to contribute directly to the overall shot noise, in that one should multiply the **Shot Noise** by the **Noise Factor** when calculating overall noise. Simply put, multiplicative noise does not in any way reduce the average signal intensity, or reduce the number of photons that are detected. It simply increases the degree of variation of the signal around the mean value, in addition to the variation that already exists from the shot noise (variation from pixel to pixel or from frame to frame). This additional variation to the signal intensity is represented pictorially overleaf in **Figure 11** as a signal intensity profile.

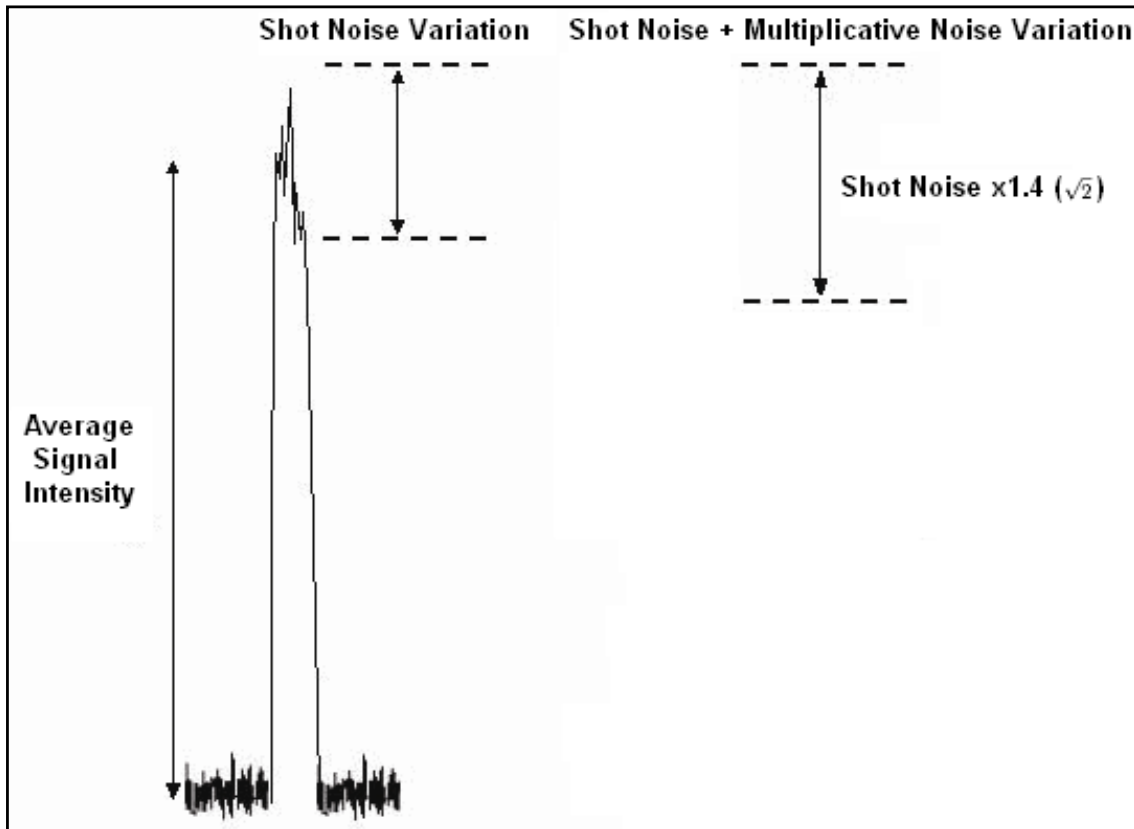

Figure 11: Signal intensity profile

Within the framework of less than 1 electron falling on a pixel in a single exposure, the EMCCD can be used in **Photon Counting Mode**. In this mode, a threshold is set above the ordinary amplifier readout and all events are counted as single photons. In this mode, with a suitably high gain, a high fraction of the incident photons (>90%) can be counted without being affected by the Noise Factor effect.

3.1.5 - EM Gain dependence and stability

EM Gain is a function of the EM voltage and of the sensor operating temperature. When the user applies gain through the software, it is the EM voltage in the gain register that is varied. As can be seen from **Figure 12** below, the dependence of EM Gain on EM voltage is sharp (note the logarithmic scaling). This arises because the signal electrons acquire energy as they are accelerated through the EM electric field, and once this field strength reaches the threshold needed to overcome the bandgap energy, the impact ionization rate rises rapidly. Historically, this sharp dependence has meant that the software control of EM Gain in all EMCCD cameras has been via a non-linear scale with most of the amplification occurring within a relatively small portion at the top of the overall scale. Thus considerable fine tuning by the user to determine an optimal gain setting has been required, and even then the actual gain is determined only through measurement of a stable light source, with and without gain applied.

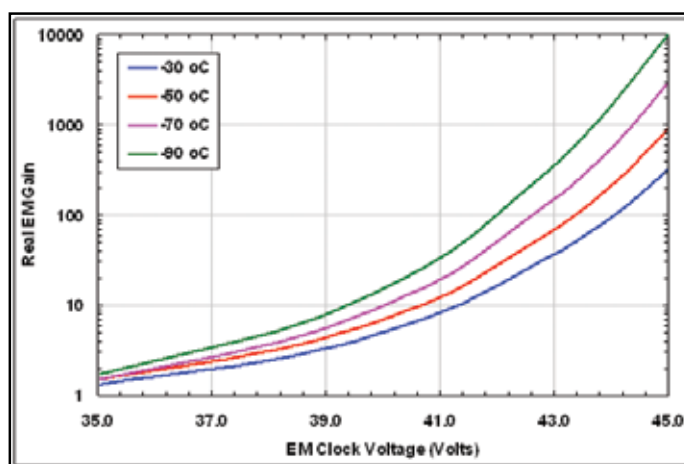

Figure 12: EM Gain vs EM clock voltage

Figure 12 shows how the EM Gain varies with temperature, this dependence arising primarily from photon scattering of electrons when they are accelerating in the EM electric field. The scattering causes a loss of energy, which increases with temperature. To make up this loss and maintain EM Gain, a larger EM electric field must be used at higher temperatures. As can be seen from **Figure 13**, EM Gains well in excess of x1000 can be achieved at low temperatures. However, it is not recommended that gains above x1000 be used because such high gains can cause significant ageing of the gain register (see **EM Gain Ageing** on page 46).

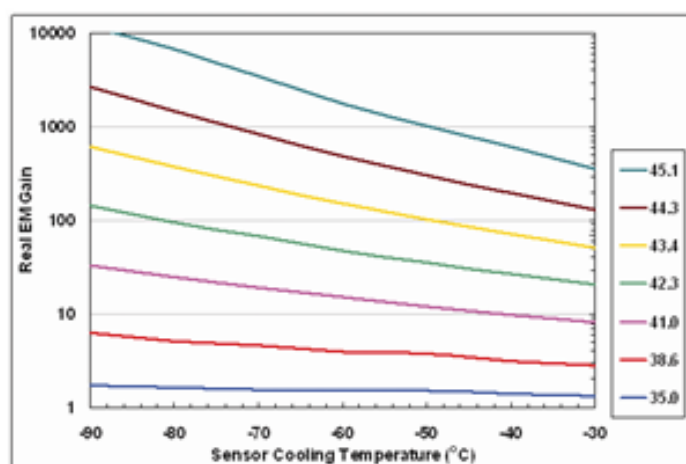

Figure 13: EM Gain vs sensor cooling temperature

3.1.6 - RealGain™: Real and Linear gain

Through a detailed analysis of the complex EM voltage dependence, Andor has successfully converted the relationship between EM Gain and the EM clock voltage setting into a linear one. A salient feature is that the actual EM Gain can be selected directly from a linear scale displayed in software. No more guesswork with arbitrary gain units on a non-linear scale - the gain one chooses is the gain one obtains.

In effect one can select the best gain to overcome noise and maximize dynamic range. Also, although EM Gain is temperature dependent, Andor's linear and real gain calibration extends to any EMCCD cooling temperature. Selecting x300 EM Gain @ -50°C, or at -100°C gives the same x300 actual gain. This delivers a new benchmark of simplicity and ease of operation to the user, and sets a new precedent in what should be expected from EMCCD technology.

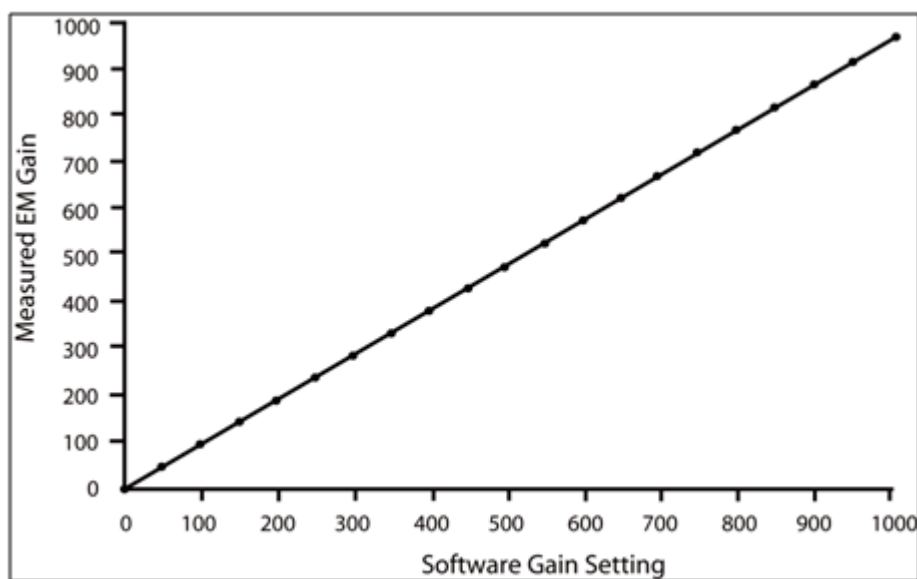

Figure 14: RealGain™ calibration in the iXon Ultra – the same linear relationship holds across all cooling temperatures

3.1.7 - EM Gain Ageing: What causes it and how is it countered?

As already noted in the discussion on safe camera operation in Section 2, EMCCD sensors can suffer from EM Gain ageing. This is the phenomenon whereby the EM Gain falls off over a period of time, when operating at the same clock voltage and cooling temperature. This ageing effect appears to be dependent on the amount of charge that is passed through the gain register, combined with the actual EM electric field strength that it is transferred through. It seems to be very strongly dependent on the EM electric field strength. Therefore when operating at high EM Gains the ageing rate can be disproportionately greater. Fortunately, it has been observed that this ageing effect itself decreases with time, meaning that, with proper use, the device should remain useful for many years. As part of Andor's EMCCD production process, all sensors are exposed to conditions that result in much of the "shorter-term ageing" having already occurred prior to calibration and setting of the EM Gain.

The rationale for this ageing effect is not fully understood, but it is assumed that accelerating charge through the high electric fields is causing a tiny fraction of that charge to become permanently embedded in the insulator (typically silicon dioxide) between the EM electrode and the active silicon. This slow build-up of charge effectively reduces the field strength produced by the electrode. The signal electrons, therefore, experience a lower accelerating potential, which subsequently produces fewer secondary electrons from the impact ionisation process resulting in less electron multiplication and, in effect, a lower EM Gain.

In order to minimise the effect of EM Gain ageing it is recommended that the following guidelines are always adhered to:

- Do not use EM Gains greater than necessary to overcome the read noise (please refer to **Figure 13** on **page 44** and **Figure 14** on **page 45**). A rule of thumb is that a gain of x4 or x5 of the root-mean-square read noise (accessible from the performance sheet) is more than sufficient to render this noise source negligible. In practice, this can always be achieved with EM Gain of less than x500 (much less for the slower readout speeds). Pushing gain beyond this value would give little or no extra S/N benefit and would only reduce dynamic range.
- Only select the extended EM Gain scale of x1000 when **single photon counting** and always ensure that the signal falling onto the sensor is indeed within the regime of low numbers of photons per pixel.
- Turn the EM Gain OFF when not in use.
- Try not to over-saturate the EMCCD detector.

For simplicity and ease of use many of these guidelines have been uniquely woven into the iXon Ultra systems, to make it difficult for the user to step outside of them and unwarily cause accelerated sensor ageing. This defence is two pronged, and makes heavy use of Andor's linear and quantitative gain calibration scale (**RealGain™**) described above.

3.1.8 - Gain and signal restrictions

Part of the measures taken to prevent premature ageing of the sensor has been to invoke temperature compensated real gain limits, coupled with signal intensity feedback (after EM amplification). This ensures that the user is unable to apply excessive gain and/or signal, any more than is necessary to render the read noise floor negligible for a given signal intensity and readout speed. Secondly, when not actually acquiring data, as for for example during “keep clean” cycles or when outside a selected sub-image area, Andor EMCCDs have been internally configured to prevent any unwanted signal entering the EM Gain register. Together, these measures ensure that the rate of EM Gain ageing is significantly reduced.

3.1.9 - EMCAL™

Andor has developed, in the iXon Ultra, a unique and patented method of user-initiated **EM Gain self-recalibration - EMCAL™**.

Thus, even after exercising due care during usage, and the operator availing himself of the above internal restrictions, the EM Gain will gradually decrease over an extended period of time (see **figure 15** below). This reduction in EM Gain can be rectified by using the EMCAL™ self-recalibration process, which is very easily initiated by the user. Check the Andor website for the latest EMCAL™ routine.

This process uses the iXon Ultra in-built temperature compensated linear gain scales to reset the EM Gain calibration to reflect the true values requested on the software scale, in reality giving **RealGain™** values and thus markedly prolonging the operational lifetime and quantitative reliability of the technology, and circumventing the need to return to the factory for recalibration. To the user, this means optimal signal to noise ratio, maximum dynamic range and prolonged system longevity.

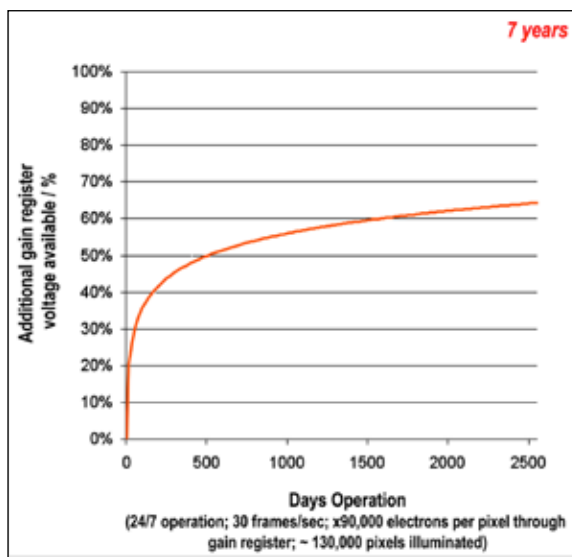

Figure 15: Ageing profile of an Andor backlit EMCCD. Test conditions: 24/7 operation; 30 frames/sec; x90,000 electrons per pixel through gain register; ~ 200,000 pixels illuminated

3.2 - COOLING

The EMCCD sensor is cooled using a Thermoelectric (TE) cooler. TE coolers are small, electrically powered devices with no moving parts, making them reliable and convenient. A TE cooler is actually a heat pump, i.e. it achieves a temperature difference by transferring heat from its “cold side” (the EMCCD sensor) to its “hot side” (the built-in heat sink). Therefore, the minimum absolute operating temperature of the EMCCD depends on the temperature of the heat sink. Andor’s vacuum design means that we can achieve minimum cooling temperatures unrivalled by other manufacturers. The maximum temperature difference that a TE device can attain is dependent on the following factors:

- Heat load created by the CCD (running the camera at the fastest readout rate generates most heat i.e. 17 MHz Full vertical binning)
- Number of cooling stages of the TE cooler
- Operating current

3.2.1 - Cooling options

The heat that builds up on the heat sink must be removed and this can be achieved in one of the two following ways:

1. Air cooling: a small built-in fan forces air over the heat sink
2. Water cooling: external water is circulated through the heat sink using the water connectors on the head and this can take one of the following forms:
 - Recirculation
 - Chilling

All Andor iXon Ultra systems support both cooling options. Irrespective of which method is being employed, it is not desirable for the operating temperature of the CCD simply to be dependent on, or vary with, the heat sink temperature. Therefore, a temperature sensor on the CCD (combined with a feedback circuit that controls the operating current of the cooler) allows stabilization of the CCD to any desired temperature within the cooler operating range.

3.2.2 - Fan settings

The speed of the cooling fan can also be controlled, which is useful if working in experimental configurations that are extremely sensitive to vibration. The vast majority of applications, including optical microscopy, can be used with the default highest fan speed, since the vibrations from the fan are minimal. However, some applications can be extremely sensitive to even the smallest of vibrations (such as when combining an optical set-up with patch clamp electrophysiology or atomic force microscopy) and it can be useful to either select a slower fan speed, or to temporarily turn off the fan altogether, for the duration of the acquisition.

If the fan is being turned off altogether, depending on the cooling temperature selected and on the ambient temperature, the acquisition duration can be as long as 15 - 20 minutes before temperature begins to rise. The fan must then be turned on again to give the head time to re-stabilize (dissipate built-up excess heat from the peltier TE cooler) before the next acquisition is begun.

3.3 - SENSOR READOUT OPTIMIZATION

To allow the camera to be optimized for the widest range of applications, it is important to have flexibility in the readout options available. Some of these include:

- Cooling (please see **page 48**)
- Sensor pre-amp settings
- Variable horizontal readout rate
- Variable vertical shift speed
- Output amplifier selection
- Baseline settings
- Binning and Sub Image settings

These options and an explanation of how to optimize them are explained on **pages 48 - 56**.

3.3.1 - Sensor Pre-amp options

An EMCCD sensor can have a much larger dynamic range than can be faithfully reproduced with the Analogue/Digital converters and signal processing circuitry currently available on the market. To overcome this shortcoming, and to access the range of signals from the smallest to the largest, as well as to optimize the camera performance, it is necessary to allow different pre-amplifier gain settings. However, with regards to selecting something other than the default highest pre-amp (most sensitive) setting for applications, it is recommended that this only ever be carried out when faced with extremely challenging dynamic range concerns. It is very important, however, that for such high-dynamic range applications, the user applies even more care to the amount of EM Gain applied (high EM Gain can drastically reduce the true dynamic range of the camera). Ideally, for maximum dynamic range whilst maintaining improved **Signal to Noise (S/N)**, the EM Gain setting should be set equal to the read noise at the readout speed selected (value obtainable from the performance sheet that comes with the delivered system).

Pre-amplifier gain selection in CCDs is traditionally used to trade off S/N vs dynamic range. A higher pre-amp setting means fewer electrons/count, resulting in a lower system noise floor, therefore a higher S/N. However, high pre-amp settings may not match well to the pixel well depth of the sensor, therefore a lower setting can be selected to meet the full well depth potential, e.g. a pre-amp setting yielding 1.5 e-/count may be selected to ensure that the 65536 digitization levels of a 16-bit A/D are closely matched to a 100,000 e- pixel well depth. A pre-amp setting of 1 e-/count, while giving a lower noise floor, would not harness the full 100,000 e- well depth within the 16 bit A/D.

The situation is not nearly as straightforward for EMCCDs because:

1. EM Gain overcomes readout noise and amplifies signals relative to the digitization noise (which is fixed for a given pre-amp setting).
2. Gain register pixels have a greater well depth than the imaging pixel well depth.

The latter point can be particularly confusing and indeed has led to confusion in the field. What this has meant, is that we have set some of the lower pre-amp settings associated with the EM-output to match the extended well capacity of the gain register pixels (as reported by the sensor manufacturer e2v). This means that these pre-amp settings are designed to be used with EM Gain. Otherwise, the lower well capacity of the imaging pixels will saturate long before the A/D. This is why some users have been confused at not being able to reach the full ~65k counts of the 16-bit A/D channel, when they hadn't applied EM Gain.

Basically, Andor recommends using the default highest value pre-amp setting (e.g. Gain3 setting of the iXon Ultra 897E giving ~ 4 e-/count @ 10MHz) for most low-light applications. Most genuinely low-light applications are not limited by well capacity, as long as sensible EM Gain settings are applied (we recommend not exceeding x500 EM Gain, except for single photon counting experiments). Even at this highest pre-amp setting, the typical imaging pixel well depth will still be exceeded before the 16-bit A/D would saturate ($180,000 \text{ e}^- \div 4 \text{ e}^-/\text{count} = 45,000 \text{ e}^-$). The remainder of the 16-bit A/D range is therefore still free to be utilized by the extended well capacity of the gain register. For example, with an EM Gain of x300 (RealGain™), it would take 600 electrons in a pixel of the sensor to reach this A/D saturation limit. Say the QE is 80% at the wavelength of interest then this corresponds to maximum of 750 photons falling onto that pixel. That is perfectly satisfactory dynamic range for the vast majority of low-light imaging applications.

Note: a Side effect of the new high speed ADC method chosen for the iXon Ultra, is that the full range of ADC codes 0- 65535 is not available. A margin has been added and the iXon will reach an ADC saturation that is lower than 65535. See Camera performance sheet for details.

The core reason for us wishing to recommend this pre-amp setting, even over the middle (Gain2) pre-amp setting, is that it implements an additional restriction as to how much charge is allowed to build up in the sensor. This in turn will help minimize the rate of EM Gain ageing (please see page 42 for further details on measures against gain ageing). However, some applications can be very demanding of dynamic range, and for those we recommend using a lower pre-amp setting such as Gain2. This will ensure the A/D capacity is more closely matched to the well capacity of the gain register pixels, thus affording maximum dynamic range. Also, as mentioned above, to maximize the true dynamic range of the camera we recommend tuning the RealGain™ gain setting to a value close to the value of the readout noise at the selected readout speed (e.g. if readout noise is ~ 50 electrons @ 10 MHz, set the EM Gain to x50 for maximum dynamic range).

3.3.2 - Variable Horizontal Readout Rate

The Horizontal Readout Rate defines the rate at which pixels are read from the shift register. The faster the horizontal readout rate the higher the frame rate that can be achieved. The ability to change the pixel readout speed is important in order to achieve the maximum flexibility of camera operation, particularly in terms of dynamic range. Slower readout typically allows lower read noise and higher available dynamic range, but at the expense of slower frame rates. There are a number of different horizontal readout rates available on the iXon Ultra model. Please refer to the performance sheet for readout rates available on your particular model.

3.3.3 - Variable Vertical Shift Speed

The vertical shift speed is the time taken to vertically shift all pixels one row down, with the bottom row entering the shift register. The ability to vary the vertical shift speed is important for several reasons. It is possible, by using the different vertical speeds, to better synchronize the frame rates to external events such as a confocal spinning disc. Faster vertical shift speeds also have benefits such as lower Clock Induced Charge (CIC). A drawback with faster vertical shift speeds, is that the charge transfer efficiency is reduced, effectively reducing the pixel well depth. This is particularly important for bright signals, as a pixel with a large signal is likely to have some charge left behind if the vertical shift speed is too fast. This will result in degraded spatial resolution.

Slower vertical clocks ensure better charge transfer efficiency, thus giving maximum pixel well depth, but result in a slower maximum frame rate. To improve the transfer efficiency the clocking voltage can be increased using the vertical clock voltage amplitude setting. However, the higher the voltage, the higher the clock-induced charge. Thus the user must make a measured judgement as to which setting works best for their situation. For example:

- **For low CIC:** Use the fastest vertical shift speed that still transfers charge correctly (no image distortion), without having to select excess vertical shift voltage amplitude.
- **For maximum pixel well depth:** Use the slowest vertical shift speed, which will give an increase in CIC.
- **For maximum frame rate:** Use the fastest vertical shift speed and increase the vertical shift voltage amplitude to the minimum value that regains the full pixel well depth.
- **To reduce vertical smearing during very short exposure:** Use a faster vertical shift speed. This vertical smearing is due to the fact that light is still falling on the image area during the short time taken to transfer the charge from the image area into the storage area. If the actual exposure time is of a similar magnitude to this transfer time then as pixels are shifted vertically through brighter regions of the image they will collect “extra” charge which will manifest itself as vertical streaking.

NOTE: For extremely short exposure times, a fast external shutter or pulsed light source may be required.

- **For short exposures (e.g. 1ms):** With high signal count and DC illumination, it may be necessary to increase the vertical clock voltage to ensure that the Keep Clean Cycle can fully remove the extremely high (saturated) signal that may have accumulated during the sensor readout phase.

3.3.4 - Output amplifier selection

The iXon Ultra camera incorporates dual output amplifiers, an electron multiplying output amplifier and a conventional output amplifier. This increases the versatility of the camera as the EM amplifier can be selected for fast imaging in low-light conditions, whilst the conventional amplifier can be selected where more light is available and a slower readout, with its associated lower read noise and higher dynamic range, is preferred.

Figure 16, below, details schematically the readout structure on sensors with both output amplifiers present. From this it can be seen that, when reading out through the EM amplifier, accumulated charge will move to the right along the serial register and then into the EM Gain register. When the conventional output amplifier is selected, the charge to be read out will move along the serial register to the left then be transferred directly into the conventional output amplifier. This change in direction has the effect of producing mirror images when comparing raw data from the two output amplifiers. Some software packages will automatically reverse the image orientation of one of the output amplifiers to allow direct comparison of images. The user should consult his software manual to verify if this is the case.

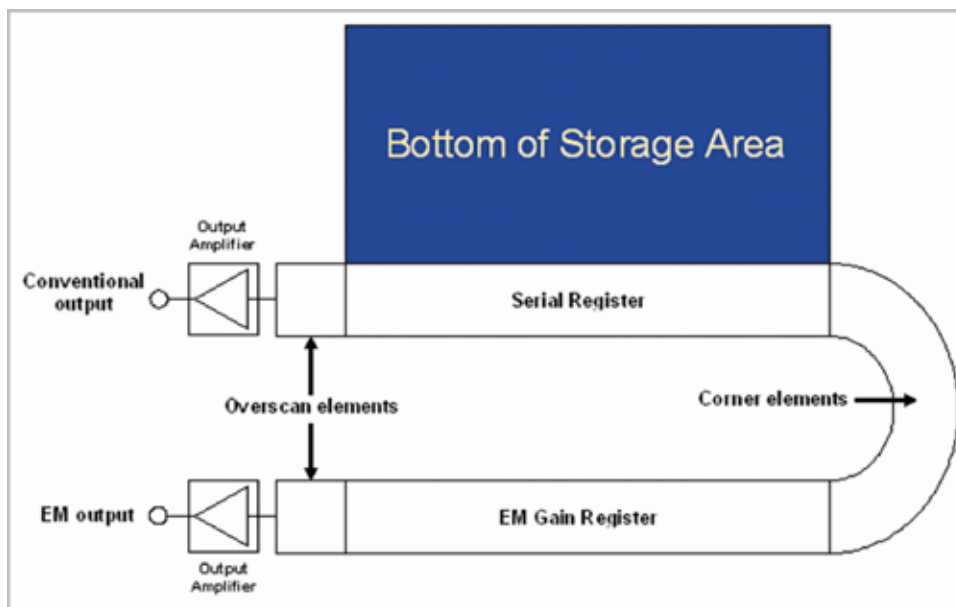

Figure 16: Sensor readout structure

3.3.5 - Baseline Optimization

3.3.5.1 - Baseline Clamp

When acquiring data, small changes in the ambient temperature and/or in the heat generation of the driving electronics within the camera may cause some drift in the baseline level. This is most often observed during long kinetic series. The iXon Ultra series employs a **Baseline Clamp** technique that holds the baseline to a predetermined level. Baseline Clamp corrects each individual image for any baseline drift by subtracting an average bias signal from each image pixel and then adding a fixed count level to ensure that the displayed signal level is always a positive number of counts.

NOTE: Baseline clamp is permanently on during normal operation.

3.3.6 - Binning and Sub Image options

Binning is a process that allows charge from two or more **pixels** to be combined on the **EMCCD**-chip prior to readout. Summing charge on the EMCCD, and doing a single readout, gives better noise performance than reading out several pixels and then summing them in computer memory. This is because each movement of the charge through the readout amplifier contributes to the noise. There are two types of the binning as shown hereunder:

- **Vertical Binning:** Where charge from two or more rows of the EMCCD-chip are moved down into the shift register before the charge is read out. The number of rows shifted depends on the binning pattern selected. Thus, for each column of the EMCCD-chip, charge from two or more vertical elements is **summed** into the corresponding element of the shift register. The charge from each of the pixels in the shift register is then shifted horizontally to the output amplifier and read out.
- **Horizontal Binning:** Where charge from two or more pixels in the serial register are transferred into the output amplifier and read out as one combined data value. Thus the charge from two or more of the horizontal elements is effectively summed into the output amplifier before being readout.

Combining both the vertical and horizontal binning methods produces “Superpixels”. These consist of two or more individual pixels that are binned and read out as one large pixel. Thus the whole CCD, or a selected sub-area, becomes a matrix of Superpixels, e.g.:

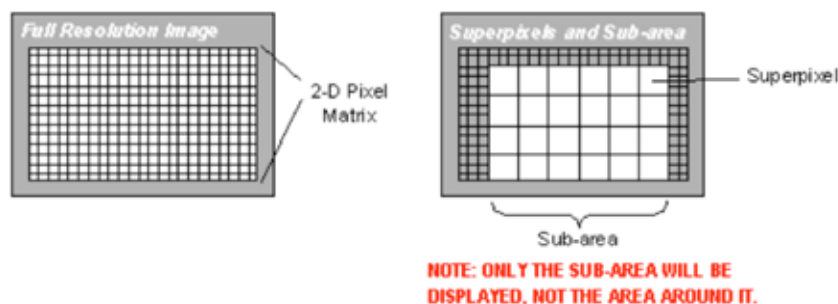

The horizontal and vertical binning parameters determine the dimensions of any superpixels created. On the one hand superpixels result in a loss of spatial resolution when compared to single pixel readout, but on the other hand they offer the advantage of summing data on-chip prior to readout thereby producing a better signal to noise ratio and a higher frame rate. All iXon Ultra models offer completely flexible binning patterns which are user-selectable from software.

For the purpose of initial focusing and alignment of the camera, or to increase the readout speed, the user may wish to only readout a particular sub-area of the CCD to produce a Sub Image.

When a Sub Image has been defined, only data from the selected pixels will be digitized. Data from the remaining pixels will be discarded. The flexible configuration of the iXon Ultra allows the user to set the Sub Image area to any size and location on the CCD chip.

NOTE: Due to the wave shape presented by the sensor at fast clocking speeds, horizontal binning at 17MHz does not give a linear relationship between 1x1 and other horizontal binning options (2x1, 4x1, etc.) Vertical binning is unaffected.

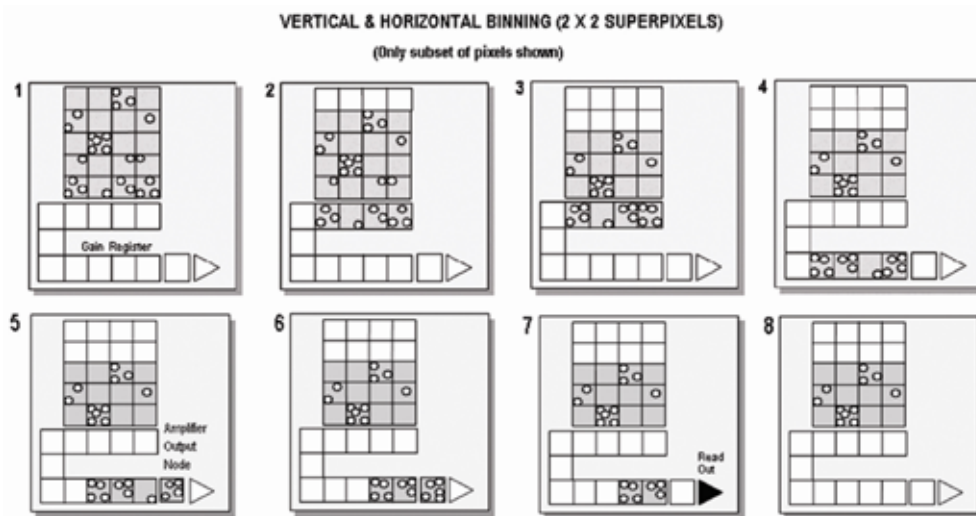

Figure 17: Vertical and Horizontal binning of two rows

- Step 1** Charge is built up on the sensor.
- Step 2** Charge in the frame is shifted vertically by one row, so that the bottom row of charge moves down into the shift register.
- Step 3** Charge in the frame is shifted vertically by a further row, so that the next row of charge moves down into the shift register, which now contains charge from two rows - i.e. the charge is vertically binned.
- Step 4** Charge in the shift register is moved horizontally (through the EM Gain register, if using the EM output amplifier) until the charge from the first data pixel is just about to enter the output node of the amplifier.
- Step 5** Charge in the shift / EM Gain register is moved horizontally by one pixel, so that charge on the endmost pixel of the shift register is transferred into the output node of the amplifier.
- Step 6** Charge in the shift register is again moved horizontally, so that the output node of the amplifier now contains charge from two pixels of the shift register - i.e. the charge has been horizontally binned.
- Step 7** The charge in the output node of the amplifier is passed to the analog-to-digital converter for each row and is read out.
- Step 8** **Steps 5 - 7** are repeated until the shift register is empty. The process is repeated from Step 2 until the whole frame is read out.

3.4 - ACQUISITION OPTIONS

3.4.1 - Capture Sequence in Frame Transfer (FT) Mode

A number of acquisition modes are available for the iXon Ultra range to best suit your experimental demands. In **Frame Transfer (FT)** acquisition mode, the iXon Ultra can deliver its fastest performance whilst maintaining optimal Signal to Noise. It achieves this through simultaneously acquiring an image onto the image area whilst reading out the previous image from the masked frame storage area. Thus there is no time wasted during the readout and the camera operates with what is known as a 100% 'duty cycle'.

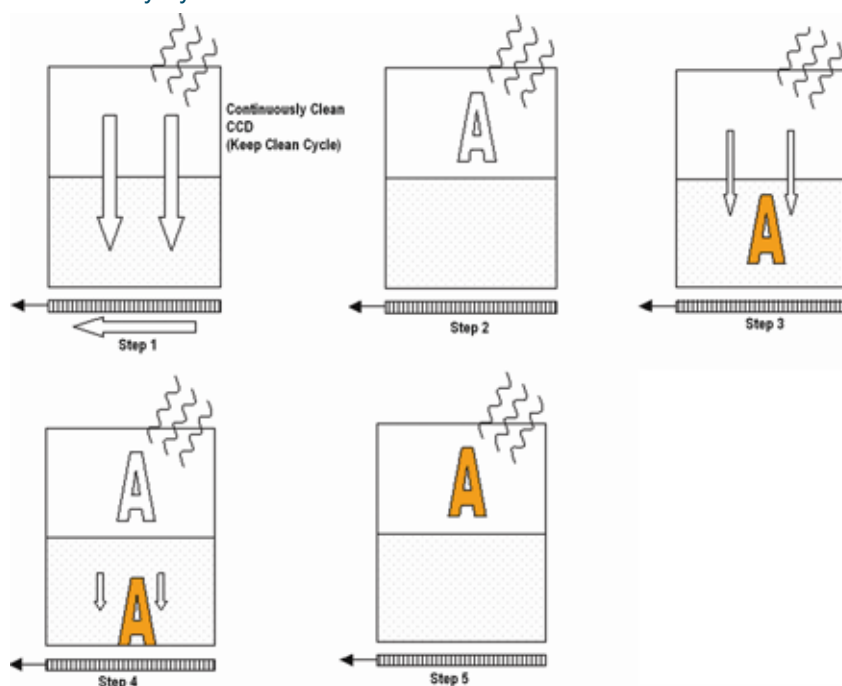

Figure 18: Capture sequence (FT mode)

- Step 1** Both **Image** and **Storage** areas of the CCD are fully cleaned out. This is known as a "Keep Clean Cycle" (KCC). Keep Clean Cycles occur continuously to ensure that the camera is always ready to start an acquisition when required. Further details of the Keep Clean Cycle are given later.
- Step 2** On receipt of a Start acquisition command the CCD stops the Keep Clean Cycle. This allows the image (photoelectric charge) to build up in the Image area of the CCD. The CCD remains in this state until the exposure time has elapsed, at which point the readout process starts.
- Step 3** The first phase of the readout process is to quickly shift the charge, built up in the Image area, into the Storage area. The time required to move the charge into the Storage area is approximately calculated as follows: (No. of rows in the Image area) x (vertical shift rate).
- Step 4** Once the Image area has been shifted into the Storage area the Image area stops vertically shifting and begins to accumulate charge again, i.e. the next exposure starts. While the Image area is accumulating charge the Storage area is being read out. This readout phase can take tens of milliseconds to seconds depending on the image size, readout pattern and readout speed.
- Step 5** On completion of the readout, the system will wait until the exposure time has elapsed before starting the next readout (i.e. returning to Step 3).

3.4.1.1 - Points to consider when using FT Mode

- In this mode, there are no Keep Clean Cycles between images during an accumulation or kinetics series as they are not necessary.
- This mode gives the fastest way to continually take images; however, the minimum exposure time is restricted to the time taken to read out the image from the Storage area.
- The accumulation cycle time and the kinetic cycle time are fully dependent on the exposure time and hence cannot be set via software.
- In external trigger mode there are no Keep Clean Cycles and the External trigger starts the "read out" phase. The exposure time is the time between external triggers and hence the user cannot set the exposure or cycle times. However, the user can define the amount of time between the external trigger event occurring and the readout starting. This can be useful in those situations where the TTL trigger occurs before the light event you are trying to capture. This effectively moves the exposure window in time, but the exposure time is still the period between trigger events.
- There is no need for a mechanical shutter. The exposure time (which is at least equal to the time to readout an entire image) is long compared to the time required to shift the image into the Storage area, and therefore image streaking will be insignificant.

3.4.2 - Capture Sequence in Non-Frame Transfer Mode (NFT) with an FT CCD

It is also possible to operate an FT CCD in a **Non-Frame Transfer (NFT)** mode. In this mode of operation, an FT CCD acts much like a standard CCD. The capture sequence for this mode is illustrated here:

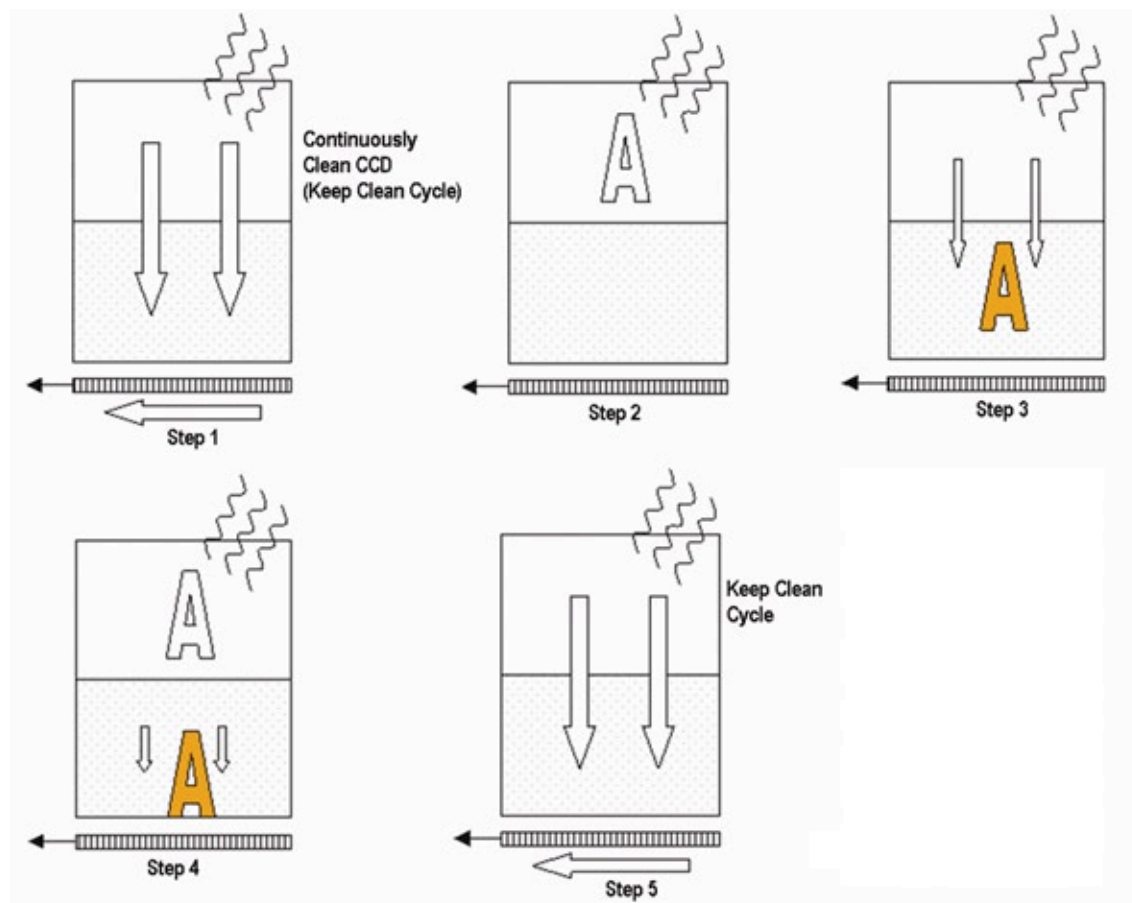

Figure 19: Capture sequence (NFT mode)

- Step 1** Both **Image** and **Storage** areas of the CCD are fully cleared out.
- Step 2** On receipt of a start acquisition command the CCD stops the Keep Clean Cycle and an acquisition begins. The image builds up in the **Image** area of the CCD until the exposure time has elapsed, at which point the readout process starts.
- Step 3** The first phase of this process is to quickly shift the charge built up in the Image area into the **Storage** area. The time required to move the charge into the Storage area is the same as in Frame Transfer mode
- Step 4** With the image now in the Storage area the captured image is read out. The time taken to read out the image is again the same as in the **Frame Transfer** mode.
- Step 5** On completion of the readout, the CCD is completely cleared, ready to acquire the next image. The CCD will remain in the Keep Clean Cycle until the end of the accumulation or kinetic cycle time, depending on the acquisition mode, i.e. back to **Step 1**. As at least one Keep Clean Cycle is performed between each exposure, the minimum exposure time is no longer set by the time to read out the image.

3.4.2.1 - Points to note about using an FT CCD as a standard CCD

- The exposure time, accumulation cycle time and the kinetic cycle time are independent.
- The minimum exposure time is not related to the time taken to read out the image.
- As the captured image is quickly shifted into the Storage area, even in NFT mode, the system can still be used without a mechanical shutter.
- For short exposure times, the image may appear streaked as the time taken to shift the Image area into the Storage area and the exposure time may be of similar magnitude, but much less than a non-frame transfer.
- In conditions where light level falling onto the pixels in the Image area exceeds the pixel well depth of those pixels during the readout of the Storage area image charge blooming can occur vertically along the column contaminating the image being readout.

Example:

During a 100 μ s exposure enough light has fallen on a pixel to register 10000 counts, or 100,000 electrons assuming 10e/count. The image is then shifted into the Storage area. To read out the image, assuming 1,000 x 1,000 pixels, it would take approximately 100ms at 10MHz readout rate. This means that during the reading out of the image 10 million counts (10,000 * 1,000) will have been acquired into the pixel described above. As a pixel saturates at approximately 160,000 electrons this means that the pixel will be over saturated by 60 times. All the excess charge has to go somewhere, and spreads vertically along the CCD column. As the clocks in the Image area are not actively shifting the charge, the mobility of the charge will be low and you may not see any effect. However, when you consider that more than one pixel in any given column could be exposed to 10,000 counts per 100 μ s, the chance of corrupting data is correspondingly increased. Reducing the amount of light falling on the CCD outside of the exposure period and increasing the exposure time accordingly will reduce the possibility of data corruption.

3.4.3 - Capture Sequence for Fast Kinetics (FK) with an FT CCD

Fast Kinetics (FK) is a special readout mode that uses the actual CCD as a temporary storage medium and allows an extremely fast sequence of images to be captured. The capture sequence is illustrated here:

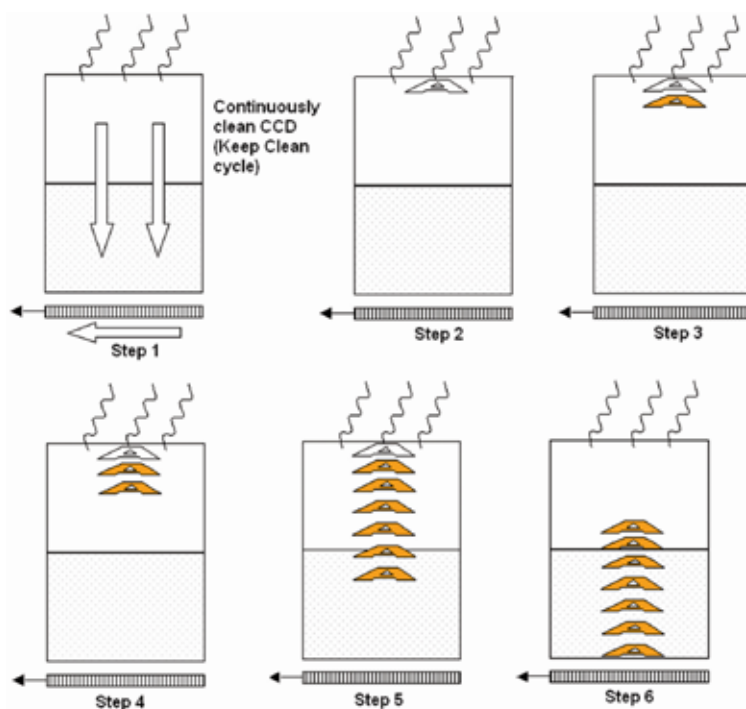

Figure 20: Capture sequence (Fast Kinetics mode)

- Step 1** Both the Image and Storage areas of the CCD are fully cleaned (the Keep Clean Cycle).
- Step 2** The CCD stops the Keep Clean Cycle and the acquisition begins. The image builds up on the illuminated sub-area of the CCD.
- Step 3** The CCD remains in this state until the exposure time has elapsed, at which point the complete CCD is clocked vertically by the number of rows for the sub area of the ccd.
- Steps 4 & 5** The process is continued until the number of images stored equals the series length set by the user.
- Step 6** At this point the sequence moves into the readout phase by first vertically shifting the first image to the bottom row of the CCD. The CCD is then read out in the standard method.

3.4.3.1 - Points to consider when using Fast Kinetics mode

- Light must only be allowed to fall on the specified sub-area. Light falling anywhere else will contaminate the data
- The maximum number of images in the sequence is set by the position of the sub-area, the height of the sub-area and the number of rows in the CCD (Image and Storage area)
- There are no Keep Clean Cycles during the acquisition sequence
- Due to the very short exposure times, streaking may be evident

3.4.4 - Keep Clean Cycles

iXon Ultra cameras have a range of different **Keep Clean Cycles** that are run depending on the actual model and the state the camera is in. The first Keep Clean Cycle to be discussed is the one that runs while the camera is in an idle state, i.e. waiting for the PC to tell it to start an acquisition sequence. We will then look at the Keep Clean Cycle running during an internal trigger kinetics series sequence. Finally, we will look at the Keep Clean Cycle running while the camera is waiting for an external trigger event to occur.

When the camera is idle, i.e. not actively capturing images, it is repeatedly running the **Idle Keep Clean Cycle**. This cycle is composed of a vertical shift, followed by a series of horizontal shifts. The number of horizontal shifts is dependent on the number of elements which make up a row.

When the **Start** command is received from the PC, the camera will complete the current Keep Clean Cycle and then perform a sufficient number of vertical shifts to ensure both **Image** and **Storage** regions are completely charge free, see Figure 21 below. On completion of this sequence the camera is ready to run the exposure sequence. The exact exposure sequence will depend on several factors including the trigger and the readout modes selected. These will be discussed later in this document.

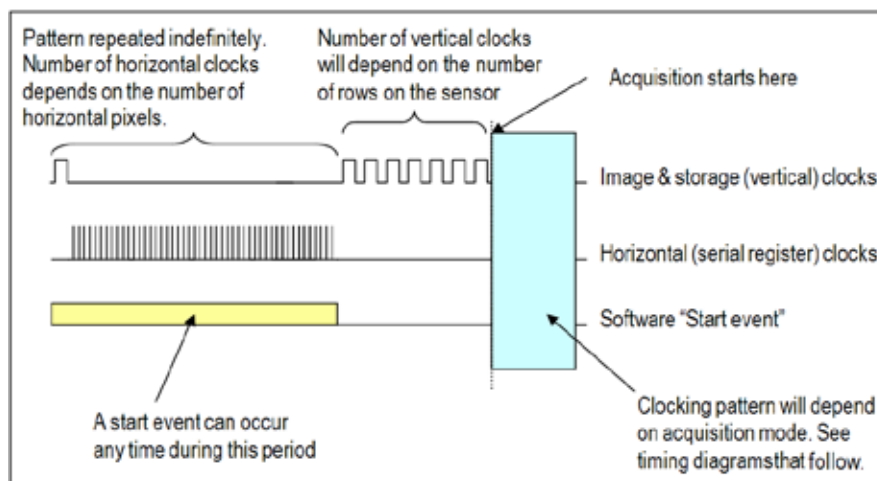

Figure 21: Idle Keep Clean Cycle

The second type of Keep Clean Cycle is executed between individual scans in a kinetic series, and is relevant to Non-Frame Transfer Mode combined with either Internal or Software Trigger. It is called the **Internal Keep Clean Cycle**. When the user configures a kinetics series acquisition, as well as defining the exposure time and the readout mode, they also define the number of scans to capture and the time between the scans. During the time between individual scans the sensor must be kept free of charge to ensure the data captured is a true reflection of the light that fell on it during the exposure period. The Keep Clean Cycle run during this time is very similar to that described in the **Idle Keep Clean Cycle** on the previous page, in that the cycle is one vertical followed by a series of horizontals. In this mode, however, the number of times the cycle is repeated is determined by the cycle time set by the user. The Keep Clean Cycle is completed with a sufficient number of vertical shifts to ensure both the **Image** and **Storage** areas are charge free.

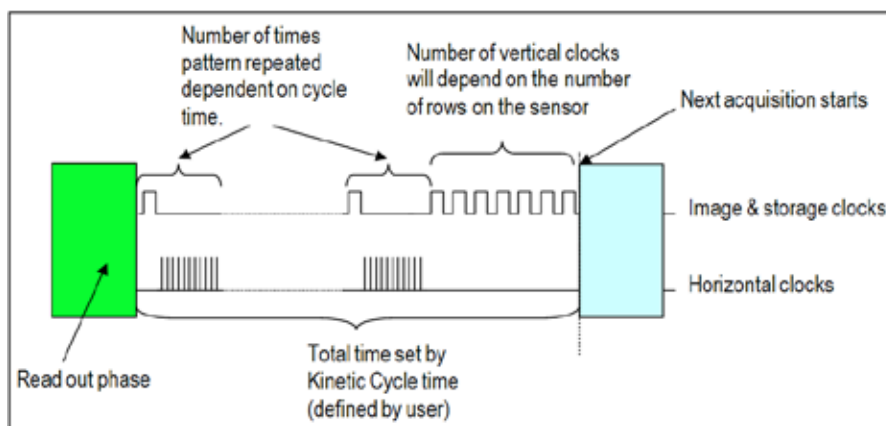

Figure 22: Internal Keep Clean Cycle

The third Keep Clean is the **External Keep Clean Cycle**. This cycle uses a different sequence of horizontal and vertical clocking, as it must be able to respond to external events extremely rapidly but at the same time keep the **Image** area of the sensor charge free. As can be seen from the figure below, the External Keep Clean Cycle consists of a continuous **cycle** of one vertical shift, both Image and Storage, followed by one horizontal shift. When an external trigger is detected the current cycle will complete before the exposure phase starts. It is worth noting that although the **External Keep Clean Cycle** will complete the current cycle, this will not result in the total loss of signal during this time period, as only one vertical shift will have occurred. For pulsed light of very short time duration, microseconds (i.e. of the order of one vertical shift), the resultant image may appear to have shifted one row.

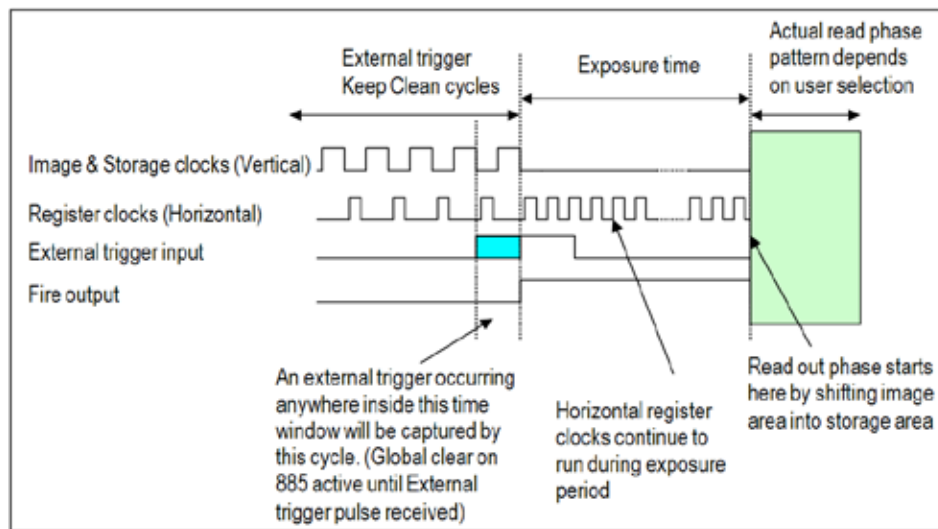

Figure 23: External Trigger Keep Clean Cycle

3.5 - TRIGGERING OPTIONS

The iXon Ultra camera has several different triggering modes. These include **Internal**, **External (and Fast External)**, **External Start**, **External Exposure** and **Software Trigger**. Note also that many of these features require iCam technology within the camera, fuller details of which can be viewed through www.andor.com

- In **Internal Trigger** the camera determines the exact time when an exposure happens, based on the acquisition settings entered by the user. This is the most basic trigger mode and requires no external intervention
- In **External Trigger**, once an acquisition has been started, the camera is placed into a special cleaning cycle called “**External Keep Clean Cycle**”, which ensures that charge built up on the CCD is kept to a minimum while waiting for the external trigger event. The External Keep Clean Cycle consists of a continuous sequence of one vertical shift followed by one horizontal shift. Once the External Trigger is received the current Keep Clean Cycle is completed and the exposure phase initiated. The exact nature of the acquisition will depend on the user settings and is explained in more detail in a subsequent section. The external trigger is fed via the Ext Trig input on the camera head
- **Fast External Trigger** is for the most part identical to External Trigger. It differs in only one key aspect. In Fast External Trigger the camera will not wait for a sufficient number of Keep Clean Cycles to have been completed to ensure the image area is completely clean of charge before accepting an external trigger event but, instead, will allow a trigger event to immediately start the acquisition process. As a result, Fast External trigger allows a higher frame rate than standard External Trigger.

NOTE: Once a “sufficient” number of Keep Cleans Cycles have been performed, External and Fast External Trigger are identical

- **External Start** is a mixture of External and Internal Trigger. In this mode the camera will perform a sequence of External Keep Clean Cycles while waiting for one external trigger event to occur and will then start the acquisition process. Once this external trigger event has occurred, the camera will switch to internal trigger and the acquisition will progress as if the camera was in Internal Trigger mode
- **External Exposure Trigger** is a mode of operation where the exposure time is fully controlled by the external trigger input. While the trigger input is high, the CCD is accumulating charge in the Image area. When the External Trigger goes low, the accumulated charge is quickly shifted into the Storage area and then read out in the normal manner
- **Software Trigger** is a mode whereby the camera and software are in a high state of readiness and can react extremely quickly to a trigger event issued via software. This mode is particularly useful when the user needs to control other equipment between each exposure, and does not know in advance how long such control will take, or if the time taken changes randomly

These modes are explained and illustrated in more detail in the following sections.

3.5.1 - Triggering options in Frame Transfer (FT) mode

3.5.1.1 - Internal Triggering (FT)

This is the simplest mode of operation, in that the camera determines when the exposure happens. By monitoring the **Fire** output, the user can determine exactly when the camera is “**exposing**”.

When the camera is idle, it is running the **Idle Keep Clean Cycle** described previously. On receipt of the Start command from the PC, the camera will complete the current Keep Clean Cycle and then perform sufficient vertical shifts to ensure that the **Image** and **Storage** regions are completely free of charge. The camera then starts its real exposure sequence, for which the timing sequence is illustrated in the figure below.

The first thing to notice is that the **Fire** output is high for much of the time. This is because there are no Keep Clean Cycles running between each acquisition, and hence the exposure time starts on completion of the transfer of the **Image** area into the **Storage** area. This also has the consequence that the exposure time and the cycle time are closely linked. We have defined the exposure time as the time during which there are no vertical shifts occurring, which also corresponds to the time during which the **Fire** output will be high. The other point to note is that the exposure time overlaps the read out of the image.

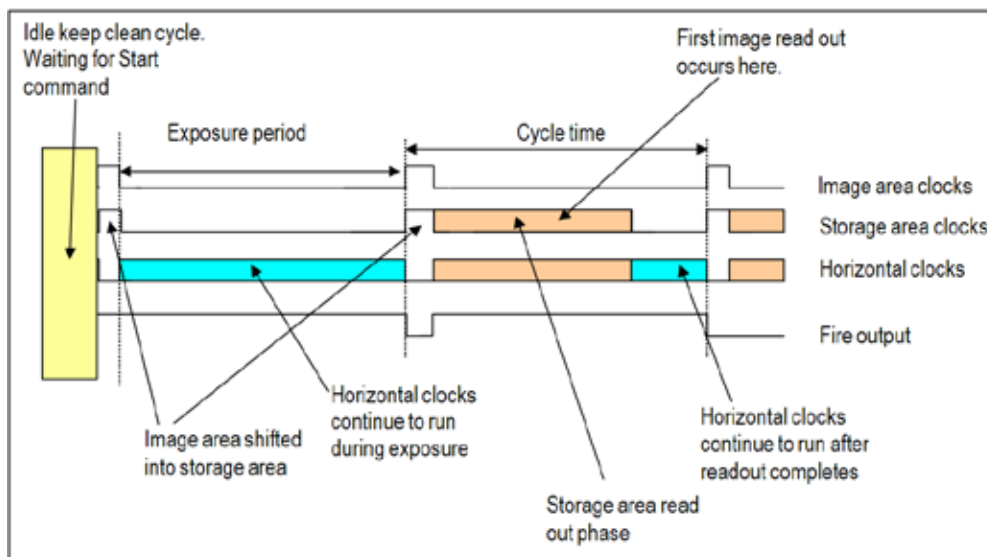

Figure 24: Internal Trigger in Frame Transfer mode

3.5.1.2 - External Triggering (FT)

When the camera is idle, it is running the **Idle Keep Clean Cycle** described previously. On receipt of the Start command from the PC, the camera goes into its **External Keep Clean Cycle**. This cycle consists of one vertical followed by one horizontal shift, repeated continuously. The camera will repeat this cycle **X** times, where **X** is the number of image rows on the sensor, before it will accept any External Trigger events. Once this period is over, the camera will continue running the External Keep Clean Cycle until an External Trigger is received. At that point the current External Keep Clean Cycle is completed, and the camera stops all vertical clocking and waits for the programmed user delay period before starting the read phase. During the readout phase the **Image** area is transferred rapidly to the **Storage** area. The **Storage** area is then read out in the normal way.

Once the readout is complete the camera continues to wait for the next external trigger event. While the camera is waiting for the trigger event, the shift register is continually clocked but the **Image** and **Storage** areas are not. On the next trigger the camera again waits for the programmed delay before starting the readout phase. The camera continues in this cycle until the number of images requested has been captured. Because the Image area is not cleaned between trigger events, the effective exposure time is the time between events. The **User Defined Delay** is to allow for the capture of events which occur after the trigger pulse. In the case of the first trigger, the effective exposure time is given by the User Defined Delay since Keep Clean Cycles have been running up until the first trigger. This is in contrast to the subsequent exposure periods which are defined the time between the external trigger events. Thus, for experimental protocols that involve **Continuous Wave (CW)** light the first image will be dimmer; some protocols may require that this image is discarded.

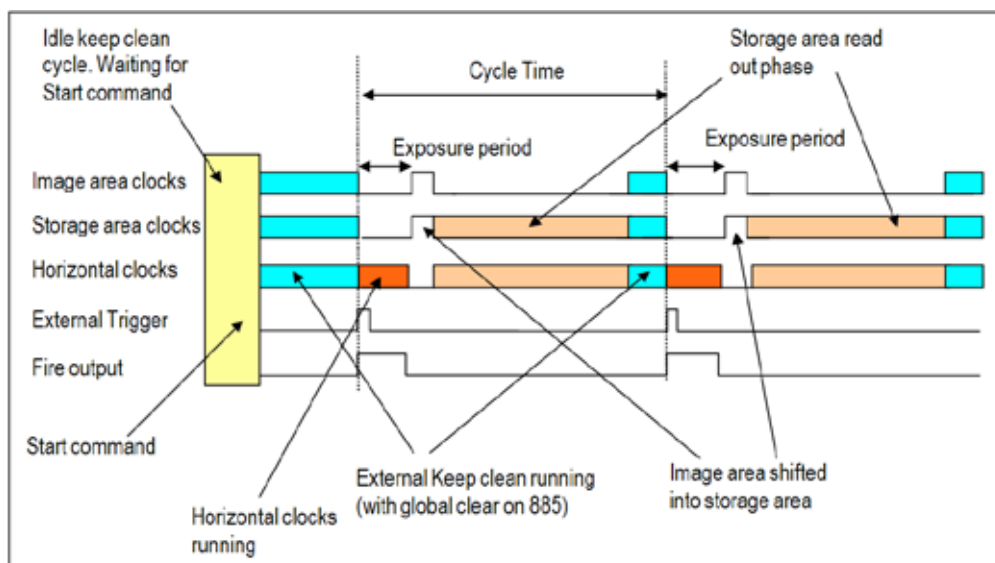

Figure 25: External Trigger in Frame Transfer mode

Since all iXon Ultra cameras have iCam technology, the rising edge of the external trigger can occur before the end of the previous read out, provided that the falling edge of the **Fire** pulse occurs after the readout has completed, i.e. the **External Trigger** is only accepted up to the '**User Defined Delay Period**' before the end of the readout. This enhanced trigger mode will result in a higher frame rate (see **Figure 26** below):

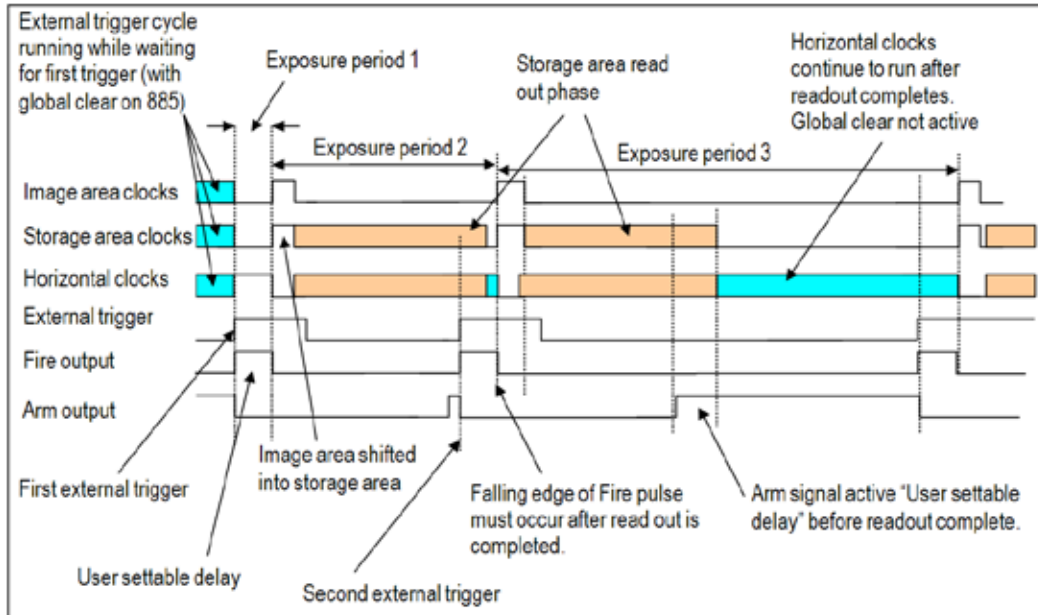

Figure 26: 'iCam-enhanced' External Trigger in Frame Transfer mode

3.5.1.3 - External Exposure (FT)

This mode is distinct from the triggering modes discussed previously, in that the exposure period is fully controlled by the width of the external trigger pulse. The exposure period starts on the positive edge and concludes on the negative edge. As illustrated in the timing diagrams below, the positive edge can occur either after the previous image has been completely read out, or while it is still being read. The ability to overlap the readout with the exposure period allows for very high frame rates. In order to ensure that light falling on the **Image** area before the start of the exposure does not contribute to the measured signal, the CCD is placed in a special keep clean mode. This keep clean mode uses the feature, **Global Clear**. Although the start of the exposure can overlap the read out phase of the previous image, the end of the exposure cannot. This is because the end of the exposure is marked by shifting the **Image** area into the **Storage** area. It is not possible to use the same feature as is used to prevent light that fell before the exposure starts from contributing to the measured signal, as this would cause the already accumulated charge to be cleared.

NOTE: If the falling edge occurs during the read out phase it will be ignored and the next falling edge will terminate the exposure.

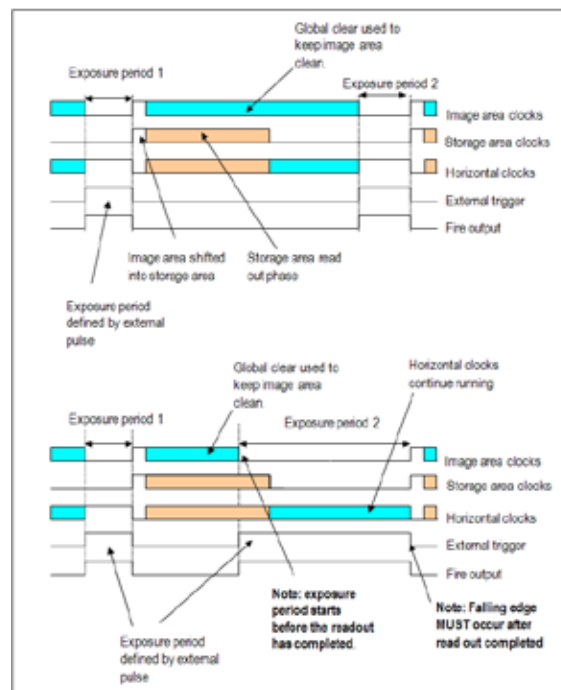

Figure 27: External Exposure Trigger in Frame Transfer mode

3.5.2 - Triggering options in Non-Frame Transfer (NFT) mode

3.5.2.1 - Internal (NFT)

When the camera is idle, i.e. not actively capturing images, it is repeatedly running the Idle Keep Clean Cycle. When the Start command is received from the PC, the camera will complete the **current Keep Clean Cycle**, and then perform sufficient vertical shifts to ensure the **Image** and **Storage** regions are completely free of charge. The camera is now ready to start the real exposure sequence.

The timing sequence is illustrated in the figure below. During the exposure the **Fire** output will be high and there will be no vertical clocking. However, the horizontal register will keep running. At the completion of the exposure time the FIRE pulse will go low and the **Image** area of the CCD will be shifted into the **Storage** area. As the acquired signal is now safely placed in the masked off region of the CCD, light still falling on the CCD will not contaminate the acquired image while it is being read out. On completion of the readout the camera will perform the **Internal Keep Clean Cycle** until the user specified cycle time has elapsed. This process is continued until the complete series of acquisitions has taken place.

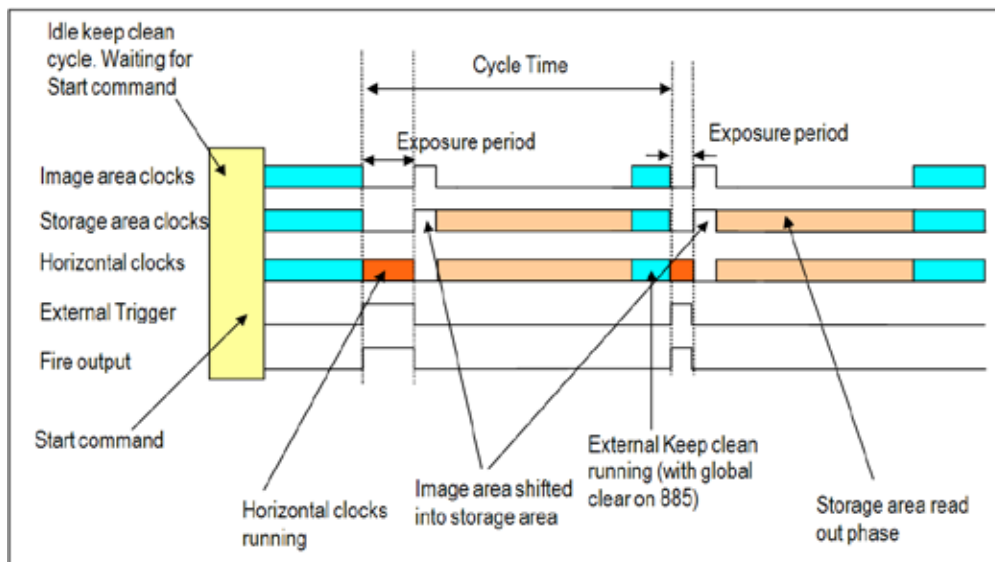

Figure 28: Internal Trigger in Non-Frame Transfer mode

3.5.2.2 - External & Fast External (NFT)

In **External Trigger** modes, once an acquisition has been started, the camera is placed into the special clearing cycle called “**External Trigger Keep Clean**”, which was discussed previously. As can be seen from the figure below, the External Keep Clean Cycle runs continuously until the first external trigger event is detected; at which point the current cycle series will complete before the exposure phase starts. During the exposure there are no vertical clocks running. There will, however, be horizontal clocks to ensure that the shift register continues to be kept clean. Once the exposure time has elapsed the charge built up in the **Image** area is quickly transferred into the **Storage** area. From the **Storage** area the charge is read out as normal. At the completion of the readout the camera restarts the External Keep Clean Cycle.

If the camera is in **Fast External Trigger** mode it will accept a trigger event immediately and start the next exposure. If, however, the camera is in normal external trigger, the camera will perform sufficient **External Keep Clean Cycles** to ensure the **Image** area is fully cleaned before it will accept an external trigger. Once this period has passed, **Normal** and **Fast External Triggers** operate the same.

Fast External Trigger is useful in those cases where there is very little background light and the user is looking for the fastest frame rate. With Fast External Trigger, you may see variation in the background contribution to the signal from light that may have been allowed to fall on the sensor during the readout of the previous image. Fast external trigger does not mean that when a trigger is accepted the system will respond quicker than in normal external trigger mode.

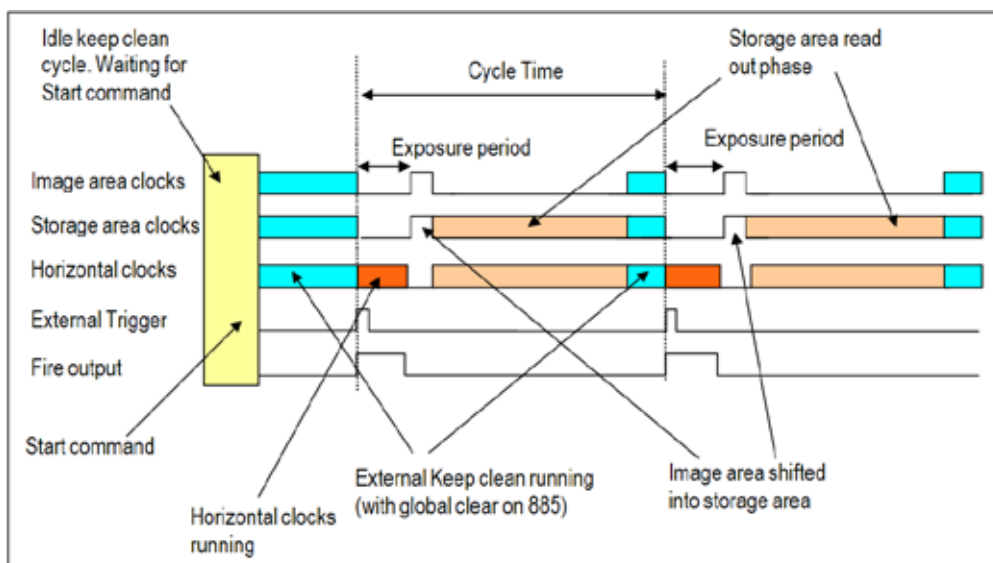

Figure 29: External Trigger in Non-Frame Transfer mode

NOTE: There is no need to worry if the trigger occurs at the early phase of the Keep Clean Cycle, as the light signal will not be lost during the completion of the cycle since only one vertical shift will have occurred. For pulsed light of very short duration (of the order of one vertical shift), the resultant image may appear to have shifted one row.

3.5.2.3 - External Exposure (NFT)

This mode is distinct from the triggering modes discussed previously, in that the exposure period is fully controlled by the width of the external trigger pulse. The exposure period starts on the positive edge and concludes on the negative edge. The exposure is physically ended by shifting the **Image** area into the **Storage** area. The **Storage** area is then readout in the normal manner.

On completion of the readout, the external Keep Clean Cycle is started again.

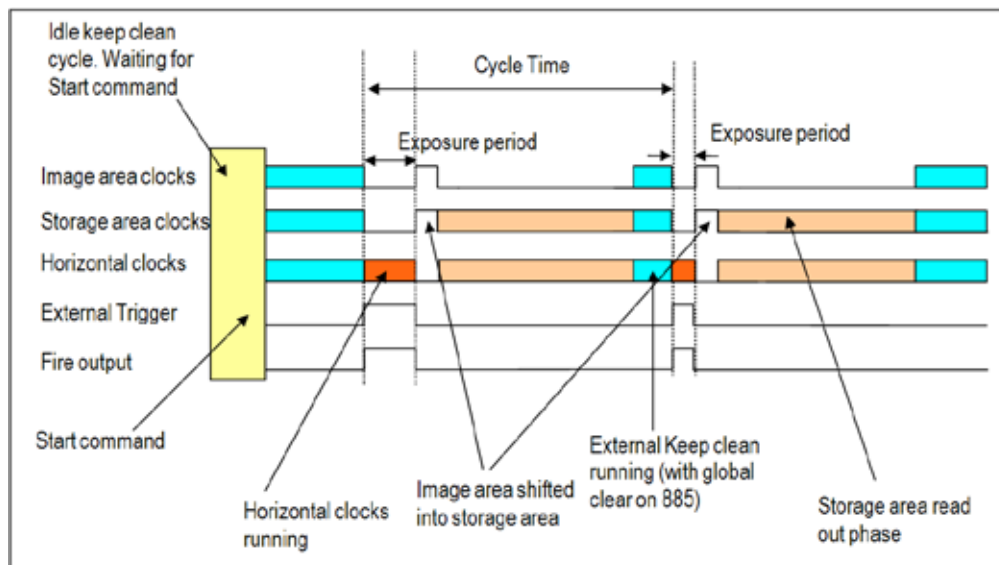

Figure 30: External Exposure Trigger in Non-Frame Transfer mode

3.5.2.4 - Software trigger (NFT)

This mode is particularly useful when the user needs to control other equipment between each exposure and does not know in advance how long such control will take, or if the time taken changes randomly. With **Software Trigger**, the camera and software are in a high state of readiness and can react extremely quickly to a trigger event issued via software.

In this mode the camera will run the Idle **Keep Clean Cycle** until the Start command is issued by the PC, which is identical to all the modes previously discussed. On receipt of this command the camera will switch to running the normal Internal **Keep Clean Cycle** until a **Software Trigger** command is issued by the PC. This event will start the exposure and readout sequence. On completion of the readout the camera will return to the Internal **Keep Clean Cycle** until the next **Software Trigger** is issued.

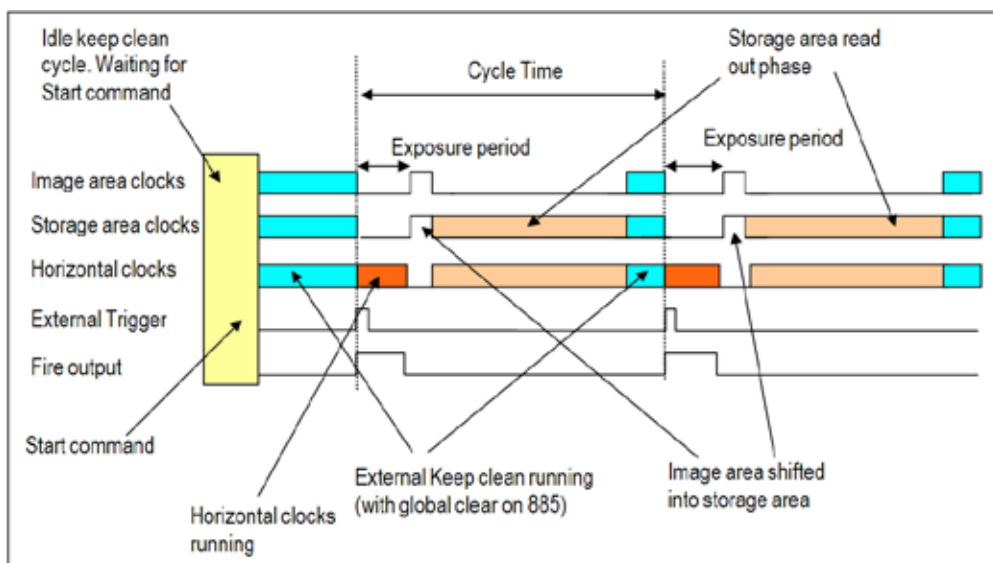

Figure 31: Software Trigger in Non-Frame Transfer Mode

3.5.3 - Trigger options in Fast Kinetics (FK) mode

3.5.3.1 - Internal (FK)

As Fast Kinetics uses both the **Image** and **Storage** areas as temporary storage areas, the number of options available is quite limited. The simplest mode is again Internal Trigger and, as with the internal trigger modes described previously, the system determines when the acquisition begins and then uses the exposure time defined by the user. On completion of the exposure period the camera performs the number of vertical shifts defined by the user, and then again waits for the exposure period before the next set of vertical shifts.

This process is repeated until the number in the series has been captured, at which point the readout starts. The timing sequence is shown below and as before the **Fire** output envelopes the period when no vertical clocking is occurring. You will also see there are no readout cycles or Keep Clean Cycles running during the sequence, hence the very fast kinetic cycle period but limited number of exposures in the series.

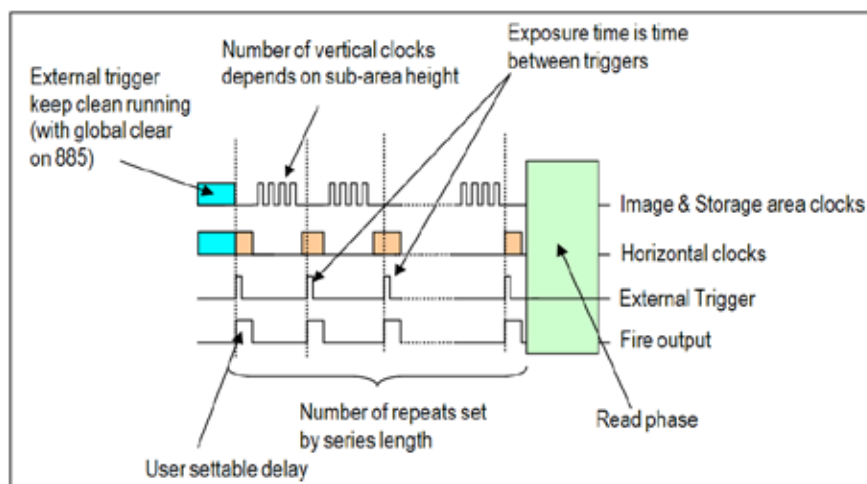

Figure 32: Internal Trigger in Fast Kinetics mode

3.5.3.2 - External (FK)

In **External Trigger** mode, a trigger pulse is required to start each scan in the series. The rising edge of the trigger defines the trigger event. The user can delay the start of the vertical shifting relative to the trigger event. After the delay has elapsed, the number of rows (as specified by the user) are vertically shifted. The system then waits for the next trigger to start the next scan. As there is no Keep Clean Cycle running while waiting for the External Trigger, the **'real'** exposure time is the time between each trigger. A consequence of this is that, if your experiment has a constant background signal but your trigger period is not fixed, you may see different background levels in your signal. As with internal trigger, the data is only read off the sensor when the capture sequence has completed.

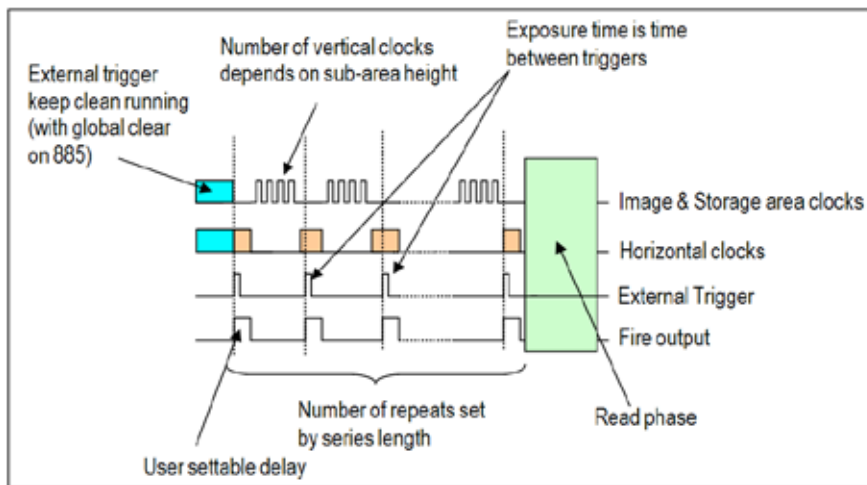

Figure 33: External Trigger in Fast Kinetics mode

3.5.3.3 - External Start (FK)

External Start trigger mode is a combination of External and Internal Trigger. At the start of the capture process, the camera is running the External Keep Clean Cycle waiting for a trigger pulse to be applied to the External Trigger input. On receiving the trigger the exposure starts. The exposure period is defined by the user. On completion of the exposure period, the camera performs the number of vertical shifts defined by the sub-area height (set by the user) and, then again, waits for the exposure period before the next set of vertical shifts. This process is repeated until the number in the series has been captured at which point the readout starts.

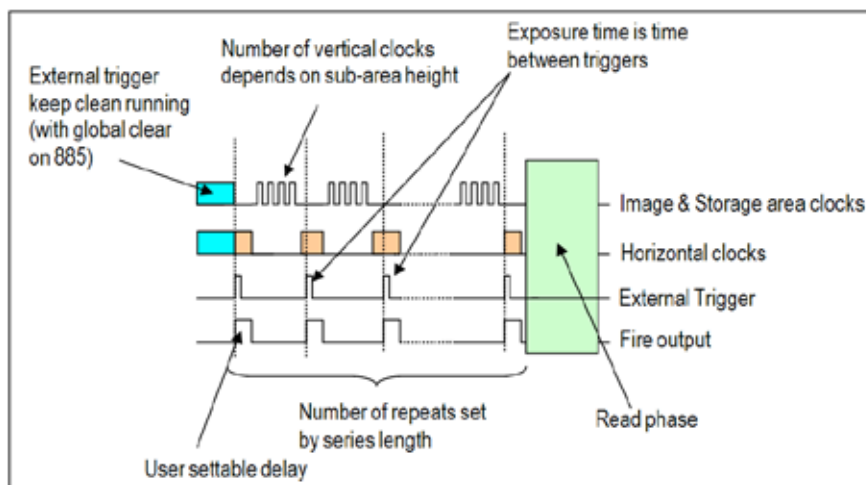

Figure 34: External Start trigger in Fast Kinetics mode

3.6 - SHUTTERING

The iXon Ultra camera is supplied with a built in bi-stable shutter. This bi-stable shutter requires no power to maintain the open or closed state - so it is well suited to long exposures. The bi-stable shutter also has a longer theoretical life because of the lower energy levels used. The shutter is intended for taking background images and protecting the camera from excessive light and dust. It is not designed to operate at the high frame rates the camera is capable of. Under normal operation, the shutter should be set to **Permanently Open** and the shutter open and close times to 0 seconds. If you do need the shutter to open and close automatically during your experiment, then set the opening and closing times to 27 mS.

The maximum continuous operation of the shutter is 2Hz.

NOTE: If the camera is powered down before the software is closed, the shutter could be left in an open position. This is design intent and the shutter will return to the closed position when next commanded to by the software. If the software is exited normally, the shutter will be automatically closed.

3.7 - COUNT CONVERT

One of the distinctive features of the iXon Ultra is the capability to quantitatively capture and present data in units of electrons or photons; the conversion applied either in real time or as a post-conversion step. Photons that are incident on pixels of an array detector are captured and converted to electrons. During a given exposure time, the signal in electrons that is collected in each pixel is proportional to the signal intensity. In EMCCDs, the signal in electrons is further multiplied in the EM Gain register. The average multiplication factor is selected in the software from the RealGain™ scale. It can be desirable to directly quantify signal intensity either in terms of electrons per pixel, or in terms of incident photons per pixel. However, during the readout process, array detectors must first convert the signal in electrons (the multiplied signal in the case of EMCCDs) into a voltage, which is then digitized by an Analogue to Digital Converter (ADC). Each Analogue to Digital Unit (ADU) is presented as a ‘count’ in the signal intensity scale, each count corresponding to an exact number of electrons. Furthermore, the signal value in counts will sit on top of an electronic bias offset value. In the iXon Ultra this ‘baseline’ is clamped at 200 counts in normal operation modes.

Therefore, in order to back calculate to the original signal in electrons, the electron to ADU conversion factor must be very accurately stored by the camera (which varies depending on the pre-amplifier gain selection chosen through software). Calculation of the signal as absolute electrons also requires knowledge of the bias offset and the EM Gain. The calculation path is shown in **Figure 35** below:

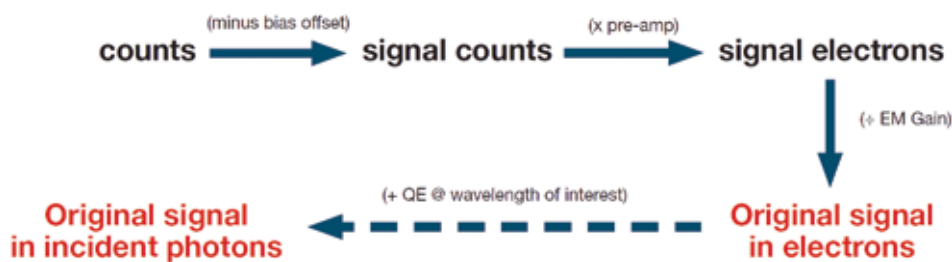

Figure 35: Count Convert calculation path

Furthermore, knowledge of the Quantum Efficiency (QE) at each wavelength, and light throughput properties of the camera window, enables this process to be taken a step further allowing the signal to be estimated in photons incident at each pixel. For this step, the user must input the signal wavelength. In fluorescence microscopy, for example, this would correspond to the central wavelength defined by a narrow band emission filter matched to the fluorophore of interest. If the spectral coverage of the signal on the detector is too broad so that the QE curve varies significantly throughout this range, then the accuracy of the incident photon estimation would be compromised.

The Count Convert functionality of the iXon Ultra provides the flexibility to acquire data in either electrons or incident photons, using both real time and post-process facilities. Since the real time feature is processed in hardware, there is little or no impact on the display rate. With the post-process option, it is possible to record the original data in counts and perform this important conversion to either electrons or photons as a post-conversion step, while retaining the original data.

3.8 - OPTACQUIRE

OptAcquire is a unique control interface, whereby a user can conveniently choose from a predetermined list of set-up configurations, each designed to optimize the camera for different experimental acquisition types, thus removing complexity from the extremely adaptable control architecture of the iXon Ultra. The control architecture of the iXon Ultra is extremely tuneable, meaning the camera can be adapted and optimized for a wide variety of quantitative experimental requirements, ranging from fast single photon counting through to slower scan, 16-bit dynamic range measurements. However, successfully optimizing EMCCD technology is not a trivial exercise, with various set-up parameters directly influencing different camera performance characteristics.

OptAcquire has been designed as a unique interface whereby a user can choose from a predetermined list of eleven camera set-up configurations. A variety of set-up parameters are balanced behind the scenes through the OptAcquire menu. Furthermore, advanced users may wish to create their own additional OptAcquire configuration. iXon Ultra control parameters include:

- **EM Gain** – This parameter has a direct bearing on both sensitivity and dynamic range.
- **Vertical clock speed** – Flexibility in this parameter is critical to optimizing the camera for lowest noise, fastest speed, minimal frame transfer smear or maximum pixel well depth.
- **Vertical Clock Amplitude** – Can be used to compensate charge transfer when the sensor is being ‘over-clocked’ and also to reduce charge leakage into the image area when there is saturated signal in the frame transfer storage area (e.g. when combining very short exposure with a slow readout speed).
- **Horizontal readout speed** – Ranging between 17 MHz and 0.08MHz. 17MHz for faster frame rates, 0.08MHz for best dynamic range.
- **Pre-amplifier gain** – Trading off reduced digitization noise versus accessing full pixel well depth.
- **EM / Conventional amplifier** – To choose between ultra-sensitive EMCCD operation or traditional high dynamic range CCD operation, the latter recommended for relatively ‘brighter’ signals or when it is possible to apply long exposures to overcome read noise floor.
- **Frame Transfer (overlap)** – Overlapped readout is used to achieve 100% duty cycle, ideal for fastest frame rate measurements without switching exposure time between frames. This mode should be deselected for time-lapse experiments.

3.8.1 - OptAcquire modes

Pre-defined OptAcquire modes include:

Sensitivity and Speed (EM Amplifier)	Optimized for capturing weak signal at fast frame rates with single photon sensitivity. Suited to the majority of EMCCD applications.
Dynamic Range and Speed (EM Amplifier)	Configured to deliver optimal dynamic range at moderately fast frame rates. Moderate EM Gain applied.
Fastest Frame Rate (EM amplifier)	For when it's all about speed! Optimized for absolute fastest frame rates of the camera. Especially effective when combined with sub-array/binning selections.
Time Lapse (EM Amplifier)	Configured to capture low-light images with time intervals between exposures. Overlap ("frame transfer") readout is deactivated.
Time Lapse and Short Exposures (EM Amplifier)	Configured to minimize vertical smear when using exposure < 3ms.
EMCCD Highest Dynamic Range (EM amplifier)	Combines EMCCD low-light detection with the absolute highest dynamic range that the camera can deliver. Since this requires slower readout, frame rate is sacrificed.
CCD Lowest Noise / Slow readout (Conventional Amplifier)	Optimized for slow scan CCD detection with lowest noise floor. Recommended for long exposure applications where slow readout can be tolerated.
CCD Highest Dynamic Range (Conventional Amplifier)	Optimized for slow scan CCD detection with highest available dynamic range. Recommended for brighter signals OR when it is possible to apply long exposures to overcome noise floor.
CCD noise / readout balance (Conventional Amplifier)	Optimized for slow scan CCD detection, achieving a balance between noise floor and readout time.
Photon Counting	Configuration recommended for photon counting with individual exposures < 10sec.
Photon Counting with Long Exposures (> 10 sec)	Configuration recommended for photon counting with individual exposures > 10sec.

3.9 - PUSHING FRAME RATES WITH CROPPED SENSOR MODE

The iXon Ultra offers Cropped Sensor Mode, which carries the following advantages:

- Specialized readout mode for achieving very fast frame rates (sub-millisecond exposures) from ‘standard’ cameras
- Continuous rapid spooling of images/spectra to hard disk
- User selectable cropped sensor size – highly intuitive software definition
- The iXon Ultra is now available with the complementary OptoMask accessory, which can be used to shield the region of the sensor outside of the cropped area

If an experiment demands fast temporal resolution but cannot be constrained by the maximum storage size of the sensor (as is the case for ‘Fast Kinetics Mode’ of readout), then it is possible to readout the iXon Ultra in ‘Cropped Sensor Mode’. In this mode, the user defines a ‘sub-array’ size from within the full image sensor area, such that it encompasses the region of the image where change is rapidly occurring (e.g. a ‘calcium spark’ within a cell). The sensor subsequently “imagines” that it is of this smaller defined array size, achieved through software executing special readout patterns, and reads out at a proportionally faster frame rate. The smaller the defined array size, the faster the frame rate achievable.

In order to use Cropped Sensor mode, one has to ensure that no light is falling on the light sensitive area outside of the defined region. Any light collected outside the cropped area could corrupt the images which were acquired in this mode. For microscopy set-ups this is now aided with an accessory called OptoMask, which is available from Andor.

Cropped Sensor Mode has the end result of achieving a much faster frame rate than that obtainable in a conventional ‘sub-array’ / ROI readout (during which we would still have to vertically shift the unwanted rows). The frame rate increase is achieved by not reading out (i.e. discarding) the unwanted pixels.

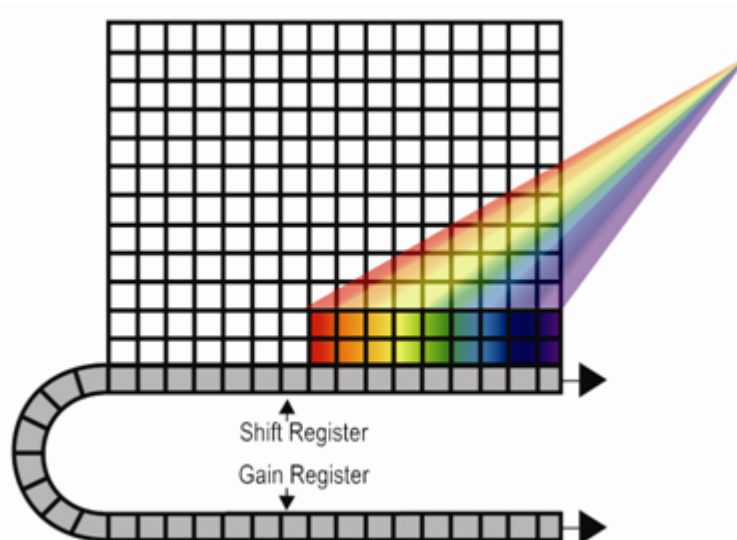

Figure 36: Cropped Sensor Mode.

The active imaging area of the sensor is defined in such a way that only a small section of the entire chip is used for imaging. The remaining area has to be optically masked to prevent light leakage and charge spill-over that would compromise the signal from the imaging area. By cropping the sensor one achieves faster frame rates because the temporal resolution will be dictated by the time it requires to read out small section of the sensor.

3.9.1 - Cropped Sensor Mode Frame Rates

In biological imaging, Cropped Sensor Mode can be successfully used to enhance performance, and throughput, in super-resolution ‘nanoscopic’ applications including STORM and PALMIRA.

Imaging frame rates exceeding 1,000/s can be achieved with a sufficiently small crop area. A series of measurements carried out on the Andor iXon Ultra 897 EMCCD camera, has demonstrated that Cropped Sensor Mode, in conjunction with binning, pushed the speed beyond 4,000 frames per second.

The table below shows the Imaging frame rate potential of the Andor iXon Ultra 897 EMCCD camera under conditions of Cropped Sensor Mode readout:

Crop Mode

BINNING	256 x 256	128 x 128	64 x 64	32 x 32	512 x 100	512 x 32	512 x 1
1 x 1	111	595	1,433	3,534	282	858	11,074
2 x 2	215	1,085	2,433	5,328	539	1,589	
3 x 3	402	1,803	3,578	6,579	982	2,682	
4 x 4	699	2,532	4,211	6,146		3,727	

Standard Mode

BINNING	512 x 512	256 x 256	128 x 128	64 x 64	512 x 100	512 x 32	512 x 1
1 x 1	55.8	110	212	397	266	704	2,778
2 x 2	109	210	392	694	485	1,136	
4 x 4	206	385	680	1,099	813	1,587	
8 x 8	369	645	1,042	1,493		1,923	

EMCCD-based adaptive optics, for which smaller format EMCCD sensors are often used, can benefit from cropped sensor readout. EMCCDs can be flexibly optimized in cropped mode to exceed 2,000 fps. Use of cropped sensor mode opens new possibilities for very fast adaptive optics imaging, enabling the users to reach into several thousands of frames per second.

There is also potential to use cropped EMCCDs for multi-spectral fluorescence confocal scanning, as an alternative to the arrays of PMTs that have traditionally been used in this approach. The > 90% quantum efficiency of the back-illuminated sensor, single photon sensitivity, array architecture and rapid pixel readout speed can be exploited to markedly improve this approach. The laser dwell-time should be set to coincide with the time to expose and readout a short row of approximately 32 pixels - sufficient spectral channels to yield effective un-mixing of several known emitting dyes, resulting in a data cube of 512 x 512 x 32 (spectral), and taking less than 1 second to generate. There is a clear sensitivity advantage of EMCCD pixels over the usually employed PMT-technology, which is circa 5-fold in the blue-green and up to tenfold in the red.

3.10 - ADVANCED PHOTON COUNTING IN EMCCDS

Photon Counting in EMCCDs is a way to overcome the multiplicative noise associated with the amplification process, thereby increasing the signal to noise ratio by a factor of root 2 (and doubling the effective quantum efficiency of the EMCCD). Only EMCCDs with low noise floor can perform photon counting. The approach can be further enhanced through innovative ways to post process kinetic data. The industry-leading dark current and Clock Induced Charge (CIC) specification of the Andor's back-illuminated iXon Ultra 897 model renders it uniquely suited to imaging by Photon Counting.

Photon Counting can only be successfully carried out with very weak signals because, as the name suggests, it involves counting only single photons per pixel. If more than one photon falls on a pixel during the exposure, an EMCCD (or an ICCD for that matter) cannot distinguish the resulting signal spike from that of a single photon event, and thus the dynamic range of a single frame exposure is restricted to one photon.

Key Fact – To successfully photon count with EMCCDs, there has to be a significantly higher probability of seeing a 'photon spike' than seeing a dark current / CIC 'noise spike'. The iXon Ultra 897 has the lowest dark current / CIC performance on the market, yielding both lower detection limits and higher contrast images.

Under such ultra low-light conditions, 'photon counting mode' imaging carries the key benefit that it is a means to circumvent the Multiplicative Noise (also known as 'Noise Factor'). Multiplicative Noise is a by-product of the Electron Multiplication process and affects both EMCCDs and ICCDs. In fact, it has been measured to be significantly higher in ICCDs. The noise factor of EMCCDs is well theorized and measured; to account for it you increase the shot noise of the signal by a factor of square root 2 (~x1.41). This gives the new 'effective shot noise' that has been corrected for multiplicative noise. The effect of this additional noise source on the overall Signal to Noise ratio can be readily viewed in the S/N plots in the technical note entitled 'EMCCD signal to noise plots'.

Photon Counting Mode does not measure the exact intensity of a single photon spike, it merely registers its presence above a threshold value. It does this for a succession of exposures and combines the individual 'binary' images to create the final image. As such, this mode of operation is not affected by the multiplication noise (which otherwise describes the distribution of multiplication values around the mean multiplication factor chosen). The end result is that low-light images, acquired through this mode of acquisition, are improved by a factor of ~x1.41 Signal to Noise, compared to a single integrated image with the same overall exposure time.

To successfully photon count with EMCCDs, there has to be a significantly higher probability of seeing a ‘photon spike’ than of seeing a dark current / CIC ‘noise spike’. The lower the contribution of this ‘spurious’ noise source to a single exposure within the accumulated series, the lower the detection limit of photon counting and the cleaner the overall image will be, as demonstrated in **Figure 37** below:

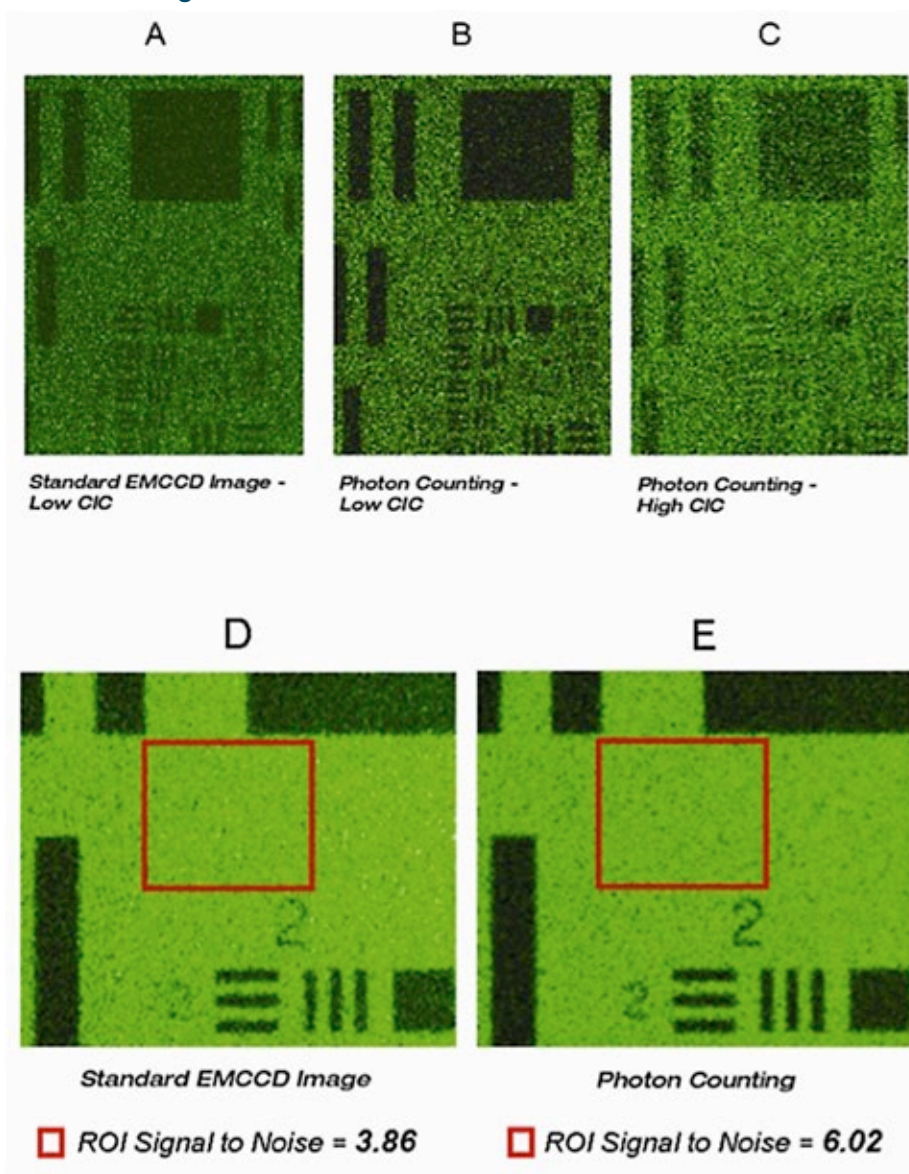

Figure 37: ‘Photon Counting’ vs. ‘Standard EM-on’ Imaging for very weak signals.

Images A, B and C were recorded under identical illumination conditions, identical exposure times and each with EM Gain set at x1,000. The benefit of photon counting under conditions of low clock induced charge (CIC) is evident. Images D and E are derived from a larger number of accumulated images, in order to yield a greater measurable Signal to Noise ratio. An identically positioned Region of Interest on each image was used to determine S/N of 3.86 and 6.02 for standard and photon counted images respectively. This factor improvement is in accordance with the theory of Photon Counting circumventing the influence of multiplicative noise (noise factor) in EMCCD signals.

3.10.1 - Photon Counting by Post-Processing

As a post-processing analysis, the user holds the flexibility to ‘trial and error’ photon counting a pre-recorded kinetic series, trading-off temporal resolution vs SNR by choosing how many images should contribute to each photon counted accumulated image.

For example, a series of 1,000 images could be broken down into groups of 20 photon counted images, yielding 50 time points. If it transpires that better SNR is required, the original dataset could be re-treated using groups of 50 photon counted images, yielding 20 time points.

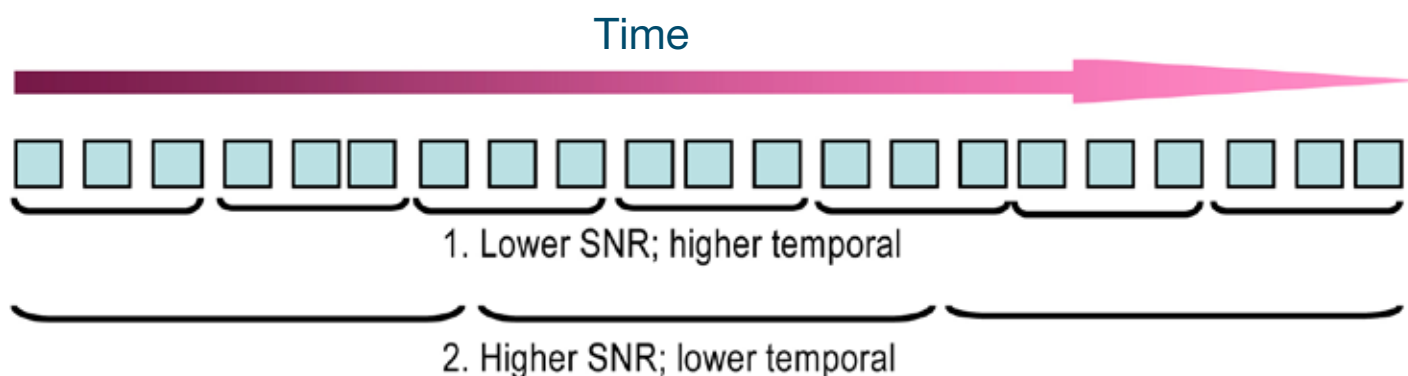

Figure 38: Schematic illustration of how photon counting can be applied to a kinetic series as a post processing step, affording increased flexibility in ‘trial and error’ trading temporal resolution vs SNR.

3.11 - SPURIOUS NOISE FILTER

It can be desirable to optionally filter spurious EM-amplified background events to give as ‘black’ a background as possible, eradicating any remaining ‘salt and pepper’ noise. It is important to utilize noise selection and filter algorithms that are intelligent enough to accomplish this task without impacting the integrity of the signal itself. This is realized through the new Spurious Noise Filter (SNF) functionality of iXon Ultra, which offers the user a choice of advanced algorithms to try. SNF can be applied either in real time or as a post-processing step. Like the count convert option, the real time processing of the filters is performed in hardware, thereby providing minimal impact on the display rate. The options available to the user for using Spurious Noise filter are as shown hereunder:

- Median (available in Real Time & Post-Processing)
- Level Above (available in Real Time & Post-Processing)
- Interquartile Range (available in Real Time & Post-Processing)
- Noise Threshold (available in Post-Processing)

These can be selected from the **Real Time** or **Post Process** options, e.g.

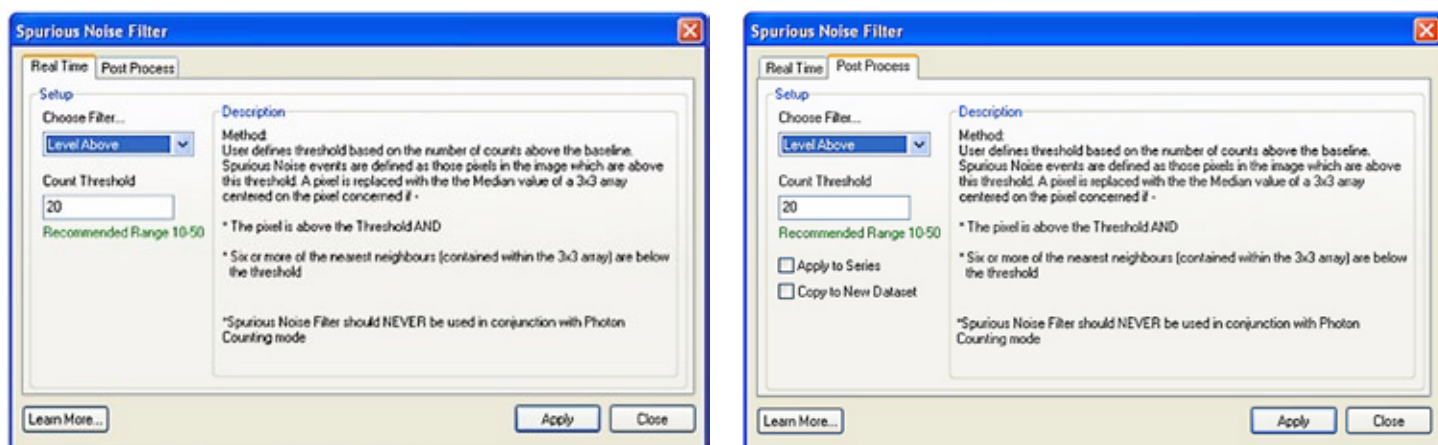

NOTE: Andor spurious noise filters’ options make use of advanced algorithms that offer excellent discrimination of spurious noise events with minimal effect on signal integrity.

SECTION 4: HARDWARE

4.1 - EMCCD TECHNOLOGY

4.1.1 - What is an Electron Multiplying CCD?

Current trends in photonics are placing unprecedented demands on detector technology to perform at significantly greater levels of sensitivity and / or speed. **Electron Multiplying Charge Coupled Device (EMCCD)** technology has been designed to respond to this growing need and, in turn, is opening up new avenues of novel experimental design.

EMCCD technology, sometimes known as “on-chip multiplication”, is an innovation first introduced to the digital scientific imaging community by Andor Technology in 2000, with the launch of our dedicated, high-end iXon platform of ultra-sensitive cameras. Essentially, the EMCCD is an image sensor that is capable of detecting single photon events without an image intensifier (achievable by way of a unique electron multiplying structure built into the chip).

It is readily adjustable in real time through the software, where extremely weak signals may be detected above the read noise of the camera at any readout speed. This is important, because the traditional problem of combining sensitivity with speed in standard CCDs is that the two are mutually exclusive, i.e. greater read noise detection limits result from faster pixel readout.

4.1.2 - Does EMCCD technology eliminate Read Out Noise?

System noise within modern silicon based detectors has two primary sources: dark current noise and read noise. The higher the noise floor on a detector the less able it is to read out the extremely weak signals associated with ultra low-light imaging.

With thermoelectric cooling, dark current noise can be reduced to negligible levels. An EMCCD’s ability to multiply weak signals above the detector’s read noise floor, by applying EM Gain, effectively eliminates read noise at any speed by reducing it to < 1 e-/p/s.

4.1.3 - How sensitive are EMCCDs?

Two parameters significantly influence detector sensitivity, namely Quantum Efficiency (QE) and system noise. QE is a measure of a camera’s ability to capture valuable photons. A high QE results in more photons being converted to photoelectrons within the CCD pixels.

Once converted, the photoelectrons in a given pixel must overcome the detection limit or noise floor of the camera, which is set by the system noise. EMCCDs deliver superior sensitivity by maximizing QE and minimizing system noise, through the unique gain control feature. Single photon events are now well within the capabilities of super sensitive EMCCD technology.

4.1.4 - What applications are EMCCDs suitable for?

EMCCD based detectors have been designed for the most demanding of low-light, dynamic applications. These detectors have redefined the sensitivity expectations of scientific grade cameras, with a detection limit as low as single photons.

These levels of sensitivity are vital for low-light, life science and physical science imaging applications such as single molecule detection, live cell microscopy, weak luminescence detection, or demanding astronomy applications (to name only a few).

4.1.5 - What is Andor Technology's experience with EMCCDs?

Andor Technology was the first company to introduce an EMCCD based detector in 2000. Since then the company has led the way in the development of EMCCD detectors, introducing the first back illuminated EMCCD in January 2003. Andor now offers the widest range of EMCCD based detectors on the market. The company is also playing a pivotal role in increasing our understanding of this ground-breaking technology.

In September 2003 it hosted the 1st International EMCCD Symposium in Limavady, Northern Ireland, a dedicated conference which looked at the current usage and future development of EMCCDs. This was followed in April 2005 by the 2nd International EMCCD Symposium, held in Connecticut, USA. Please go to www.emccd.com for further details.

4.2 - EMCCD SENSOR

The EMCCD sensor is the core enabling technology of the system. Everything else in the camera has been designed to extract the absolute best operational performance from this sensor. All EMCCD sensors in the iXon Ultra range have a frame transfer architecture. The frame-transfer EMCCD uses a two-part sensor in which one-half of the array is used as a storage region and is protected from light by a light-tight mask. Incoming photons are allowed to fall on the uncovered portion of the array and the accumulated charge is then rapidly shifted into the masked storage region for transfer to the serial output register. While the signal is being integrated on the light-sensitive portion of the sensor, the stored charge is read out. Frame transfer devices have typically faster frame rates than full frame devices, and have the advantage of a high duty cycle i.e. the sensor is always collecting light.

A potential disadvantage of this architecture is the charge smearing during the transfer from the light-sensitive to the masked regions of the CCD (although they are significantly better than full frame devices). The smearing is more prevalent when exposure times are closer to the time taken to shift the charge under the mask (in the order of milliseconds).

The Andor iXon Ultra is the best camera on the market for minimizing such smear, as the vertical clock speeds can be tuned via the software to deliver the fastest parallel shifts in the industry, which has the further advantage of faster overall frame rates (especially when using sub-array and/or pixel binning readout options).

Essentially, the EMCCD sensor is capable of detecting single photon events without an image intensifier, achievable by way of a unique electron multiplying structure built into the chip. Traditional CCD cameras offered high sensitivity, with readout noises in single figure $< 10e^-$ but at the expense of slow readout. Hence they were often referred to as 'slow scan' cameras. The fundamental constraint came from the CCD charge amplifier. To have high speed operation the bandwidth of the charge amplifier needs to be as wide as possible. However, it is a fundamental principle that the noise scales with the bandwidth of the amplifier, hence higher speed amplifiers have higher noise.

Slow scan CCD's have relatively low bandwidth and hence can only be read out at modest speeds, typically less than 1MHz. EMCCD cameras avoid this constraint by amplifying the charge signal before the charge amplifier and hence maintain unprecedented sensitivity at high speeds. By amplifying the signal the readout noise is effectively by-passed and, as such, EMCCD readout noise is no longer a limit on sensitivity (and can often be considered negligible).

Please see **pages 87- 88** for further details on EMCCD technology and sensor architecture.

4.3 - VACUUM HOUSING

Unless protected, cooled CCD sensors will condense moisture, hydrocarbons and other gas contaminants that will attack the CCD surface. If that happens, CCD performance will decline proportionally and will eventually fail. Fortunately, the integrity of the sensor can be preserved by housing it in a protective enclosure. However, it is important to understand that all such environments are not the same and the underlying technology used can seriously impact camera life (and performance).

A permanent hermetic vacuum head is an essential component of high-end imaging and spectroscopy EMCCD cameras. A permanent vacuum requires not only a hermetic seal, but also low outgassing. These criteria are what Andor's UltraVac™ vacuum process uniquely ensures. It is the low **outgassing (see page 93)** that is the real challenge and, in reality, what sets the real limit on long-term performance. Andor has developed and utilized the UltraVac™ process over more than 10 years, so it is proven with 1,000s of systems in the field and a measured **Mean-Time-Between-Failure (MTBF)** of 100 years; that means it will take 100 years for half of them to fail.

Furthermore, Andor's rigorous, proprietary vacuum process is carried out in a Class 1,000 clean room; this means less than 1,000 particles of less than 0.5 micron dimension per cubic meter. The air is fully replenished every minute. We welcome visitors to inspect our state-of-the-art facility.

Benefits of UltraVac™

- Sustained vacuum performance over many years operation – proprietary process to minimize outgassing
- Benefit from a thoroughly proven solution - UltraVac™. 10 years of shipping vacuum systems to the field and a negligible failure rate (an MTBF of 100 years)
- Performance improves because the temperature of the chip can be reduced significantly. Better cooling (down to -100°C with an enhanced thermoelectric Peltier design) translates into substantially lower darkcurrent and fewer blemishes
- Such darkcurrent performance is particularly critical to EMCCD technology, where even a single thermal electron is detected as a spurious noise spike
- Elimination of condensation and outgassing means that the system can also use only a single entrance window, with antireflection coating – you can believe the QE curve
- The permanent hermetic vacuum ensures that peak quantum efficiency and cooling will not degrade, even after years of operation

4.3.1 - Thermoelectric cooler

The iXon Ultra range makes use of a four-stage Peltier cooling assembly, which utilizes the thermoelectric effect to rapidly cool the sensor down to the stable operating temperature. TE coolers have a cold end (in contact with the sensor) and a hot end. Heat must be efficiently dissipated from the TE cooler for effective cooling of the sensor.

The iXon Ultra is expertly designed to yield maximum heat dissipation, via either forced air cooling (in-built fan) or water cooling which, in combination with Andor's UltraVac™ vacuum process, results in market-leading cooling performance. A recirculator or a chiller can be purchased from Andor Technology to provide convenient and effective heat dissipation through water cooling.

The iXon Ultra camera also contains temperature control components, which regulate the cooling of the camera and ensure that a stable temperature is maintained between and throughout measurements.

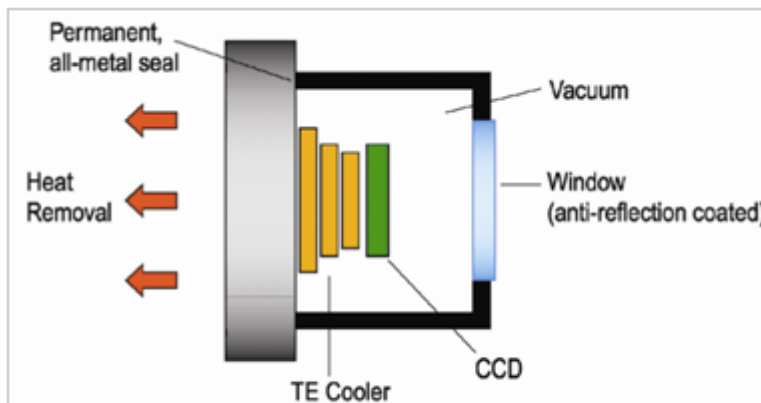

4.4 – USB 2.0 INTERFACE

USB 2.0 is a convenient interface standard for use with a Scientific camera, as it is designed to be “plug and play” and is available on all modern PCs, including Laptops and tablet PCs. Most modern desktop PCs will be able to support at least two iXon Ultras running at full Frame rate.

The underlying system software of the PC is responsible for automatically assigning resources and usually performs this properly – some conflicts can arise when resources are not released properly by third party USB drivers. Please contact Andor on how to resolve this conflict if problems are encountered.

Most PCs are fitted with two EHCI (Enhanced Host Controller Interfaces) and are therefore able to support two devices running USB 2.0 at “high speed”. USB 3.0 PCI-e interface cards can be used if more than two high speed USB 2.0 interfaces are required simultaneously (USB 2.0 interface cards generally use a PCI interface standard and do not offer the adequate bandwidth).

On some desktop PCs, the USB connectors on the front panel are implemented badly and will fail to connect to any USB 2.0 high speed device. If this occurs, use a rear panel USB connector as these are mounted directly on the motherboard.

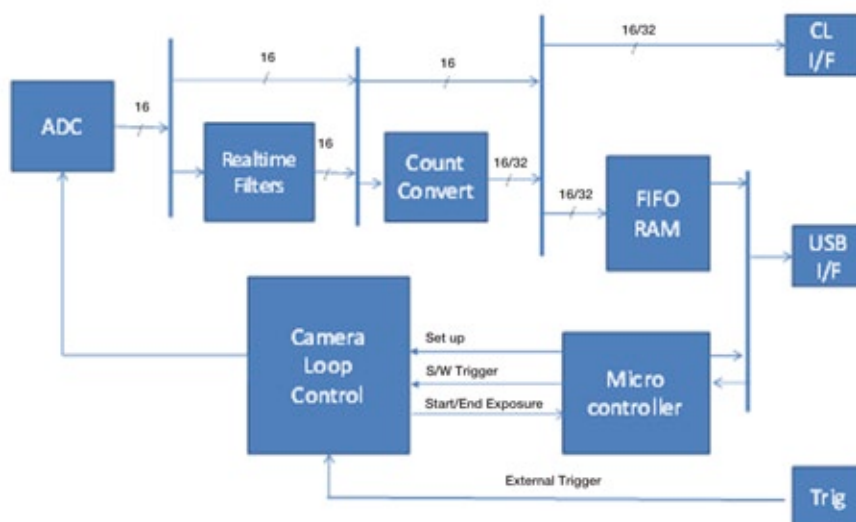

Figure 40: Camera Architecture

If the PC is busy when transfers are ongoing – a buffer memory is available within the camera – this is usually at 2-3% fill. The camera will issue a warning if the processing load on the PC is excessive and it is starting to impact on the memory fill of the camera.

The iXon Ultra automatically switches from 16 bit to 32 bit transfer mode – when running with real time count convert active for example. This happens seamlessly under software control, and is needed because, in count convert mode, the number of electrons/photons detected can be $> 2^{16}$.

4.5 - OUTGASSING

Outgassing is the release of a gas trapped in material. It is a problem encountered in high-vacuum applications. Materials not normally considered absorbent can release enough molecules to contaminate the vacuum and cause damage to optical sensors, window coatings, etc.

Even metals and glasses can release gases from cracks or impurities but sealants, lubricants and adhesives are the most common cause. Left unchecked, cooling performance would steadily degrade and therefore lead to increased dark current. Furthermore, resulting electrochemical reactions would eventually destroy the sensor.

4.6 - EXTERNAL I/O

To enable additional functionality, the 4 x SMB connectors and Fischer connector from the iXon3 have been replaced with a 26 way high density D-type connector.

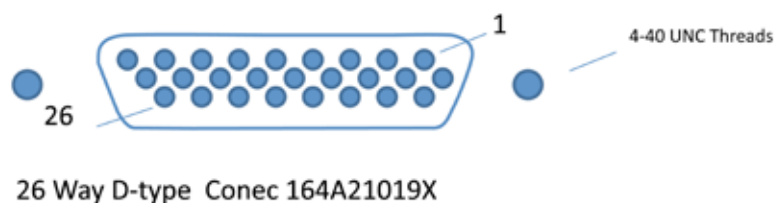

Figure 41: iXon Ultra IO connector

Pinout for D-Type connector

1	External Trigger	10	I/O data bit 0	19	5 V Out
2	Trigger Invert	11	I/O data bit 1	20	GND
3	GND	12	I/O data bit 2	21	I2C Data
4	Output DAC 1	13	I/O data bit 3	22	I2C Clock
5	Output DAC 2	14	I/O data bit 4	23	Shutter Control Output
6	GND	15	I/O data bit 5	24	Arm Output
7	Frame Output	16	I/O data bit 6	25	GND
8	Fire Output	17	I/O data bit 7	26	GND
9	Reserved Output	18	GND		

NOTE: Pin 9 is now a reserved pin as interline shift is meaningless on the iXon.

4.7 - SIGNAL DIAGRAMS

iXon Ultra Input & Output Timing Hardware

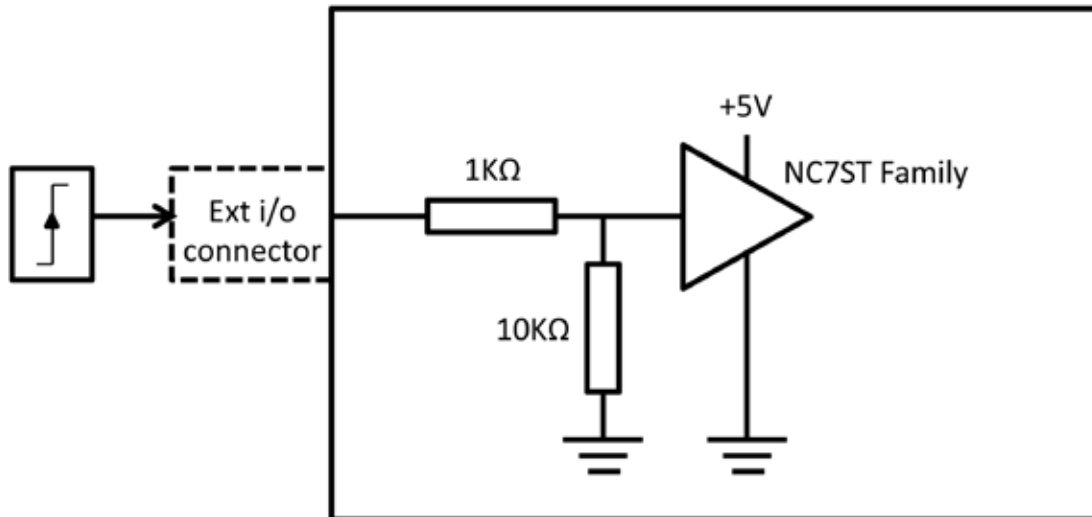

Figure 41: External Trigger

External Trigger Input (at connector)

- V_{IH} (High level input voltage, minimum) = 2.2V
- V_{IL} (Low level input voltage, maximum) = 0.88V
- Change to falling edge trigger by connecting “Trigger Invert Input” pin to Ground with $\leq 500\Omega$

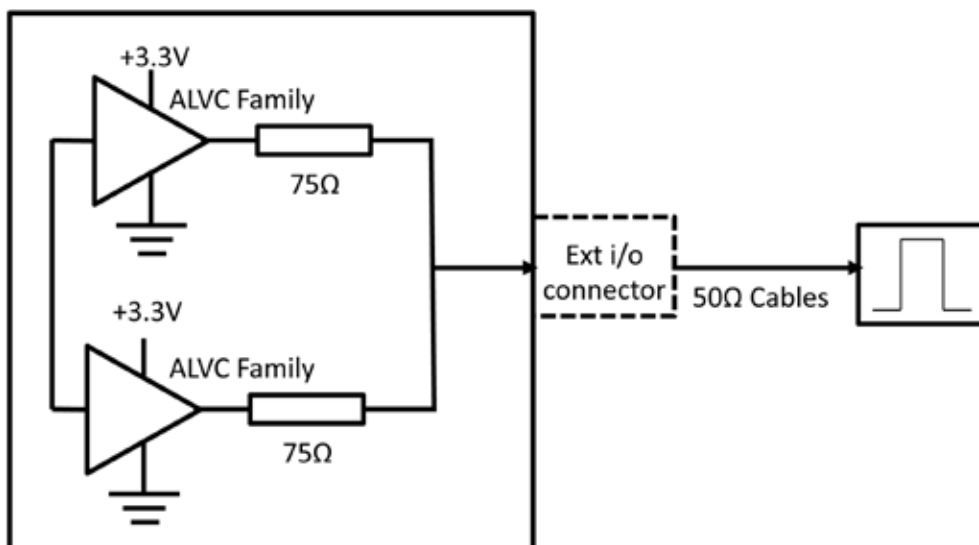

Figure 42: Fire & Shutter

Fire, Shutter, Arm & Frame Output (at connector)

- Use 50Ω cable + high impedance input ($>1k\Omega$)
- Drive both TTL & CMOS unterminated input

SECTION 5: TROUBLESHOOTING

5.1 - UNIT DOES NOT SWITCH ON

- Check power cord is plugged in and connected correctly to mains supply
- If applicable, replace fuse in the supplied mains cable as detailed in **page 21**
- If the unit still does not switch on after the checks above have been carried out, contact Andor Technical Support

5.2 - SUPPORT DEVICE NOT RECOGNISED WHEN PLUGGED INTO PC

- Choose another USB port
- If this is unsuccessful review “Use of Multiple high speed USB 2.0 I/O on one camera” in the trouble shooting guide.

5.3 - TEMPERATURE TRIP ALARM SOUNDS (CONTINUOUS TONE)

To protect the camera from overheating, a thermal switch has been attached to the heat sink. If the temperature of the heat sink rises above the predefined limit, the power supply to the cooler will cut off and a buzzer will sound. Should the buzzer sound ensure the following:

Air Cooling

- That the air vents on the sides of the detector head have not become accidentally blocked
- There is sufficient clearance (100 mm) around the camera
- The ambient air temperature is not above 30°C
- The fan has not been deactivated (or the speed set too low) in software
- Check that no foreign bodies are obstructing the fan's rotation

Water Cooling

- That there is sufficient water flow passing through the camera head
- **NOTE: When using water cooling, always use water that is above the dew point of the ambient environment otherwise condensation may occur.**

The cut-out will not reset until the camera has been powered off and the temperature of the metalwork reaches a predefined limit. It is not recommended that you operate in conditions that would cause repeated cut-outs, as the thermal switch has a limited number of operations.

5.4 - CAMERA HIGH FIFO FILL ALARM

On some systems, it has been observed that a camera will stop acquiring after approximately 1 - 10 seconds. When this occurs it has always been caused by insufficient USB bandwidth. The camera includes a buffer (FIFO) to overcome any short term bandwidth reductions, however, a sustained insufficient bandwidth will always cause the buffer to overflow – regardless of what size of buffer is used. The PC should be able to cope with a sustained USB data transfer of equal to or greater than 40 Megabytes/second. Modern machines should all be able to cope with this.

Two causes of USB 2.0 Cameras stopping acquisition have been found thus far:

1) **Power saving settings in the PC BIOS.** All PC systems are now required to be shipped in power saving mode (under EUP legislation). In the Dell T5500 models (and likely all new systems) there is a setting in the BIOS called “C States Control”. Ensure this is disabled, as this saves power by sacrificing USB bandwidth. Other PC manufacturers may have similar settings.

2) **Sharing USB bandwidth with other devices.** An example of this is using USB to RS-232 adapters. These significantly reduce the USB bandwidth available, to the point where the camera can not continuously transmit images. This occurs even if the software that uses these USB to RS-232 devices has not been started.

This problem can only be overcome if the PC being used has dual USB Enhanced Host Controllers. Dell 760 machines have ICH10 family southbridges, which have two “Enhanced Host Controllers” (EHC) . Each one of these is able to receive the maximum USB rate from a Clara/iXon Ultra (assuming there is sufficient RAM, CPU etc to process the data).

If the machine has only one EHC it may not be possible to operate a Clara/iXon Ultra and any other devices that require significant USB bandwidth.

To ensure the Camera has full USB bandwidth it is best to ensure it does not share its EHC with any other High Bandwidth USB devices i.e. do not connect the USB to RS-232 adaptors into the same EHC. These two EHCs can be shared between the front and the back USB ports of the PC and so it may be advantageous to map which physical USB port is associated with which EHC.

5.5 - USE OF MULTIPLE HIGH SPEED USB 2.0 I/O ON ONE CAMERA

On PCs with two or more EHCs it may be beneficial to map each physical USB connector to it's EHC. Below shows how to do this on a Dell T5500 PC using a (modern) USB memory stick and the application “**UVCView.x86.exe**” from Microsoft.

USB devices can be High Bandwidth (Fastest), Full Bandwidth or Low bandwidth (e.g. mouse, keyboard). A modern USB stick will be High Bandwidth.

Run UVCView.exe to monitor the USBs ports usage.

To map each port, use a High Bandwidth device such as a modern USB memory stick. High bandwidth devices will only appear in an EHC section, as shown below, where one can see the USB mass storage device under “Enhanced Host Controller - 3A6A”. There is a second EHC called 3A6C. Test each physical port by placing the USB memory stick into it and record which EHC it is connected to. After changing the port the window should update automatically after several seconds – if it does not, press F5 to refresh it.

Example USB Map Hub and layout

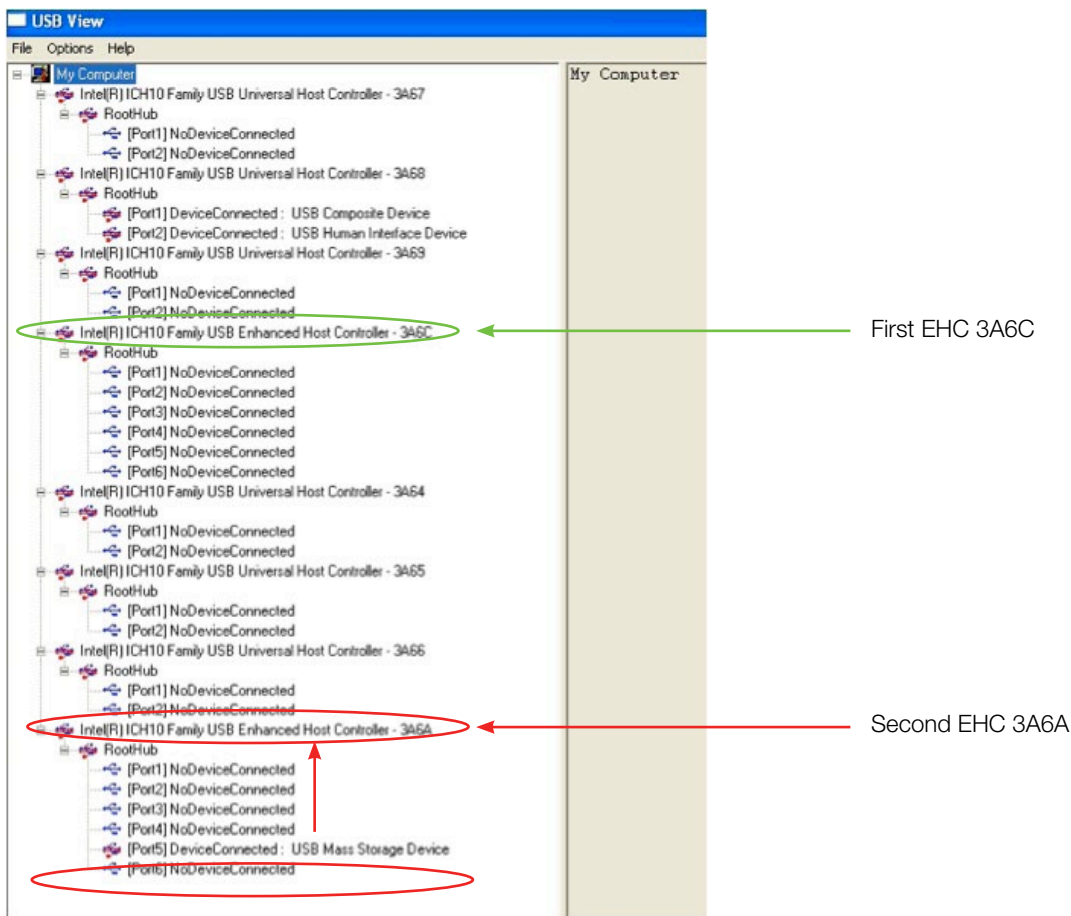

Front:



Back:



A.1 - GLOSSARY

If this is the first time you have used Andor's EMCCD, the glossary that follows will help you to familiarize yourself with its design philosophy and some of its key terminology.

A.1.1 - Readout sequence of an EMCCD

In the course of readout, charge is moved vertically into the shift register then horizontally from the shift register into the output node of the amplifier. The simple readout sequence illustrated below (which corresponds to the default setting of the Full Resolution Image binning pattern) allows data to be recorded for each individual element on the EMCCD-chip. Other binning patterns are achieved by summing charge in the shift register and/or the output node prior to readout. For further information on binning, please refer to [page 55](#)).

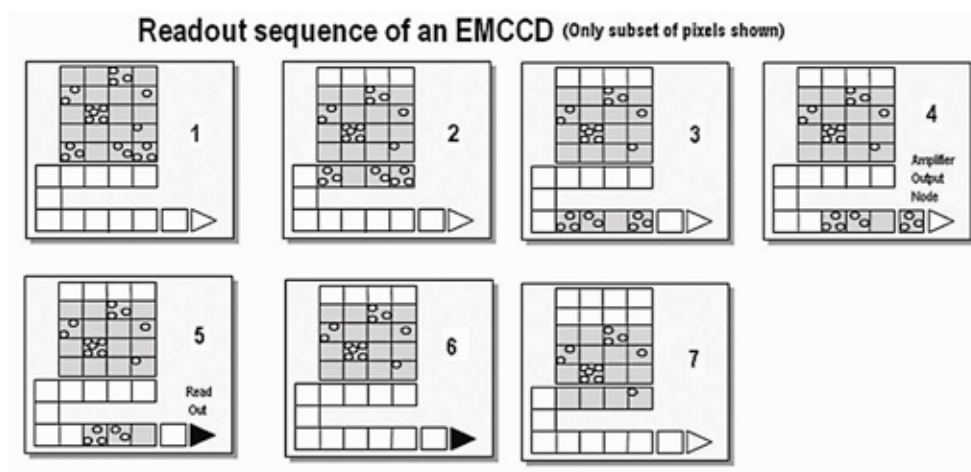

Figure 43: Readout sequence of an EMCCD

1. Exposure to light causes a pattern of charge (an electronic image) to build up on the frame (or Image Area) of the EMCCD-chip
2. Charge in the frame is shifted vertically by one row, so that the bottom row of charge moves into the shift register.
3. Charge in the shift register is moved horizontally by one pixel, so that charge on the endmost pixel of the shift register is moved into the Gain register.
4. Charge is shifted into the output node of the amplifier.
5. The charge in the output node of the amplifier is passed to the analog-to-digital converter and is read out.
6. Steps 3 and 4 are repeated until the shift register is emptied of charge.
7. The frame is shifted vertically again, so that the next row of charge moves down into the shift register.

The process is repeated from Step 3 until the whole frame is read out.

A.1.2 - Accumulation

Accumulation is the process by which data that have been acquired from a number of similar scans are added together in computer memory. This results in improved signal to noise ratio.

A.1.3 - Acquisition

An Acquisition is taken to be the complete data capture process.

A.1.4 - A/D Conversion

Charge from the CCD is initially read as an analogue signal, ranging from zero to the saturation value. A/D conversion changes the analogue signal to a binary (digital) number, which can then be manipulated by the computer.

A.1.5 - Background

Background is a data acquisition made in darkness. It is made up of fixed pattern noise, and any signal due to dark current.

A.1.6 - Binning

Binning is a process that allows charge from two or more pixels to be combined on the EMCCD-chip prior to readout.

A.1.7 - Counts

Counts refer to the digitization by the A/D conversion and are the basic unit in which data are displayed and processed. Depending on the particular version of the detection device, one count may, for example, be equated with a charge of 10 photoelectrons on a pixel of the CCD.

A.1.8 - Dark Signal

Dark signal, a charge usually expressed as a number of electrons, is produced by the flow of dark current during the exposure time. All CCDs produce a dark current, an actual current that is measurable in (typically tenths of) milliamps per pixel. The dark signal adds to your measured signal level, and increases the amount of noise in the measured signal. Since the dark signal varies with temperature, it can cause background values to increase over time. It also sets a limit on the useful exposure time. Reducing the temperature of the CCD reduces dark signal (typically, for every 7°C that temperature falls, dark signal halves). CCD readout noise is low, and in order not to compromise this by shot noise from the dark signal, it is important to reduce the dark signal by cooling the detector. If you are using an exposure time of less than a few seconds, cooling the detector below 0°C will generally remove most of the shot noise caused by dark signal.

A.1.9 - Detection Limit

The Detection Limit is a measure of the smallest signal that can be detected in a single readout. The smallest signal is defined as the signal whose level is equal to the noise accompanying that signal, i.e. a Signal to Noise ratio (S/N) of unity. Sources of noise are as shown hereunder:

- Shot noise of the signal itself
- Shot noise of any dark signal
- Readout noise

If the signal is small, we can ignore its shot noise. Furthermore, if a suitably low operating temperature and short exposure time can be achieved, the lowest detection limit will equal the readout noise.

A.1.10 - Exposure Time

The Exposure Time is the period during which the CCD collects light prior to readout.

A.1.11 - Frame Transfer

Frame transfer is a special acquisition mode that is only available if your system contains a Frame Transfer CCD (FT CCD). An FT CCD differs from a standard CCD in 2 ways. Firstly, it contains 2 areas of approximately equal size as shown hereunder:

1. The first area is the **Image Area**, which is located at the top and farthest from the readout register. This is the light sensitive area of the CCD.
2. The second section is the **Storage Area**, and is located between the Image Area and the readout register. This section is covered by an opaque mask, usually a metal film, and hence is not sensitive to light.

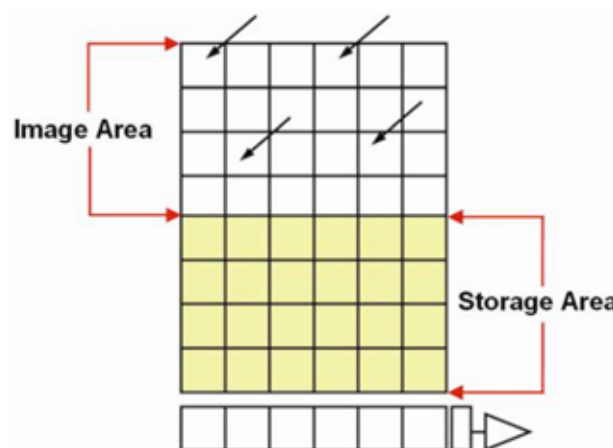

Figure 44: Frame transfer

The second way in which a FT CCD differs from a standard CCD is that the Image and Storage areas can be shifted independently of each other. These differences allow a FT CCD to be operated in a unique mode where one image can be read out while the next image is being acquired. It also allows a FT CCD to be used in imaging mode without a shutter. Note: This is only applicable when the camera is running in Accumulate or Kinetic mode.

The Pixel Noise is the variation in the pixel's charge level when exposed to a constant signal flux over a significantly valid period of read levels. The pixel noise is normally expressed as the value of the Root Mean Square (rms) of these variations.

Note: As a rule of thumb, the rms value is x 4 to x 6 smaller than the peak to peak variations in the level values read from the pixel.

Pixel Noise has three main constituents:

- Readout noise
- Shot noise from the dark signal
- Shot noise from the light signal itself

Shot noise cannot be removed due to the laws of Physics. Most simply defined, shot noise is the squareroot of the signal (or dark signal) measured in electrons.

A.1.12.1.1 - Readout Noise

Readout noise is due to the amplifier and electronics. It is independent of dark signal and signal levels, and is only very slightly dependent on temperature. It is present on every readout, as a result of which it sets a limit on the best achievable noise performance.

A.1.12.1.2 - Shot Noise

Shot noise is a statistical variation in signal level which follows a Poisson distribution. The shot noise relates to the generating signal by the following relationship:-

Shot noise \approx sqrt Signal

If the source of signal from which the shot noise is generated falls to zero, the shot noise also falls to zero.

A.1.12.1.2.A - Shot Noise from the Signal

Shot noise is caused by dependence on the signal generated by the light falling onto the sensor.

A.1.12.1.2.B - Shot Noise from the Dark Signal

Shot noise from the dark signal is related to the electrons generated within the sensor, Dark Current etc. Therefore it is dependent on the exposure time and it is very dependent on the temperature.

A.1.12.1.3 - Calculation of Total Pixel Noise

The total pixel noise is not simply the sum of the three main noise components (readout noise, shot noise from the dark signal and shot noise from the signal). Rather, the rms gives a reasonable approximation - thus:

total = sqrt (readnoise² + darkshot² + sigshot²)

where:

- total is the pixel noise
- readnoise is the readout noise
- darkshot is the shot noise of the dark signal
- sigshot is the shot noise of the signal

A.1.12.2 - Fixed Pattern Noise

Fixed Pattern Noise (FPN) consists of the differences in count values read out from individual pixels, even if no light is falling on the detector. These differences remain constant from read to read. The differences are due in part to a variation in the dark signal produced by each pixel, and in part to small irregularities that arise during the fabrication of the CCD and in part to settling time of the electronics. Since fixed pattern noise is partly due to dark signal, it will change if the temperature changes but, because it is fixed, it can be completely removed from a measurement by background subtraction.

A.1.13 - Quantum Efficiency/Spectral Response

The glossary refers to signals as a number of electrons. Strictly speaking, these are “photoelectrons” created when a photon is absorbed. When a UV or visible photon is absorbed by the detector it can, at best, produce only one photoelectron. Photons of different wavelengths have different probabilities of producing a photoelectron, and this probability is usually expressed as **Quantum Efficiency (QE)** or **Spectral Response**.

QE is a percentage measure of the probability of a single photon producing a photoelectron, while spectral response is the number of electrons that will be produced per unit photon energy. Many factors contribute to the QE of a CCD, but the most significant factor is the absorption coefficient of the silicon that serves as the bulk material of the device.

A.1.14 - Readout

Readout is the process by which data are taken from the pixels of the CCD and stored in computer memory. The pixels, which are arranged in a single row, are read out individually in sequence. Readout involves amplifying the charge on each pixel into a voltage, performing an analog to digital conversion and then storing the data in computer memory. The time taken to perform this operation is known as the “read time”.

A.1.15 - Saturation

Saturation is the largest signal the CCD can measure. A signal is measured in terms of the amount of charge that has built up in the individual pixels on the CCD-chip. A number of factors determine the maximum amount of charge that the CCD can handle.

A.1.16 - Scans (Keep Clean and Acquired)

The CCD is continually being “scanned” to prevent its becoming saturated with dark current (see **Dark Signal on page 99**).

- If the scan is being used simply to “clean” the CCD (i.e. it is a keep-clean scan), the charge from the CCD is discarded
- In an acquired scan, however, the charge undergoes analog to digital conversion and is acquired into computer memory so that it can be used for subsequent processing and display: it is “read out” (see **Readout** above)

Unless the context specifically indicates otherwise, “scan”, in this User Guide, generally refers to an acquired scan.

A.1.17 - Shift Register

The Shift Register usually consists of a single row of elements (or pixels) running parallel to, and below, the bottom row of light-gathering pixels (the image area) on the CCD-chip. The shift register is protected from light by an aluminium mask. The elements in the shift register have a greater capacity to store charge (i.e. a greater “well depth”) than the other pixels on the CCD-chip.

A.1.17 - Shot Noise

Shot Noise is due to the basic laws of physics and cannot be removed. Any signal, whether it is a dark signal or a light signal, will have shot noise associated with it. In its most simple form it can be defined thus:

If the signal or dark signal = N electrons, then the shot noise is the square root of N .

You can do nothing about the shot noise of your signal, but by choosing minimum exposures and operating the CCD at suitably low temperatures, the dark signal, and consequently the noise from the dark signal, can be reduced.

A.1.18 - Signal To Noise Ratio

The **Signal to Noise Ratio** (commonly abbreviated as **S/N** or **SNR**) is the ratio between a given signal and the noise associated with that signal. Noise has a fixed component and a variable component (shot noise), which is the square root of the signal. Thus, the S/N usually increases (improves) as the signal increases.

The maximum S/N is the ratio between the maximum signal (i.e. the saturation level) and the noise associated with that signal. At near saturation levels the dominant source of noise is the shot noise of the signal.

B - MECHANICAL DIMENSIONS

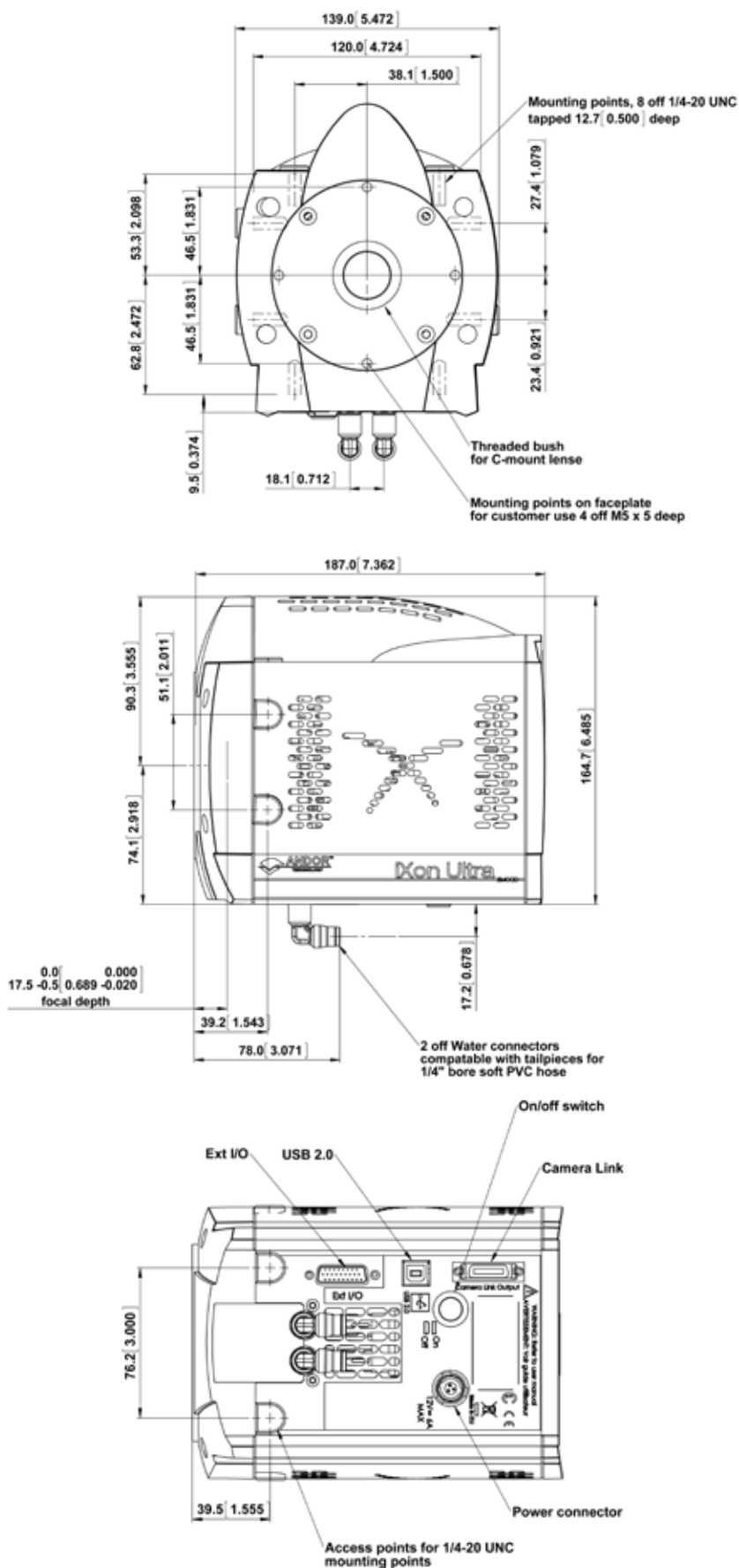

C - DECLARATION OF CONFORMITY

**Belfast Office
Corporate Headquarters**

7 Millennium Way
Springvale Business Park
Belfast BT12 7AL
Northern Ireland

Tel: +44 (28) 9023 7126
Fax: +44 (28) 9031 0792
Web: www.andor.com



discover new ways of seeing™



Description of Equipment

The following product is manufactured in the United Kingdom by Andor Technology plc:

iXon Ultra Scientific Digital Camera (DU-897U)

EU Declaration of Conformity (EMC)

Andor Technology plc hereby declares under its sole responsibility that the aforementioned product meets the requirements of **EU EMC Directive 2004/108/EC** by means of conformity to the following harmonised standards:

- EN 61326-1:2006 Electrical equipment for measurement, control and laboratory use - EMC requirements - Part 1: General requirements [Class A Group 1 Basic Immunity]
- EN 55011:2007 Industrial, scientific and medical (ISM) radio-frequency equipment - Electromagnetic disturbance characteristics - Limits and methods of measurement [Class A]
- EN 61000-4-2:2009 Electromagnetic compatibility (EMC) - Testing and measurement techniques - Electrostatic discharge immunity test [Criterion A]
- EN 61000-4-3:2006 Electromagnetic compatibility (EMC) - Testing and measurement techniques - Radiated, radio-frequency, electromagnetic field immunity test [Criterion A]
- EN 61000-4-4:2004 Electromagnetic compatibility (EMC) - Testing and measurement techniques - Electrical fast transient/burst immunity test [Criterion B]
- EN 61000-4-5:2006 Electromagnetic compatibility (EMC) - Testing and measurement techniques - Surge immunity test [Criterion A]
- EN 61000-4-6:2009 Electromagnetic compatibility (EMC) - Testing and measurement techniques - Immunity to conducted disturbances, induced by radio-frequency fields [Criterion A]
- EN 61000-4-11:2004 Electromagnetic compatibility (EMC) - Testing and measurement techniques - Voltage dips, short interruptions and voltage variations immunity tests [Criterion A]



Offices in:

North America
Japan
China

Co. Reg. No. NI 22466
VAT No. GB 517 1829 44

EU Declaration of Conformity (LVD)

Andor Technology plc hereby declares under its sole responsibility that the aforementioned product meets the requirements of **EU Low Voltage Directive 2006/95/EC** by means of conformity to the following harmonised standards:

- EN 61010-1:2001 Safety requirements for electrical equipment for measurement, control and laboratory use - Part 1: General requirements (*identical to IEC 61010-1*)

Additional EMC Standards

This product also complies with the following:

- FCC Part 15 Subparts A and B Code of Federal Regulations
Title 47: Telecommunications - Part 15: Radiofrequency Devices [Class B]
- EN 61000-3-2:2006 Electromagnetic compatibility (EMC) - Limits - Limits for harmonic current emissions (equipment input current ≤ 16 A per phase)
- DD ENV 50204:1996 Radiated electromagnetic field from digital radio telephones - Immunity test [Criterion A]

Additional Safety Standards

This product also complies with the following:

- All national deviations listed under the IEC CB Scheme for IEC 61010-1 for those countries that require them (currently Australia, Canada, Japan, Korea, Switzerland and USA) including the following, amongst others:
 - UL 61010-1 Safety requirements for electrical equipment for measurement, control and laboratory use - Part 1: General requirements (2nd Edition 2004)
 - CAN/ CSA-C22.2 No. 61010-1-04 Safety requirements for electrical equipment for measurement, control and laboratory use - Part 1: General requirements (2nd Edition)

CE Mark

CE Mark first applied to this product in the year 2012.



Gary Wilmot
Director of Engineering
26th March 2012

D - HARDWARE AND SOFTWARE WARRANTY SERVICE

D.1 - SERVICE DESCRIPTION

- D.1.1 The Andor Repair service provides a repair and return service for defective products supplied by Andor under a supply contract. Using this service, the original ,defective part sent in by the Customer will be, where possible, returned after repair or will be replaced. Any warranty obligation contained in an Andor supply contract will be carried out in accordance with this Repair Service.
- D.1.2 In order to be eligible for warranty repair or replacement, the equipment must be suffering a defect which meets the criteria set out in the supply contract and must be within its specified warranty period. Services such as upgrades to Hardware and Software are excluded from the scope of this service description and should be ordered separately.

D.2 - Access to Service

- D.2.1 A Customer who has purchased their product via a reseller or third party and who believes they have a warranty defect should in the first instance contact a representative of their seller's product support team. Customers who have bought products directly from Andor can access the Service Desk at www.andor.com/contact_us/support_request
- D.2.2 The Customer should indicate that they are pursuing a warranty claim and specify the equipment type and the contract under which it was supplied. The Service Desk representative will then work with the Customer to establish the nature of the defect and to determine whether the reported defect is one which meets the criteria under the supply contract for warranty remediation. This process will comprise question and answer between Service Desk and Customer and the Service Desk operative may, at their sole discretion, ask the Customer to perform some basic diagnostic actions in relation to the problem item.

D.3 - Hardware Remediation

- D.3.1 If the issue cannot be resolved remotely and a fault has been diagnosed, a Return Materials Authorization (“RMA”) number will be issued. This RMA number will be valid for 30 days from the date of issue. An RMA number must be obtained from Andor prior to the return of any material. The RMA number must appear clearly on the outside of the shipping container and on return paperwork included inside the package.
- D.3.2 Following allocation of a RMA number by Andor, the Customer shall ship the PART to Andor at customer expense. The customer is responsible for return shipping and insurance costs. Any products returned without an RMA number may be refused and returned to the customer at their expense. Andor shall provide a single point of return for all products.
- D.3.3 On receipt of the part at the Andor repair facility, Andor shall carry out the necessary fault diagnosis and repair and return the part to the Customer.
- D.3.4 The method of shipment and choice of courier for the return will be at Andor’s discretion. Delivery Duties Unpaid (DDU) Incoterms 2000: Andor does not guarantee the arrival time of the part.
- D.3.5 Customer must adhere to Andor packing instructions (including anti-static precautions) when shipping the defective unit, as any damage incurred during shipment to Andor will not be covered under warranty. The packing instructions can be obtained from Andor as part of the request procedure.
- D.3.6 If the part is not economically repairable then a replacement part (new or refurbished) will be supplied at Andor’s discretion and expense.
- D.3.7 In case of replacement, the replacement unit becomes the property of the Customer on an exchange basis.
- D.3.8 In case of misuse, the Customer will be contacted to decide the course of action. These actions may include:
- Scrapping the part
 - Return of the defective unrepaired part to the Customer
 - Replacement with a new or refurbished part. Andor will invoice the customer the full merchandise contracted customer price of the unit
- D.3.9 Unless elsewhere agreed between the Customer and Andor, this service does not include root cause analysis, the provision of fault reports or lead-time and performance metrics.

D.4 - Software Remediation

- D.4.1 During Warranty Customers have access to the Service Desk at www.andor.com/contact_us/support_request to report product defects. A Customer who has purchased their product via a reseller or third party and who believes they have a software warranty defect should in the first instance contact a representative of their seller's product support team.
- D.4.2 Where as a result of the process described in 1.3.2 above it is determined that the defect relates to software, a trouble ticket will be logged in respect of the software issues observed.
- D.4.3 Under the warranty provisions of the supply contract we will not provide the customer with a guaranteed SLA (service level agreement) for their problem.

E - THE WASTE ELECTRONIC AND ELECTRICAL EQUIPMENT REGULATIONS 2006 (WEEE)

Where appropriate, Andor has labelled its electronic products with the WEEE label (crossed out wheelie bin) to alert our customers that products bearing this label should not be disposed of in a landfill or with municipal waste. If you have purchased Andor-branded electrical or electronic products in the EU after August 13, 2005, and are intending to discard these products at the end of their useful life, Andor is happy to assist.

The cost for the collection, treatment, recycling, recovery and sound environmental disposal of these goods at the end of its useful life has not been included in the price. If you require help/assistance regarding the disposal of this equipment please refer to our website, or contact our sales team at which point instructions and a quotation can be provided.

A copy of the Company's WEEE Policy can be viewed at the Company website www.andor.com

TERMS AND CONDITIONS OF SALE

The terms and conditions of sale, including warranty conditions, will have been made available during the ordering process. The current version may be viewed at:

http://www.andor.com/contact_us/support_request/warranty/standard_warranty.pdf

WASTE ELECTRICAL AND ELECTRONIC EQUIPMENT (WEEE)



The company's statement on the disposal of WEEE can be found in the Terms and Conditions.