

USERS GUIDE



iDus InGaAs



www.andor.com

© Andor Technology plc 2010

	<u>PAGE</u>
SECTION 1 - ABOUT THE iDus InGaAs	12
1.1 - INTRODUCTION	12
1.2 - WORKING WITH THE USERS GUIDE	12
1.3 - HELP	12
1.4 - DISCLAIMER	13
1.5 - TRADEMARKS & PATENT INFORMATION	13
1.6 - TECHNICAL SUPPORT	14
Europe	14
USA	14
Asia-Pacific	14
China	14
1.7 - COMPONENTS	15
1.7.1 - Optional Extras	15
1.7.2 - Camera	15
1.7.3 - Power Supply Unit	16
1.7.4 - Software	17
1.7.5 - Manuals	17
1.7.6 - Spectrograph (optional)	17
1.7.7 - Mounting Flanges (optional)	17
1.8 - SAFETY PRECAUTIONS & SAFE CAMERA OPERATION	18
1.8.1 - Care of the camera	18
1.8.2 - Environmental conditions	18
1.8.3 - Additional statement regarding equipment operation	18
1.8.4 - Working with electronics	19
1.8.5 - Head overheating	19
1.8.6 - Cooling	20
1.8.6.1 - Air cooling	20
1.8.6.2 - Water cooling	21
1.8.6.3 - Condensation	21
1.8.6.4 - Dew Point graph	22
1.8.6.5 - Fan settings	22
1.8.6.7 - Stray light	23

SECTION 2 - INSTALLATION	24
2.1 - COMPUTER REQUIREMENTS	24
2.2 - INSTALLING THE SOFTWARE & USB DRIVER	25
2.3 - CONNECTIONS	28
2.3.1 - New Hardware Wizard	29

SECTION 3 - USING THE IDUS INGAAS	30
3.1 - STARTING THE APPLICATION	30
3.2 - MAIN WINDOW	31
3.3 - HOT KEYS	33

SECTION 4 - PRE-ACQUISITION	34
4.1 - SETTING TEMPERATURE	34
4.2 - SETUP ACQUISITION	35
4.3 - AUTO-SAVE	37
4.3.1 - Virtual Memory	38
4.4 - SPOOLING	39

SECTION 5 - ACQUIRING DATA	40
5.1 - INITIAL ACQUISITION	40
5.2 – RAW DATA	41
5.3- DATA TYPE SELECTION	41
5.2.1 - Definitions of data types	41
5.3 - DATA FLIPPING	45
5.4 - ACQUISITION TYPES	46
5.4.1 - Autoscale Acquisition	46
5.4.2 - Take Background	47
5.4.3 - Take Reference	47
5.4.4 - Acquisition Errors	47
5.5 - ACQUISITION MODES & TIMINGS	48
5.5.1 - Single Scan	48
5.5.2 - Real Time	48
5.5.3 - Accumulate	49
5.5.4 - Kinetic Series & Accumulated Kinetic Series	50
5.6 - TRIGGERING MODES	51
5.6.1 - Internal	51
5.6.2 - External	51
5.6.3 - External Start	51
5.7 - TRIGGERING TYPE SELECTION	52
5.8 - TIMING PARAMETERS	53
5.9 - SHUTTER	54
5.9.1 - Time to open or close	56
5.9.2 - Exposure Time	57
5.9.3 - Accumulate Cycle Time & No. of Accumulations	57
5.9.4 - Kinetic Series Length & Kinetic Cycle time	57
5.10 - COSMIC RAYS	58
5.11 - GAIN & NOISE VARIATIONS	59
5.12 - FILE INFORMATION	60

SECTION 6 - DISPLAYING DATA	61
6.1 - DISPLAY MODES	61
6.2 - DISPLAY PREFERENCES	62
6.3 - AXIS SETUP	63
6.4 - ZOOM BOX	64
6.5 - ZOOMING & SCROLLING	65
6.5.1 - Zoom In & Zoom Out	65
6.5.2 - Scrolling	65
6.5.3 - Reset	65
6.6 - 2D DISPLAY MODE	66
6.6.1 - 2D display mode preferences	67
6.6.1.1 - Peak Search	68
6.6.1.1.1 - Peak Search Sensitivity	68
6.6.1.2 - Peak Labeling	68
6.6.1.2.1 - Labels on Peaks or Troughs	68
6.6.1.2.2 - Maximum Number of Labeled Peaks	68
6.6.1.2.3 - Format Labels	68
6.6.1.2.4 - Weighted Peak	68
6.6.1.2.5 - Pixel Peak	68
6.6.1.2.6 - Label Peaks in all Overlaid Spectra	68
6.6.2 - 2D with Peak Labeling	69
6.6.3 - Overlay	70
6.6.3.1 - Overlay & Keep	73
6.6.3.2 - Scale to Active	74
6.6.3.3 - Remove Overlay	74
6.7 - 3D DISPLAY MODE	75
6.7.1 - 3D display mode Preferences	76
6.8 - RESCALE	77
6.9 - DATA HISTOGRAM	78
6.10 - REGION OF INTEREST	80
6.10.1 - ROI Counter	83
6.10.2 - Hot Spot Approximation	83
6.10.3 - Recalculate	83
6.10.4 - Live Update	83
6.10.5 - Maximum Scans	83
6.10.6 - Plot Series	83
6.11 - TIME STAMP	84
6.12 - PLAYBACK	85

SECTION 7 - HANDLING FILES	86
7.1 - MENU OPTIONS	86
7.1.1 - Open	87
7.1.2 - Close	88
7.1.3 - Save	88
7.1.4 - Save As	88
7.1.5 - Export As	89
7.1.5.1 - ASCII	90
7.1.5.2 - AVI	91
7.1.5.3 - Bitmap	91
7.1.5.4 - GRAMS	91
7.1.5.5 - JPEG	91
7.1.5.6 - Raw Data	92
7.1.5.7 - Configuration Files	94
7.2 - PROGRAM SELECTION	95

SECTION 8 - CALIBRATION	96
8.1 - INTRODUCTION TO CALIBRATION	96
8.2 - MANUAL X-CALIBRATION	97
8.2.1 - Applying Calibration	98
8.2.2 - Calibrate	98
8.2.3 - When Manual X-Calibration goes wrong	99
8.2.3.1 - Data are Non-Montonic	99
8.2.3.2 - Too few points	100
8.2.4 - Undo	100
8.2.5 - Close	100
8.3 - X-CALIBRATION BY SPECTROGRAPH	101
8.3.1 - Setup Spectrograph	102
8.3.1.1 - Calibrate As Red-Blue	102
8.3.2 - Communications	103
8.3.2.1 - Other Spectrographs	103
8.3.2.2 - Reverse Spectrum	104
8.3.2.3 - X-Axis Labels & Units	104
8.3.2.4 - Change Units	105
8.3.3 - Center Wavelength / Center of Raman Shift	106
8.3.3.1 - Note on Raman Shift	106
8.3.4 - Offset	107
8.3.5 - Micrometer Setting	108
8.3.6 - Grating	108
8.3.7 - Close	108
8.3.8 - Processing Data via the Command Line	109
8.3.8.1 - Command Line	109
8.3.8.2 - Calculations	109
8.3.8.3 - Configure Calculations	109

SECTION 9 - WORKING WITH PROGRAMS	110
9.1 - WORKING WITH ANDOR BASIC PROGRAMS	110
9.1.1 - Command Line	110
9.1.2 - Program Editor Window	110
9.1.3 - Accessing the Edit functions	110
9.1.4 - Cut, Copy, Paste, Undo	111
9.1.5 - Search	111
9.1.6 - Replace	112
9.1.7 - Run Program	113
9.1.8 - Run Program by Filename	113
9.1.9 - Entering Program Input	113
SECTION 10 - TUTORIAL	114
10.1 - CALIBRATING DATA USING FLUORESCENT ROOM LIGHT	114
10.1.1 - Aim & Requirements	114
10.1.2 - Description	115

APPENDIX	117
A1.1 - GLOSSARY	117
A1.1.1 - PDA	117
A1.1.1.1 - InGaAs operation	117
A1.1.2 - Accumulation	117
A1.1.3 - Acquisition	117
A1.1.4 - A/D Conversion	117
A1.1.5 - Background	117
A1.1.6 - Counts	117
A1.1.7 - Dark Signal	118
A1.1.8 - Detection Limit	118
A1.1.9 - Exposure Time	118
A1.1.10 - Noise	119
A1.1.10.1 - Pixel Noise	119
A1.1.10.1.1 - Readout Noise	119
A1.1.10.1.2 - Shot Noise	120
A1.1.10.2 - Fixed Pattern Noise	120
A1.1.11 - Pixel	121
A1.1.12 - Quantum Efficiency / Spectral Response	121
A1.1.13 - Readout	121
A1.1.14 - Saturation	121
A1.1.15 - Scanning	121
A1.1.16 - Signal to Noise Ratio	121
A1.2- MECHANICAL DIMENSIONS	122
A1.3 - TERMS & CONDITIONS	123
A1.4 WARRANTIES & LIABILITY	124

SECTION 1 - ABOUT THE iDus InGaAs**1.1 - INTRODUCTION**

Thank you for choosing the Andor **iDus InGaAs**. Andor's **Photodiode Array (PDA)** exploits the processing power of today's desk-top computers. USB 2.0 connectivity ensures a seamless interface with the detector, as well as generating and receiving the signals you use to work with pulsed sources.

The system's hardware components and its comprehensive software provide speed and versatility that classical bench-top spectrometers cannot offer.

From the outset, the iDus has been designed for ease of use. The detector head is compact, requires no maintenance, and fits easily to popular spectrographs.

Under Solis software control, it serves it can cater for a broad range of spectroscopic applications.

The rich functionality of the Solis package is described in detail in the remainder of this User's Guide.

1.2 - WORKING WITH THE USERS GUIDE

This User's Guide describes the Andor iDus software and hardware. In the software, all the controls you need for an operation are grouped and sequenced appropriately in on-screen windows.

As far as possible, the descriptions in this User's Guide are laid out in sections that mirror the Windows Interface and use standard Windows terminology to describe the features of the user interface.

If you are unfamiliar with Windows, the documentation supplied with your Windows installation will give you a more comprehensive overview of the Windows environment.

1.3 - HELP

When the application is running, click the  button or press **F1** on the keyboard and the Andor Solis **HELP** dialog will open. Click on the area for which you require help and you will be provided with information relevant to the part of the application from which help was called.

In addition to the main On-Line Help, the system provides help that relates specifically to the Andor Basic programming language. If you are working in a Program Editor Window, context sensitive help is available on the "reserved words" of the programming language. To activate, with the cursor on or immediately after a reserved word, press **Ctrl + F1**.

So, whenever you're working with a particular window, you'll find a section in the User's Guide that sets that window in context, reminding you how the window is launched, letting you know what it can do, and telling you what other windows and operations are associated with it.

We hope you find use of our product rewarding. If you have any suggestions as to how our software, hardware and documentation might be improved, please let us know. You'll find our office addresses on **page 14**.

The software provides On-Line Help typical of Windows applications

1.4 - DISCLAIMER

THE INFORMATION CONTAINED HEREIN IS PROVIDED "AS IS" WITHOUT WARRANTY, CONDITION OR REPRESENTATION OF ANY KIND, EITHER EXPRESS, IMPLIED, STATUTORY OR OTHERWISE, INCLUDING BUT NOT LIMITED TO, ANY WARRANTY OF MERCHANTABILITY, NON-INFRINGEMENT OR FITNESS FOR A PARTICULAR PURPOSE.

IN NO EVENT SHALL ANDOR BE LIABLE FOR ANY LOSS OR DAMAGE, WHETHER DIRECT, INDIRECT, SPECIAL, INCIDENTAL, CONSEQUENTIAL OR OTHERWISE HOWSOEVER CAUSED WHETHER ARISING IN CONTRACT TORT OR OTHERWISE, ARISING OUT OF OR IN CONNECTION WITH THE USE OF THE INFORMATION PROVIDED HEREIN.

COPYRIGHT AND PROTECTIVE NOTICES:

The copyright in this document and the associated drawings are the property of Andor Technology plc and all rights are reserved. This document and the associated drawings are issued on condition that they are not copied, reprinted or reproduced, nor their contents disclosed.

The publication of information in this documentation does not imply freedom from any patent or proprietary right of Andor Technology plc or any third party.

1.5 - TRADEMARKS & PATENT INFORMATION

Andor, the Andor logo and iDus are trademarks of Andor Technology plc.

All other marks are property of their owners.

Changes are periodically made to the product and these will be incorporated into new additions of the manual.

1.6 - TECHNICAL SUPPORT

If you have any questions regarding the use of this equipment, please contact the representative* from whom your system was purchased, or:

Europe

Andor Technology
7 Millennium Way
Springvale Business Park
Belfast
BT12 7AL
Northern Ireland
Tel. +44 (0)28 9023 7126
Fax. +44 (0)28 9031 0792

Web:

http://www.andor.com/contact_us/support_request/

USA

Andor Technology
425 Sullivan Avenue - Suite 3
South Windsor
CT 06074
USA
Tel. +1 (860) 290-9211
Fax. +1 (860) 290-9566

Web:

http://www.andor.com/contact_us/support_request/

Asia-Pacific

Andor Technology (Japan)
4F NE Sarugakucho Building
2-7-6 Saragaku-Cho
Chiyoda-Ku
Tokyo 101-0064
Japan
Tel. +81-3-3518 6488
Fax. +81-3-3518 6489

Web:

http://www.andor.com/contact_us/support_request/

China

Andor Technology
Room 502
Yu Yang Zhi Ye Building
A2 Xiao Guan Bei
Chaoyang District
Beijing 100029
China
Tel. +86-10-5129-4977
Fax. +86-10-6445-5401

Web:

http://www.andor.com/contact_us/support_request/

***NOTE: THE CONTACT DETAILS FOR YOUR NEAREST REPRESENTATIVE CAN BE FOUND ON OUR WEBSITE.**

1.7 - COMPONENTS

The main components of the Andor iDus system are as follows:

- Detector Head
- USB 2.0 compatible cable
- **PS-25 Power Supply Unit (PSU)**
- Solis software in CD format
- Andor Users Guides also in CD format & Andor Basic Programmer's Guide

1.7.1 - Optional Extras

- Spectrograph
- Mounting Flanges
- Shutter & Shutter Driver SD-166

1.7.2 - Camera

The camera (**figure 1**) contains the following items:

- InGaAs Sensor
- Pre-Amplifier & 16-bit analog to digital converter
- Cooling circuitry & Thermoelectric Cooler
- Input & output connectors.

The camera can be attached to a Spectrograph or other optical device for acquiring data.



Figure 1: iDus InGaAs camera

The two water pipe connectors allow water to be passed through the head to assist cooling as required.

The PS-25 PSU can be used to achieve maximum cooling and has two settings, namely **STANDARD COOLING** or **DEEP COOLING**. The connection to the iDus is also made via a 5-pin DIN socket.



Figure 2: Optional PS-25 PSU

1.7.4 - Software

Software is supplied on a CD or USB stick.

NOTE: The minimum computer Operating System is either Windows (XP, Vista or 7) or Linux. It also needs to be USB 2.0 compatible.

1.7.5 - Manuals

A full set of all Andor equipment manuals in CD format is supplied with each Andor PDA system.

1.7.6 - Spectrograph (optional)

A Spectrograph is usually required for spectroscopic measurements. A spectrograph and PDA combination (an optical spectral analyzer) may be used to replace the traditional motor-driven monochromator and photomultiplier tube. In a spectrograph, a wide aperture replaces the exit slit found in the monochromator.

The spectrograph causes a dispersed spectrum to be projected as a continuous band of wavelengths on to a PDA at the focal plane. In order that the detector head can be positioned at the focal plane, the correct mounting flange must be attached to the spectrograph. In addition, you must ensure that an appropriate entry slit and grating are used for the particular spectral analysis you want to undertake.

1.7.7 - Mounting Flanges (optional)

Mounting Flanges, or face plates, are metal plates which allow the detector head to be positioned at the focal plane of a spectrograph. Andor can provide mounting flanges for a wide range of spectrographs, in imaging and non-imaging format, with focal lengths ranging from 125 cm to 1 m if required.

Consult the spectrograph's instruction manual to ensure that you are using the correct flange.

1.8 - SAFETY PRECAUTIONS & SAFE CAMERA OPERATION**1.8.1 - Care of the camera****WARNINGS:**

1. The camera is a precision scientific instrument containing fragile components. Always handle with the care necessary for such instruments.
2. There are no user serviceable parts inside the camera. If the head is opened the warranty will be void.
3. To prevent accidental internal damage to the camera, objects small enough to enter the slots on the sides of camera should be placed well away from these slots.

1.8.2 - Environmental conditions

- 5V DC at 3.0A
- 7.5V DC at 4.0A
- ±15V DC at 0.2A
- Indoor use only
- Altitudes up to 2000 m
- Temperature 5°C to 40°C
- Maximum Relative Humidity 80% for temperatures up to 31°C, decreasing linearly to 50% relative humidity at 40°C
- Other voltage fluctuations as stated by the manufacturer
- Overvoltage category 1
- Pollution Degree 2

1.8.3 - Additional statement regarding equipment operation

IF THE EQUIPMENT IS USED IN A MANNER NOT SPECIFIED BY ANDOR TECHNOLOGY plc, THE PROTECTION PROVIDED BY THE EQUIPMENT MAY BE IMPAIRED.

1.8.4 - Working with electronics

The computer equipment that is to be used to operate the camera should be fitted with appropriate surge/EMI/RFI protection on all power lines. Dedicated power lines or line isolation may be required for some extremely noisy sites. Appropriate static control procedures should be used during the installation of the system. Attention should be given to grounding. The circuits used in the detector head are extremely sensitive to static electricity and radiated electromagnetic fields, and therefore they should neither be used nor stored in close proximity to EMI/RFI generators, electrostatic field generators, electromagnetic or radioactive devices, or other similar sources of high energy fields. Some examples of equipment which can cause problems are as follows:

- Arc welders
- Plasma sources
- Pulsed discharge optical sources
- Radio frequency generators
- X-ray instruments

Operation of the system close to intense pulsed sources (arc lamps, lasers, xenon strobes, etc.) may compromise performance if shielding is inadequate. InGaAs arrays can be susceptible to pickup of unwanted electronic noise, this is because they contain built in electronic readout circuits. In laboratories where the main electricity supply is at 50 Hz, a beating frequency may be observed when running the camera at readout rate similar to this. This may exhibit itself as baseline oscillation.

If observed this issue this can be avoided by ensuring the device the camera is connected to is adequately grounded or connected electrically to the body of the camera.

1.8.5 - Head overheating

Care should be taken to ensure that the camera does not overheat, as this can cause system failure. Overheating may occur if either of the following occur:

- The air vents on the sides of the camera are accidentally blocked or there is insufficient or no water flow
- You are using air cooling and have selected **Deep Cooling**. **NOTE: Air cooling may not be possible if the ambient air temperature is over 20°C.**

To protect the detector from overheating, a thermal switch has been attached to the heat sink. If the temperature of the heat sink rises above 47°C, the current supply to the cooler will cut out and a buzzer will sound. Once the camera has cooled, the cut-out will automatically reset.

Please see next page for further information on Cooling.

The PDA is cooled using a thermoelectric (**TE**) cooler. TE coolers are small, electrically powered devices with no moving parts, making them reliable and convenient. A TE cooler is actually a heat pump, i.e. it achieves a temperature difference by transferring heat from its 'cold side' (the PDA-chip) to its 'hot side' (the built-in heat sink). Therefore the minimum absolute operating temperature of the PDA depends on the temperature of the heat sink. Our vacuum design means that we can achieve a maximum temperature difference of over 95°C (with optional PS-25), a performance unrivalled by other systems. The maximum temperature difference that a TE device can attain is dependent on the following factors:

- Heat load created by the PDA
- Operating current

The heat that builds up on the heat sink must be removed and this can be achieved in one of two ways:

1. **Air cooling:** a small built-in fan forces air over the heat sink
2. **Water cooling:** external water is circulated through the heat sink using the water connectors on the top of the head. This type of cooling is specially recommended for InGaAs cameras.

All Andor PDA systems support both cooling options. Whichever method is being used, it is not desirable for the operating temperature of the PDA simply to be dependent on or vary with the heat sink temperature. Therefore a temperature sensor on the PDA, combined with a feedback circuit that controls the operating current of the cooler, allows stabilisation of the PDA to any desired temperature within the cooler operating range.

1.8.6.1 - Air cooling

Air cooling is the most convenient method of cooling, but it will not achieve as low an operating temperature as water cooling (see below). Even with a fan (see **NOTE 2.** below), a heat sink typically needs to be 10°C hotter than the air (room) temperature to transfer heat efficiently to the surrounding air. Therefore the minimum PDA temperature that can be achieved will be dependent on the room temperature.

NOTES:

1. **When air-cooling, the camera body can reach temperatures in excess of 40 °C. InGaAs sensors will detect this black body radiation and it will appear as dark signal. It is therefore recommend to always utilize water cooling.**
2. **The fan operates continuously unless overwritten by the user via the software.**

1.8.6.2 - Water cooling

A flow of water through the heat sink removes heat very efficiently, since the heat sink is never more than 1°C hotter than the water. With this type of cooling, the minimum temperature of the PDA will be dependent only on the water temperature and not on the room temperature. Water cooling, either chilled through a refrigeration process or re-circulated (which is water forced air cooled then pumped) allows lower minimum operating temperatures than air cooling. **IMPORTANT NOTE: SEE INFORMATION ON CONDENSATION BELOW.**

The table below is a guide to the minimum achievable operating temperatures for various room & water temperatures. Performance of individual systems will vary slightly.

Table 1: Cooling performance

Air-cooled (ambient air @ 20°C)	-70°C
Water-cooled (@ 10°C, 0.75 l / min)	-90°C

NOTES:

- 1. The relationship between the air temperature and the minimum PDA temperature in the table is not linear. This is because TE coolers become less efficient as they get colder.**
- 2. Systems are specified in terms of the minimum dark signal achievable, rather than absolute temperature. For dark signal specifications, please refer to the specification sheet for your camera.**

1.8.6.3 - Condensation

NEVER USE WATER THAT HAS BEEN CHILLED BELOW THE DEW POINT OF THE AMBIENT ENVIRONMENT TO COOL THE CAMERA. You may see condensation on the outside of the camera body if the cooling water is at too low a temperature or if the water flow is too great. The first signs of condensation will usually be visible around the connectors where the water tubes are attached. If this occurs carry out the following actions:

1. Switch off the system
2. Wipe the camera with a soft, dry cloth. **NOTE: It is likely there will already be condensation on the cooling block and cooling fins inside the camera.**
3. Set the camera aside to dry for several hours before you attempt reuse.
4. Before reuse blow dry gas through the cooling slits on the side of the camera to remove any residual moisture.
5. Use warmer water or reduce the flow of water when you start using the device again. **NOTE: This is not an issue when using a Recirculator which eliminates the dew point problem.**

1.8.6.4 - Dew Point graph

The Dew Point graph below plots the relationship between **Relative Humidity** and **Dew Point** at varying ambient temperatures. This can be used to calculate the minimum temperature the cooling water should be set to.

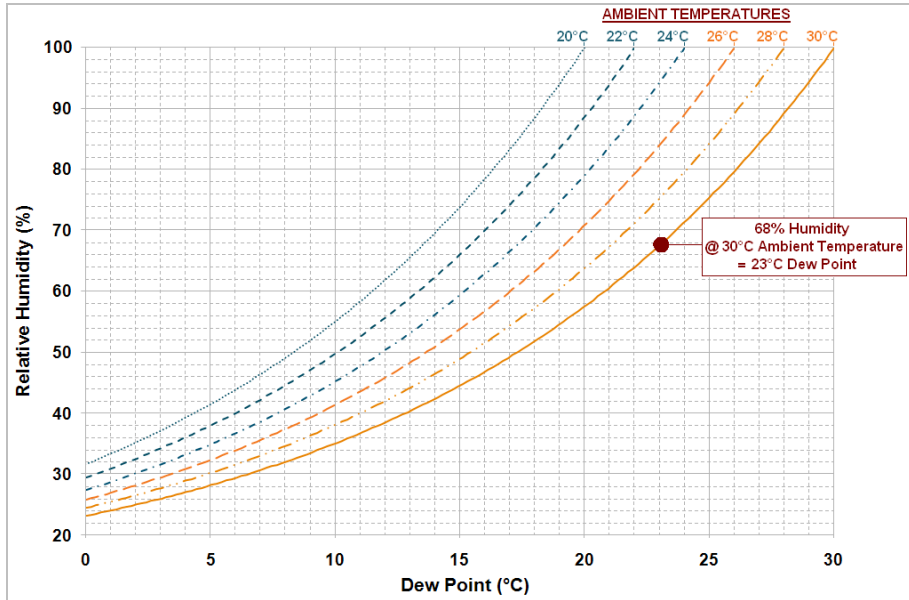
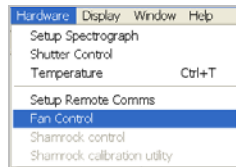

Figure 3: Dew point graph

For example, using a system with the PS-25 you will need 10°C cooling water to guarantee performance down to -90°C. In the relatively dry atmosphere of an air-conditioned lab, cooling water at 10°C should not present any problems. However, in humid conditions (such as exist in some parts of the world) condensation may occur, resulting in damage to the camera. In such conditions you will have to use warmer water (20°C or even higher if it is very humid). The minimum PDA temperature in this example would then be limited to between -70°C to -80°C.

1.8.6.5 - Fan settings

The speed of the cooling fan can also be controlled. Select **Fan Control** from the **Hardware** drop-down menu as shown:



The **Fan speed** dialog box will appear:

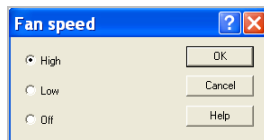

Select the speed you require as necessary (this may affect the cooling ability of the PDA).

NOTE: After changing from High to Low, it may be necessary for the camera temp to stabilize before acquiring data. However for optimum performance it is recommended to leave the fan setting at High.

There is significant circuitry on the InGaAs sensor which is photo-sensitive. When the camera is used on a spectrograph with discrete spectral lines it is not expected that this will cause any problem, but if the sensor is exposed to a large amount of light there may be some effect on the performance of the camera. Stray light on the gold bond wires on the sensor should also be minimised in order to reduce the possibility of reflections.

SECTION 2 - INSTALLATION**2.1 - COMPUTER REQUIREMENTS**

The minimum computer requirement for correct iDus InGaAs operation is as follows:

- 3.0 GHz single core or 2.4 GHz multi core processor
- 2 GB RAM
- 100 MB free hard disc to install software (at least 1GB recommended for data spooling)
- USB 2.0 High Speed Host Controller capable of sustained rate of 40MB/s
- Windows (XP, Vista and 7) or Linux

2.2 - INSTALLING THE SOFTWARE & USB DRIVER

1. Terminate & exit any programmes which are running on the PC.
2. Insert the Andor CD. The **InstallShield Wizard** now starts. If it does not start automatically, run the file **setup.exe** directly from the CD then follow the on-screen prompts that then appear, e.g.:

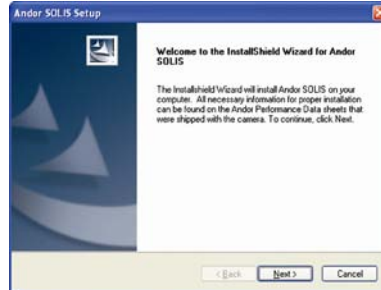

3. Click **Next >** and the following dialog box appears:

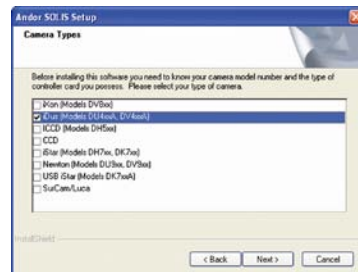

4. Tick the **iDus** selection as shown above then click **Next>** and the following dialog box appears:

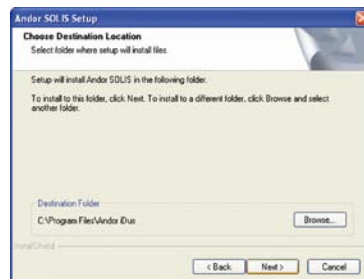

5. Click **Next >** (alternatively, click on **Browse...**, choose your own file destination then click **Next >**).

The following dialog box appears:

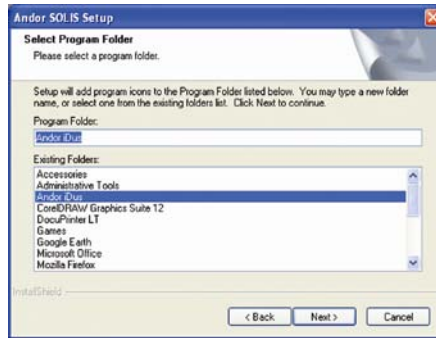

6. Select **Andor iDus** then click **Next >** again and the following dialog box appears:

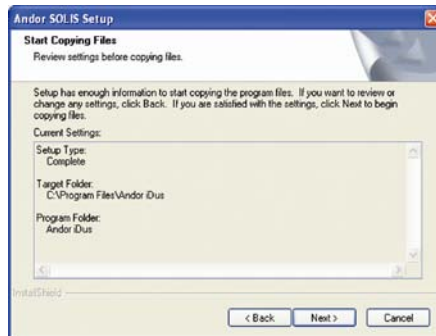

7. Click **Next>** and an update progress bar will begin appear, e.g.:

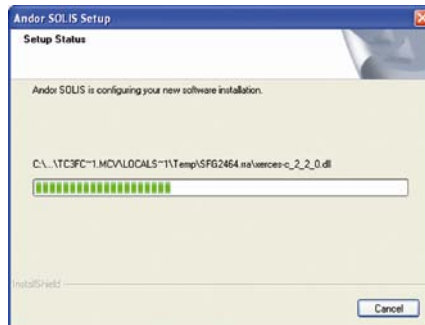

8. When the update progress bar stops, the following dialog box appears:

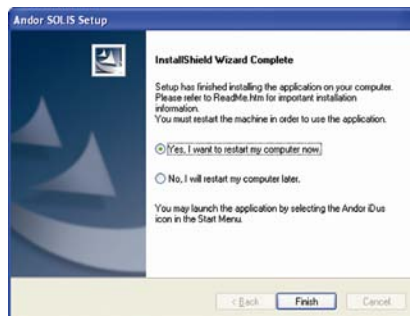

9. Select the 'Yes, I want to restart my computer now' option then click **Finish**.

10. A message similar to the following may appear:

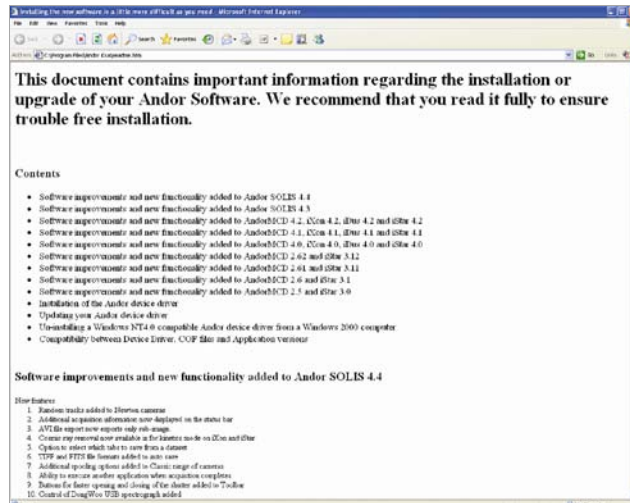

11. Please read the message and observe any important information relevant to your system, then restart the PC if necessary.

After the PC has been restarted, the **Solis** icon  should now be installed on your desktop. Click on this to start the application.

Connect the elements of your system in the sequence that follows:

1. Power up the PC
2. Power up the camera with the supplied PSU
3. Connect the USB cable between the detector head & any available USB port on the PC



Figure 4: iDus backplate showing connections

There are 6 connection points on the rear of the iDus as shown above. There are 3x industry-standard SMB (Sub Miniature B) connectors labelled from top to bottom as follows:

- **Fire**
- **Ext Trig**
- **Shutter**

These are used to send or receive Triggering and Firing signals, which are described later in this manual. The SMB outputs (**Fire & Shutter**) are CMOS compatible & Series terminated at source (i.e. in the camera head) for 50Ω cable. **NOTE: The termination at the customer end should be high impedance (not 50Ω) as an incorrect impedance match could cause errors with timing and triggering. The SMB Ext Trig input is TTL level & CMOS compatible and has 470Ω impedance.**

The other rear connectors are as follows:

- **USB 2.0:** to connect the USB 2.0 cable between the camera and a PC.
- **I²C:** The pin connections for the five-way I²C connector used on the iDus are shown below:

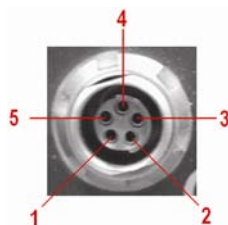

Figure 5: I²C connection (facing in) with pin-outs

PIN	FUNCTION
1	SHUTTER (TTL)
2	I ² C CLOCK
3	I ² C DATA
4	+5V
5	GROUND

**Fischer Clic-Loc™
SC102A054-130**

- **Power:** a 5-pin DIN plug is fitted for power connection to the PSU

When the camera is first connected, the following screen may appear:



1. Select the 'Yes, this time only option' then click **Next>** and the following screen appears:



2. Select the 'Install the software automatically (Recommended)' option then click **Next>**. The following screens appear:

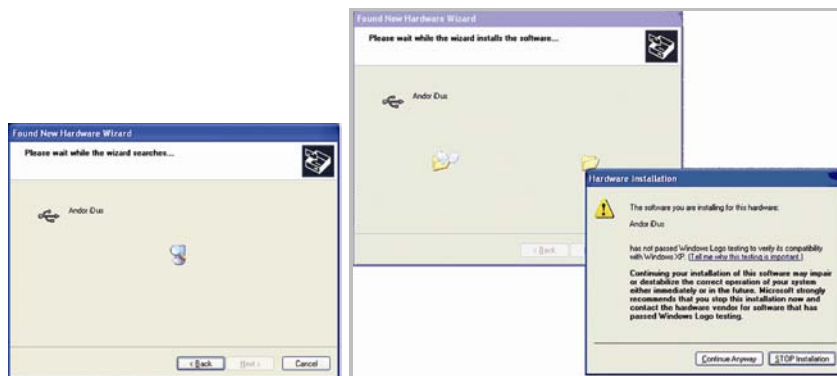

3. Click the **Continue Anyway** button. The software will continued to be installed, e.g.:

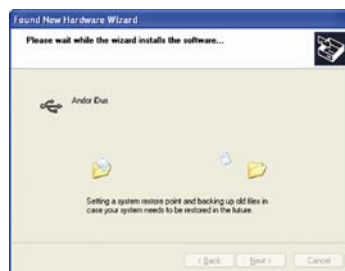

4. When the installation is complete, the following dialog box appears:

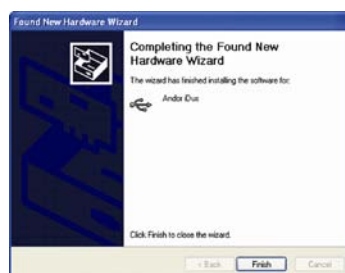

5. Click **Finish** to complete the install.

SECTION 3 - USING THE iDus InGaAs

3.1 - STARTING THE APPLICATION

On the desktop, click on the  icon and the Andor **solis** splash screen appears briefly, e.g.:





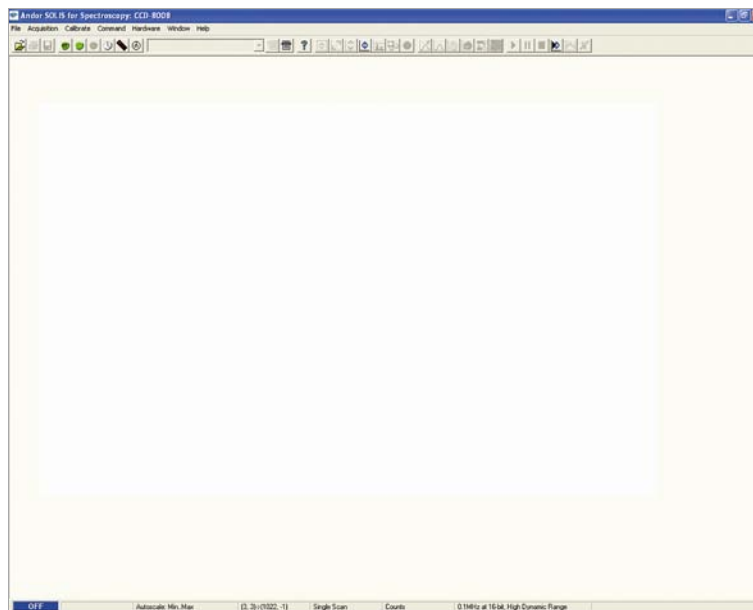































The **Main Window** then appears, e.g.:



The Main Window is your “entry point” to the system. The menu options that you select from either execute functions directly, or launch further windows/dialog boxes that let you select the functionality you require. Some menu options on the Main Window are also represented as easy-to-use radio buttons, as shown in **Table 2** below:

Table 2: Main Window buttons

ICON	TITLE	ICON	TITLE	ICON	TITLE
	Open		Select Sub-image Area		Change False Color Palette
	Print		Select Autoscale Area		Time Stamp
	Save		Reset		Play
	Real Time		Rescale		Pause
	Take Signal		Acquisition Autoscale		Stop
	Abort Acquisition		Data Histogram		Playback Autoscale
	Setup Acquisition		Region Of Interest		Baseline Correction
	Run-Time		File Information		Periodic Table
	Shutter		2D display mode (with Peak Labels)		Temperature Control (Off)
	Run Program		2D display mode		Temperature Control (On)
	Command Line		3D display mode		
	Help		Image display mode		

NOTE: Some menu titles and buttons appear on the main window only under certain circumstances as shown on the next page.

- The Display menu and its associated buttons will not appear until you open a Data Window, e.g.:

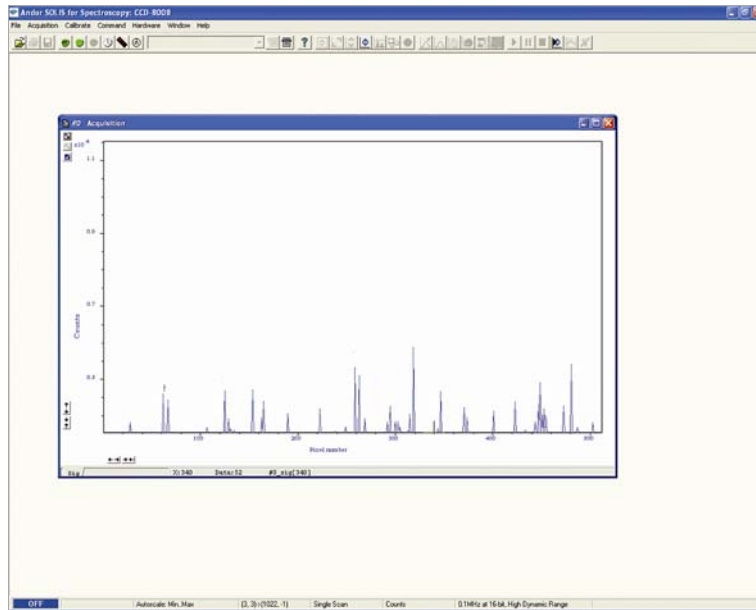

- The Edit & Search menus and their associated buttons appear only when a Program Editor Window is active, e.g.:

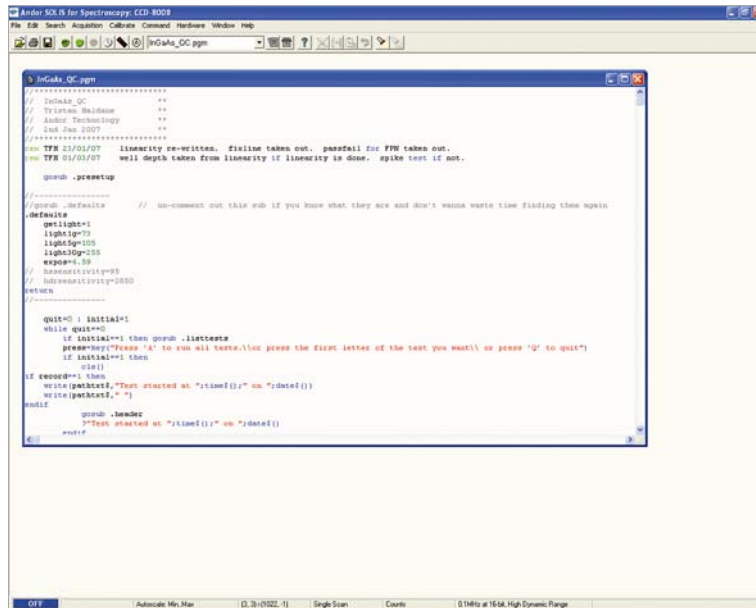

```

Andor SOXIS for Spectrometry CCD 8009
File Edit Search Acquisition Calibrate Command Hardware Windows Help

iDus_InGaAs.pgm

iDus_InGaAs.pgm
*****
// iDus_InGaAs.pgm
// To start: Mainframe
// Andor Technology
// 2nd Jan 2007
//*****
com TFM 23/01/07 Linearity re-written. Fixline taken out. passFail for FTW taken out.
com TFM 01/03/07 well Depth taken from linearity if linearity is done. spike test if not.

gorun .presetup

//*****
//gorun .defwrite // Un-comment out this sub if you know what they are and don't waste time finding them again
.defwrite
getlight=1
lightsp=75
lightsp=100
lightsp=150
expos=1.00
// Intensity=95
// Intensity=2000
return
//*****
quit=1 initial=1
while quit=0
  if initial=1 then gorun .listtests
  presentry("Press 'q' to run all tests.\n\n press the first letter of the test you want\ or press 'q' to quit")
  if initial=1 then
    quit
  if record=1 then
    write(packtext,"Test started at :",time()," on :",date())
    write(packtext," ")
  endif
  gorun .header
  >>Test started at :",time()," on :",date()
  write
endif
  
```

Hot keys (or shortcuts) as shown in Tables 3, 4 & 5 enable you to work with the system directly from the keyboard, rather than via the mouse.

Table 3: Data Acquisition Hot Keys

Key stroke(s)	Description
F5	Take signal
F6	Autoscale Acquisition
Ctrl + B	Take background
Ctrl + R	Take reference
Esc	Abort Acquisition

Table 4: Data Window Hot Keys

		Display mode		
		2D	3D	Image
+	Expand ('Stretch') data-axis	✓	✓	✓
-	Contract ('Shrink') data-axis	✓	✓	✓
Ins	If maintain aspect ratio off, expand x-axis. If maintain aspect ratio on, expand x-axis and y-axis.	✓	✓	✓
Del	If maintain aspect ratio off, contract x-axis. If maintain aspect ratio on, contract x-axis and y-axis.	✓	✓	✓
/	On image, if maintain aspect ratio off, expand y-axis. On image, if maintain aspect ratio on, expand x-axis and y-axis.			✓
Home	Move cursor furthest left	✓	✓	✓
End	Move cursor furthest right	✓	✓	✓
PgUp	Scroll up through tracks	✓	✓	✓
PgDn	Scroll down through tracks	✓	✓	✓
Shift + PgUp	Move to next image in series	✓	✓	✓
Shift + PgDn	Move to previous image in series	✓	✓	✓
Left Arrow	Move cursor left	✓	✓	✓
Right Arrow	Move cursor right	✓	✓	✓
Up Arrow	Scroll trace up (on image: move cursor up)	✓	✓	✓
Down Arrow	Scroll trace down (on image: move cursor down)	✓	✓	✓
Shift + Left Arrow	Scroll trace/image left	✓	✓	✓
Shift + Right Arrow	Scroll trace/image right	✓	✓	✓
Ctrl + Left Arrow	Peak search left	✓	✓	✓
Ctrl + Right Arrow	Peak search right	✓	✓	✓
F7	Toggle Palette	✓	✓	✓
F8	Reset	✓	✓	✓
F9	Rescale	✓	✓	✓
Alt + F9	Toggle Rescale Mode	✓	✓	✓
Ctrl + F9	Scale to Active (See Displaying Data section)	✓	✓	✓
F10	File information	✓	✓	✓

Table 5: Andor Basic Programming Language Hot Keys

Key stroke(s)	Description
Ctrl + P	New program
Ctrl + E	Run program
Esc	Abort acquisition / program
Ctrl + L	Command line
Ctrl + F1	Context sensitive help on reserved words in the Andor Basic programming language is available if you are using the Program Editor Window.

SECTION 4 - PRE-ACQUISITION

4.1 - SETTING TEMPERATURE

For accurate readings, the PDA should first be cooled, as this will help reduce dark signal. To do this, either select the **Temperature** option from the **Hardware** drop-down menu on the Main Window:



or click the **OFF** button in the bottom-left of the screen.

This will open up the Temperature Control dialog box :

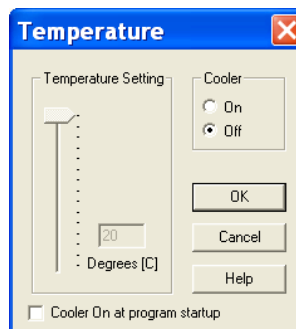

Select the **On** radio button.

The **Degrees (C)** field in the **Temperature Setting** section will now be highlighted in blue and the **Cooler** will be indicated as **On** as shown below. To adjust the temperature, either type in the new figure in the **Degrees (C)** box or move the slider bar down or up.

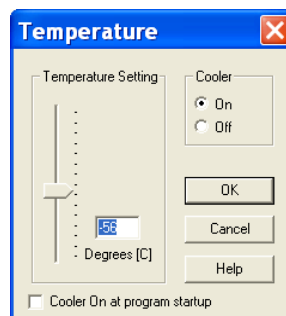

Once the desired temperature has been selected, click OK.

The dialog box will disappear and the Temperature Control button in the bottom-left of the screen will show the current temperature highlighted in red e.g.: **-45°C**

This figure will change as the head cools. Once the head has reached the desired temperature, the highlighted area changes to blue. You can also select the option to have the Cooler switched on as soon as you start the application. This is selectable in the bottom-left of the Temperature dialog box.

PLEASE REFER TO PAGES 20 - 22 FOR DETAILS OF MINIMUM ACHIEVABLE TEMPERATURES AND IMPORTANT ADVICE ON AVOIDING OVERHEATING.

To select the mode of acquisition prior to data capture, you can either click the  button, key in **Ctrl+A** from the keyboard or select **Setup Acquisition** from the **Acquisition** drop-down menu:

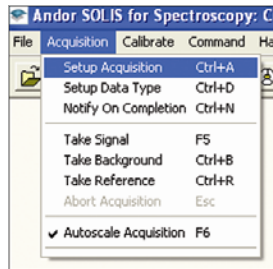

The Setup Acquisition Dialog box appears, e.g.:

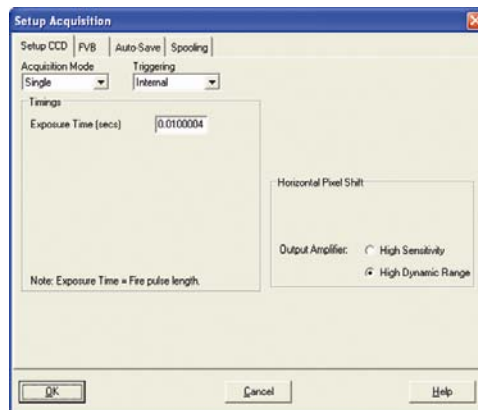

The following options are available in the Setup CCD area:

ACQUISITION MODE

- Single
- Accumulate
- Kinetic

TRIGGERING

- Internal
- External
- External Start (Accumulate, & Kinetic modes only)

HORIZONTAL PIXEL SHIFT

- **Output Amplifier** : High Sensitivity (**HS**) or High Dynamic Range (**HDR**)

Depending on which combination of Acquisition, & Triggering modes are selected, other additional Timings options become available. **Table 6** on the next page lists the parameters for which you may enter a value in the appropriate text box. As you select an Acquisition Mode you will notice that you are able to enter additional exposure-related and timing parameters in a column of text boxes.

Certain text boxes become active as you select each Acquisition Mode. Minimum default values are also shown in the text boxes.

NOTE: The value you enter in one text box may affect the minimum permissible value in another text box. The system updates the display of minimum permissible values accordingly.

Table 6: Acquisition modes

Acquisition Mode	Exposure Time	No. of Accumulations	Accumulate Cycle Time (secs)	Kinetic Series Length	Kinetic Cycle Time
Single	✓				
Accumulate	✓	✓	✓		
Kinetic	✓			✓	✓

Auto-Save allows you to set parameters and controls for the auto saving of acquisition files thus removing the worry of lost data and files. To select, click on the **Auto-Save** tab on the **Setup Acquisition** dialog box .The Auto-Save dialog box appears, e.g.:

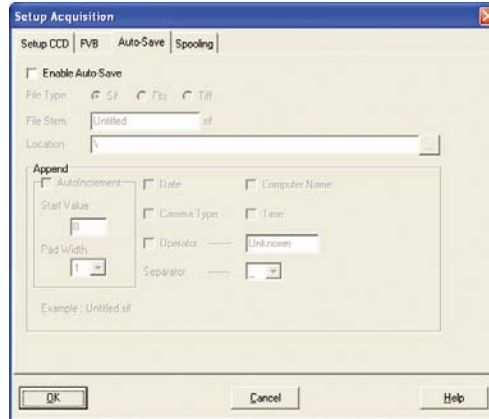

Tick the **Enable Auto-Save** box. If selected, acquisitions will be saved automatically when each one is completed. Each subsequent auto-saved file will over-write the previously auto-saved one.

There is also an **Auto-Increment** On/Off tick box. This allows a number to also be appended to the main Stem Name. This number is automatically incremented each time a file is saved. This time the auto-saved files will not overwrite any previous auto-saved files. In the Auto-Save dialog box, a Stem Name may be entered. This is the main root of the name that the acquisition is to be saved as.

The Stem Name can be appended with a number of details:

- **Operator name (supplied by user)**
- **Computer name**
- **Camera type**
- **Date**
- **Time**

Any combination of these may be selected by activating the relevant tick box, e.g.:

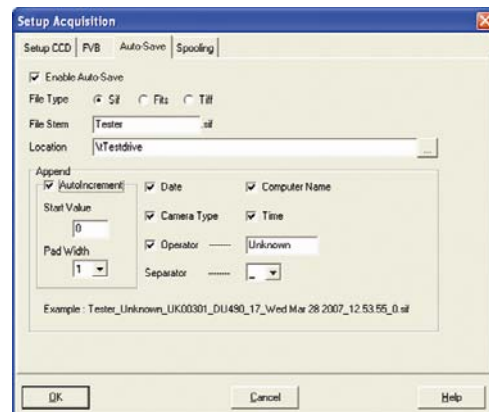

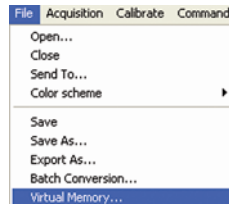

NOTE: This function will only Auto-save Single Scan, Kinetic Series or Accumulated images.

In addition to the Spooling function, it can also be useful to have the **Virtual Memory (VM)** function enabled. This will speed up the retrieval of large data sets and allow larger data sets to be acquired. This works by buffering data in the Hard Drive of the PC. To switch on, select the **Virtual Memory...** option from the **File** menu, e.g.:

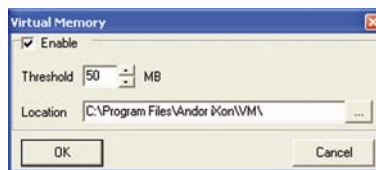

This will open the **Virtual Memory** dialog box:



Tick the **Enable** box and select the required **Threshold**. The data is normally saved to the default directory shown in the Location field. Alternatively, you can click on the  button and choose a different area to save the data. Click Ok and the data will be saved during acquisition.

NOTE: It is recommended to have the option activated for images >50Mb.

Andor Solis software allows you to spool acquisition data direct to the hard disk of your PC. This is particularly useful when acquiring a series of many images. The amount of data generated by a Kinetic Series of 1000 acquisitions, for example, is huge and more than most PC RAM can handle. To select, click on the **Spooling** tab and the Spooling dialog box appears e.g.:

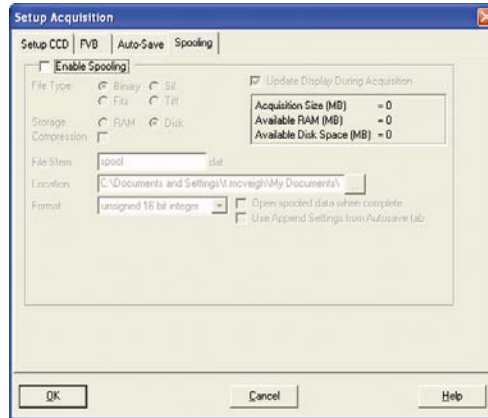

With the spooling function enabled, data is written directly to the hard disk of you PC, as it is being acquired. To enable the spooling function on your software, tick **Enable Spooling** on the Spooling dialog box, e.g.:

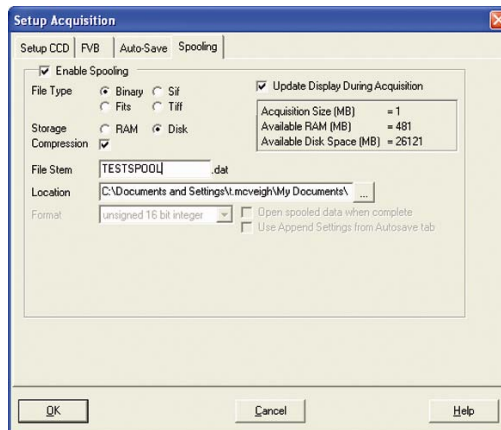

You must also enter a stem name, and also select a location for the for this spooled data file, e.g.:

NOTE: Spooling large amounts of data straight to hard disk for later retrieval requires a hard disk of sufficient read-write speed. Andor recommends only very high-speed hard disk drives be used for this type of operation.

SECTION 5 - ACQUIRING DATA

5.1 - INITIAL ACQUISITION

To start an initial data acquisition you can either click the  button on the Main Window, press F5 on the keyboard or select the Take Signal option from the Acquisition drop-down menu as shown:

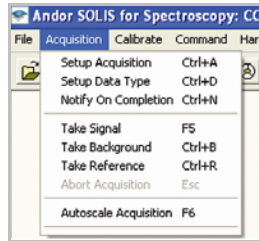

The Data Window opens, (labeled #0 Acquisition) and displays the acquired data, according to the parameters selected on the Setup Acquisition Dialog box. e.g.:

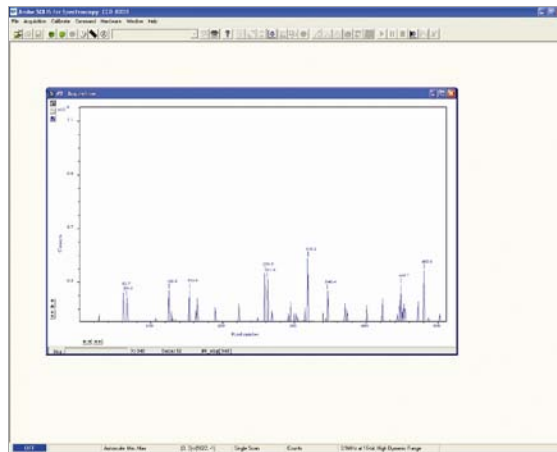

#n uniquely identifies the data set while the data set is being displayed and is temporary. It ceases to be associated with the data set once you close all data windows bearing the same #n. It is often referred to as an Acquisition Window. **NOTE: Each data window has the same name and #n (which identify the Data Set), but a unique number, following the data set name, to identify the window itself. Data can be modified only in a data window labeled with the name and the #n of the data set to which the data belong. If you modify a data set and attempt to close the data window, you will be prompted to save the data set to file.**

If you have selected Accumulate or Kinetic as the Acquisition Mode, new data will continue to be acquired and displayed until you carry out one of the following actions:

- Select Abort Acquisition from the Acquisition drop-down menu
- Click the  button
- Press the <ESC> key

This stops any data capture process that may be under way. Information on how to capture & view more detailed data is contained in the pages that follow.

Raw data from the camera should not be used for calculations. As each pixel has its own amplifier and most sensors will have separate output amplifiers for odd and even pixels, background correction should always be performed to remove DC offsets. Where possible, flat fielding should also be used to compensate for gain differences.

5.3- DATA TYPE SELECTION

You can select the type of information that you want the system to compute and display whenever you perform the Take Signal function. When the Setup Data Type option of the Acquisition drop-down menu is selected, the Data Type dialog box opens:

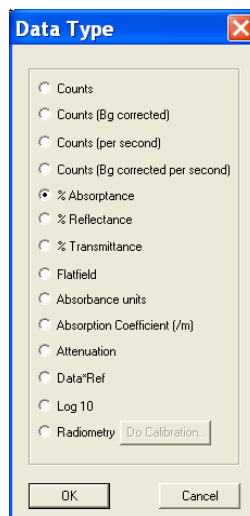

The descriptions of the data types are shown in **Table 7** which follows on the next 2 pages. The acquired data are presented under the **Sig** tab of an Acquired Data Window.

The data type selected will also determine whether you need to take a background and/or a reference scan using the **Take Background** and/or **Take Reference** options. These options are described in more detail on **page 47**).

5.2.1 - Definitions of data types

- **Signal:** data in uncorrected Counts
- **Background:** data in uncorrected Counts, acquired in darkness
- **Reference:** background corrected data. Reference data are normally acquired from the light source, without the light having been reflected from or having passed through the material being studied

Table 7 - Data types

OPTION	FUNCTION
Counts	<p>Counts represent raw, digitized data (i.e. no calculations have been performed on the data) from the PDA detector's analog to digital (A/D) converter.</p> <p>Please refer to the detailed performance sheet accompanying your particular PDA detector for the number of electrons that correspond to 1 count.</p>
Counts (Bg corrected)	<p>Counts (Background Corrected) is digitized Data from the PDA detector's analog to digital (A/D) converter, where Background (or dark signal) has been removed.</p> <p>Counts (Bg. Corrected) = Signal - Background</p>
Counts (per second) Count (Bg corrected per second)	<p>Counts ÷ Exposure Time.</p> <p>Counts (Bg corrected) ÷ Exposure Time.</p>
%Absorptance	<p>Represents the light absorbed by an object.</p> <p>If Reference is the background corrected incident intensity, and Signal - Background the transmitted intensity (i.e. the intensity of light which has passed through the material being examined), then:</p> <p>% Absorptance = 100 x (1 - (Signal - Background) / Reference)</p>
%Reflectance	<p>Represents the light reflected by an object.</p> <p>If Reference is the background corrected incident intensity, and Signal - Background the reflected intensity (i.e. the intensity of light which has been reflected from the material being examined), then:</p> <p>% Reflectance = 100 x (Signal - Background) / Reference</p>
%Transmittance	<p>Represents the light transmitted by an object.</p> <p>If Reference is the background corrected incident intensity, and Signal - Background the transmitted intensity (i.e. the intensity of light which has been transmitted through the material being examined), then:</p> <p>% Transmittance = 100 x (Signal - Background) / Reference</p>
Flatfield	<p>Flatfield is used to remove the pixel-to-pixel variations that are inherent to InGaAs sensors.</p> <p>If Reference is the background corrected incident intensity, the Signal is divided by the Reference so:</p> <p>Flatfield = M x Signal / Reference</p> <p>Where M is the Mean of Reference.</p>

Table 7 - Data types (continued)

OPTION	FUNCTION
Absorbance units	<p>A measure of light absorbed by an object (i.e. they represent the object's Optical Density - OD).</p> <p>If Reference is the background corrected incident intensity, and Signal - Background the transmitted intensity (i.e. the intensity of light which has passed through the material being examined), then Transmission = (Signal - Background) / Reference.</p> <p>Absorbance Units are defined as $\text{Log}_{10} (1 / \text{Transmission})$, therefore: Absorbance Units = $\text{Log}_{10} (\text{Reference} / (\text{Signal} - \text{Background}))$.</p>
Absorption Coefficient (/m)	<p>Indicates the internal absorptance of a material per unit distance (m). It is calculated as -loge t, where t is the unit transmission of the material and loge is the natural logarithm.</p> <p>If Reference is the background corrected incident intensity, and Signal - Background the transmitted intensity (i.e. the intensity of light which has passed through the material being examined), then:</p> <p>Transmission = (Signal - Background) / Reference</p> <p>and:</p> <p>Absorption Coefficient = -loge ((Signal - Background) / Reference)</p>
Attenuation	<p>A measurement, in decibels, of light absorbed due to transmission through a material. Decibels are often used to indicate light loss in fiber optic cables, for instance. If Reference is the background corrected incident intensity, and Signal - Background the transmitted intensity (i.e. the intensity of light which has passed through the material being examined), then:</p> <p>Attenuation = $10 \times \log_{10} ((\text{Signal} - \text{Background}) / \text{Reference})$</p>
Data*Ref	<p>Allows you to 'custom modify' the background corrected signal:</p> <p>Data x Ref = (Signal - Background) x Reference Store Value</p> <p>See the Andor Basic Programming Manual for similar operations.</p>
Log 10	<p>Calculates the logarithm to the base 10 of the background corrected signal counts. Log Base 10 = $\log_{10} (\text{Signal} - \text{Background})$</p>
Radiometry	<p>Allows you to calculate values for radiance or irradiance. The system requires that you supply calibration details. This is an optional extra and must be ordered separately.</p>
Counts (R.E.C.)	<p>Radiometric calculation for Mechelle spectrograph. Supplied with Mechelle systems.</p>

As an example, the system will compute % Absorptance as:

$$100 \times (1 - (\text{Signal} - \text{Background}) / \text{Reference})$$

The illustration below shows a typical use of Background, Reference and Signal for computations such as %Absorptance or %Transmittance:

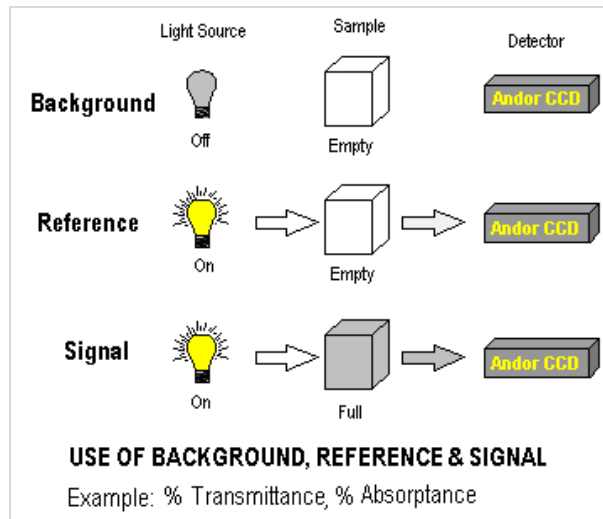

The default data type (used when you capture data and have not explicitly made a selection from the Data Type dialog box) is **Counts**.

- If you select any data type **other than** Counts or Counts (Bg Corrected) you will have to perform Take Background and Take Reference (in that order) before performing Take Signal.

The calculations for the various data types assume the following definitions:

- **Signal:** uncorrected raw data acquired via **Take Signal**. “Signal”, as used in the definitions of the calculations, refers to “**raw**” data from the CCD and should not be confused with the possibly “**processed**” data to be found under the **Sig** tab of the Data Window.
- **Background:** data in uncorrected Counts, acquired in darkness, via **Take Background**.
- **Reference:** background corrected data, acquired via **Take Reference**.

For some spectrographs, it may be necessary to change the direction in which data is read out. Simply click the **Horizontally** tick box in the **Flip** section of the **FVB** tab as shown:

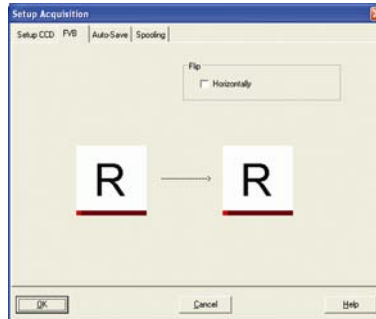

An example of flipped spectra is shown here:

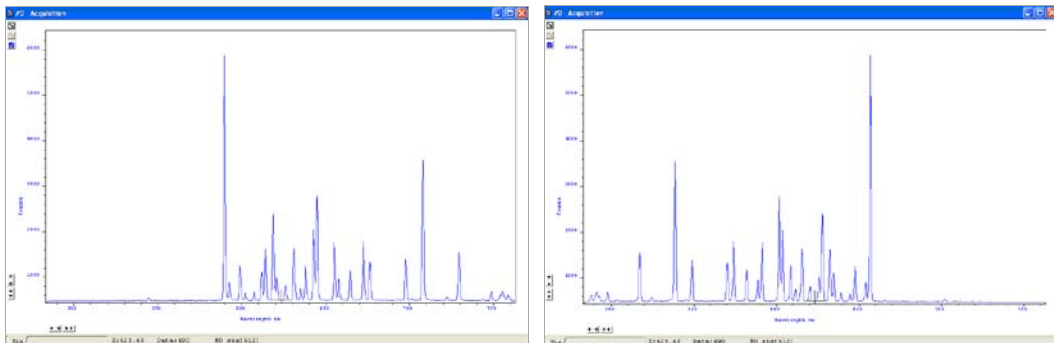

5.4 - ACQUISITION TYPES

From the Acquisition drop-down menu on the Main Window, you can make the following data acquisition selections:

- **Take Signal (see page 40)**
- **Take Background**
- **Take Reference**

Provided you do not change the acquisition parameters, the scans you take for background and reference are automatically used for subsequent data acquisitions whenever you perform Take Signal.

5.4.1 - Autoscale Acquisition

Prior to the **Take Signal** function being activated, **Autoscale Acquisition** can be selected from the Acquisition drop-down menu as shown (alternatively, press **F6** on the keyboard):

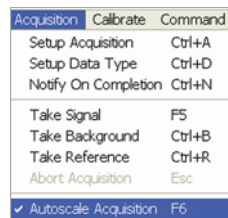

With Autoscale Acquisition deselected, the display will remain the same size regardless of brightness settings, etc. When selected off, the  button appears (click this button to switch back on).

With Autoscale Acquisition selected, the system will configure the Acquisition Window (if necessary adjusting its scales in real time) so that all data values are displayed as they are acquired. The  button appears when selected on. The data are displayed in accordance with the selection made on the Rescale Data Mode on the Display Menu:

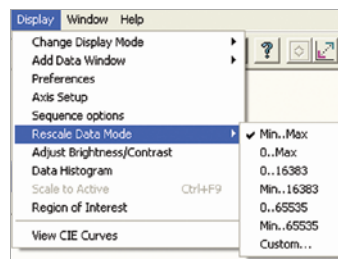

You can choose to display values between the following parameters:

- **Minimum & maximum (Min..Max)**
- **Zero & maximum (0..Max)**
- **Zero & 16383 (0..16383)**
- **Minimum & 16383 (Min..16383)**
- **Zero & 65535 (0..65535)**
- **Minimum & 65535 (Min..65535)**
- **Custom setting as required.**

For further information on **Rescale**, please refer to **page 77**.

5.4.2 - Take Background

The Take Background option of the Acquisition drop-down menu instructs the system to acquire raw background data.

These are as counts of the Acquisition Window. No calculations are performed on these data.

The data type you select via Setup Data Type on the Acquisition Menu may require you to perform Take Background before you perform Take Signal.

NOTE: You do not necessarily have to take background data prior to each acquisition of signal data. If the data acquisition parameters remain unchanged since you last performed Take Background, then no new background data are required.

5.4.3 - Take Reference

The Take Reference option of the Acquisition drop-down menu instructs the system to acquire background corrected data that will be used subsequently in calculations that require a reference value. Before executing this function you must therefore perform a Take Background.

The data you acquire using Take Reference are displayed as counts minus background under the Ref tab of the Acquisition Window.

NOTE: The data type you select via Setup Data Type on the Acquisition menu may require you to perform Take Reference before you perform Take Signal.

5.4.4 - Acquisition Errors

If you perform an operation “out of sequence”, the system will prompt you by launching an Acquisition Error message, e.g.

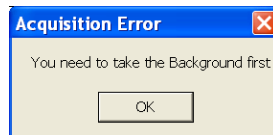

5.5 - ACQUISITION MODES & TIMINGS

An acquisition is taken to be the complete data capture process that is executed whenever you select Take Signal, Take Background, or Take Reference from the Acquisition Menu or whenever you click the Take Signal button. By contrast, a scan (an “**Acquired Scan**” in the definitions that follow) is 1x readout of data from the PDA-chip. Several scans may be involved in a complete data acquisition.

The minimum time required for an acquisition is dependent on a number of factors, including the Exposure Time (the time in seconds during which the PDA collects light prior to readout.) and the Triggering mode. Triggering modes are described in more detail later in this section.

5.5.1 - Single Scan

Single scan is the simplest acquisition mode, in which the system performs one scan of the PDA.

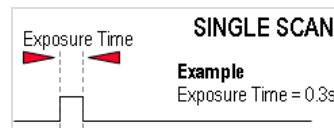

NOTE: Should you attempt to enter too low a value, the system will default to a minimum exposure time.

5.5.2 - Real Time

If you click the  button, the system repeatedly performs a single scan and updates the data display.

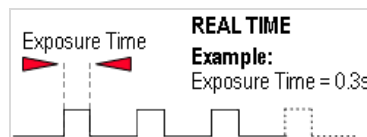

New data will continue to be acquired and displayed until you either :

- Select **Abort Acquisition** from the Acquisition Menu.
- Click the  button
- Press the <ESC> key.

This stops any data capture process that may be under way. **NOTE: This is a useful mode if, for example, you want to capture data as you optimize a hardware set-up.**

Accumulate mode allows you to add together in computer memory the data from a number of scans to create an 'Accumulated Scan' i.e.

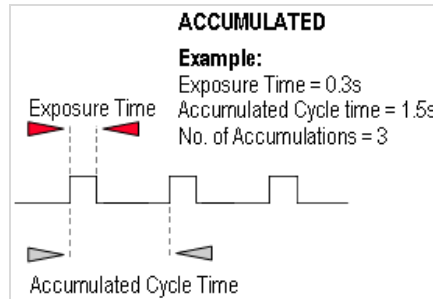

You can select the following parameters in the Setup Acquisition dialog box:

- **Exposure Time**
- **Accumulated Cycle Time:** the period in seconds between each scan. This parameter is only available if you have selected Internal triggering (please refer to **Triggering Modes** on **page 51**)
- **No. of Accumulations:** the number of scans you want to add together.

NOTE: This mode is used to improve the **Signal to Noise ratio**.

5.5.4 - Kinetic Series & Accumulated Kinetic Series

In the Setup Acquisition dialog box you can key in the following parameters, which relate both to the kinetic series itself (and where marked *, to the accumulation process):

- **Exposure Time**
- **Accumulate Cycle Time***: the period in seconds between the individual scans (see Number of Accumulations below) that are accumulated in computer memory to create each member of your kinetic series - each member of the series is an 'accumulated scan'. This parameter is only available if you have selected Internal Triggering.
- **Number of Accumulations***: the number of scans you want to add together to create each member of your kinetic series. The default value of 1 means that each member of the kinetic series will consist of a single scan.
- **Kinetic Cycle Time**: the interval at which each scan (or set of accumulated scans) begins. This parameter is only available if you have selected Internal Triggering.
- **Number in Kinetic Series**: the number of scans or accumulated scans you require in your series.

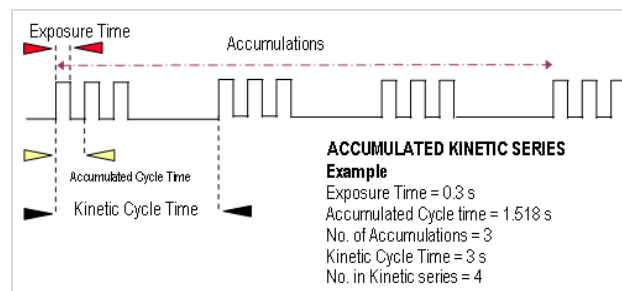
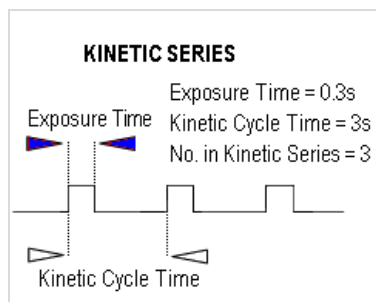

NOTE: This mode is particularly well suited to recording the temporal evolution of a process.

5.6 - TRIGGERING MODES

Triggering modes are selected from a drop-down list on the Setup Acquisition dialog box:

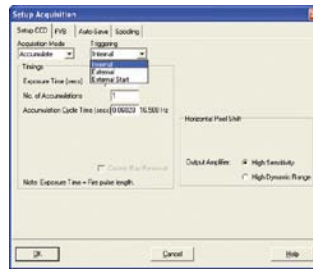

- **Internal**
- **External**
- **External Start (Accumulate or Kinetic Acquisition modes only)**

5.6.1 - Internal

In Internal mode, once you issue a data acquisition command, the system determines when data acquisition begins. You can use Internal mode when you are able to send a trigger signal or 'Fire Pulse' to a short-duration, pulsed source (e.g. a laser). In this case starting data acquisition also signals the pulsed source to fire. The Fire Pulse is fed from the **Fire** SMB connector on the detector. Internal Trigger Mode is also used with "Continuous Wave" (**CW**) sources (an ordinary room light, for instance), where incoming data, for the purposes of your observation, are steady and unbroken. This means that acquisitions can be taken at will.

IMPORTANT NOTES ON EXTERNAL TRIGGER FUNCTIONS:

1. **If you have a shutter connected and are using external triggering, you must ensure that the shutter is open before the optical signal you want to measure occurs.**
2. **The PDA sensor becomes responsive to signals between 2.8µs and 3.0µs after receipt of an external trigger. This active period is indicated by the pulse available from the Fire SMB on the rear of the camera.**

5.6.2 - External

In External mode, once you issue a data acquisition command, data will not be acquired until your system has received an External Trigger signal generated by an external device (e.g. a laser). The External Triggering signal is fed to the **Ext Trig** SMB connector on the rear of the detector. On receipt of an external trigger pulse, the camera will be fully responsive to light (indicated by a high Fire pulse output) between 2.8µS and 3.0µS later.

5.6.3 - External Start

With External Start triggering, once you issue a data acquisition command, data will not be acquired until your system has received an external trigger signal generated by an external device. The system will then continue to acquire data based on user options set within the Acquisition Dialog. This means that an External Start Trigger could be used to commence acquisition of a Kinetic series, but with the parameters of that series being controlled by internal software options. The External Start trigger signal is fed to the camera head via the Ext Trig SMB on the back of the camera.

5.7 - TRIGGERING TYPE SELECTION

The following flowchart will help you decide whether you should use Internal, External, or External Start triggering:

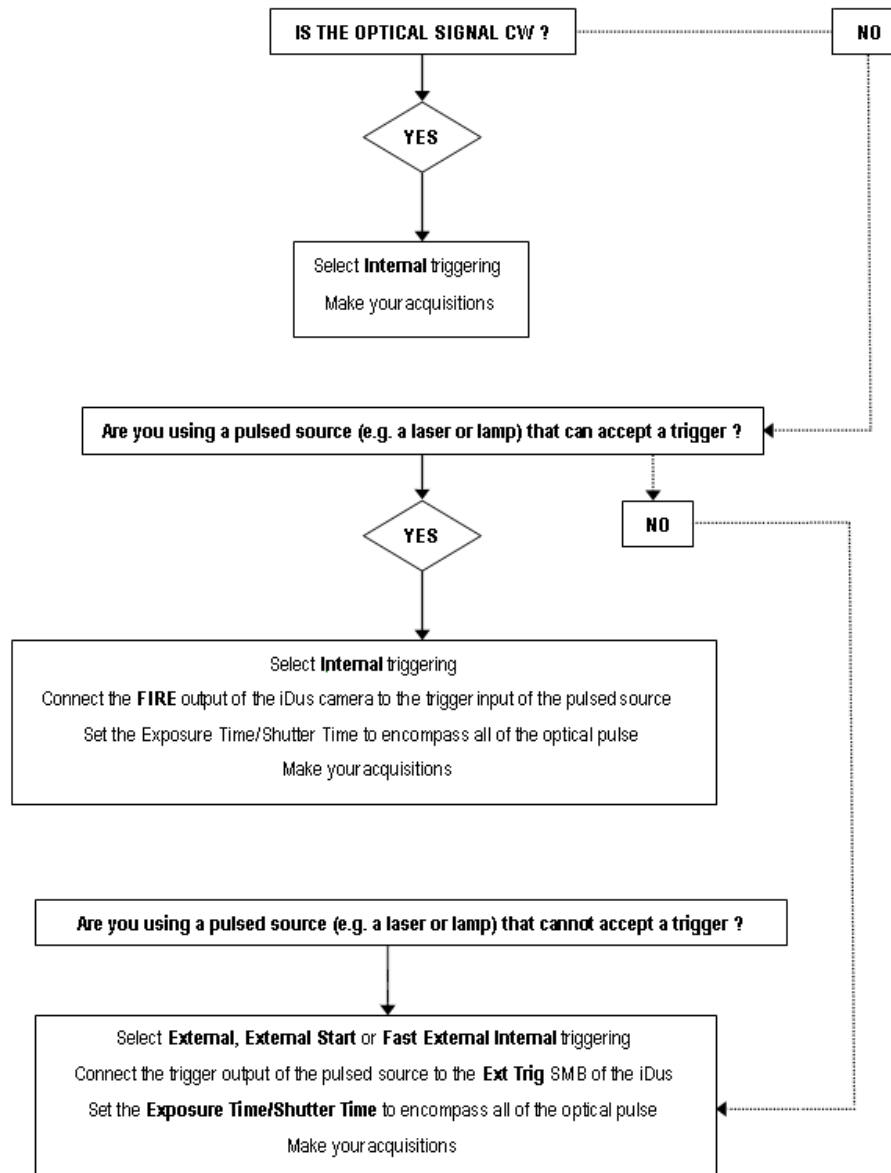

Depending on which combination of Acquisition, Readout & Triggering modes is selected, various timing parameters are available as follow:

- **Exposure Time (secs)**
- **No. of Accumulations**
- **Accumulation Cycle Time (secs)**
- **Kinetic Series Length**
- **Kinetic Cycle Time (secs)**
- **Cosmic Ray Removal**

When the **Shutter Control** option is selected from the **Hardware** drop-down-menu, or the  button is **clicked**, the **Shutter Control** dialog box opens e.g.:

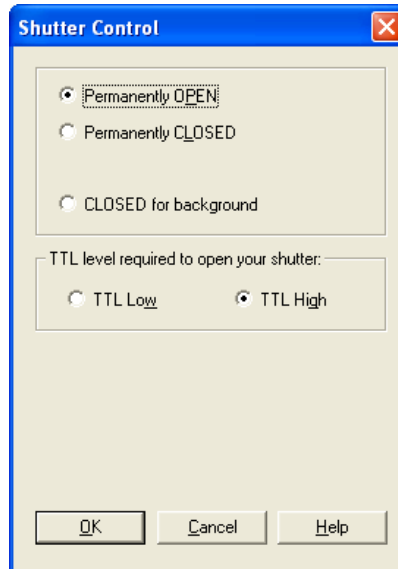

You can use this to indicate when and how a hardware shutter should be used. With a PDA, the shutter is used for background shuttering.

- In **Permanently OPEN mode**, the shutter will be open before, during and after any data acquisition.
- **Permanently CLOSED** mode can be useful if you want to take a series of acquisitions in darkness and do not require the shutter to open between acquisitions. You might, for example, wish to capture a sequence of background values. The shutter remains closed before, during and after any data acquisition.
- If **CLOSED for background** mode is selected, any shutter driven from the shutter output will be closed as you perform Take Background. If you want the shutter to be open so that the Take Background function records genuine optical background data, deselect the option.

NOTES:

1. **Certain settings (e.g. Permanently OPEN & Permanently CLOSED) take effect as soon as you close the Shutter Control dialog box. Other settings will be applied whenever you acquire data.**
2. **Usually a background scan is used to subtract the dark signal and the Fixed Pattern Noise (FPN) of the sensor. For this reason the background scan is usually performed in darkness. A shutter may be used to stop light entering the spectrograph or other imaging system. Strictly speaking though, the background acquisition may be regarded as comprising all light with the single exception of the source. Thus, when you are working with a pulsed or independently shuttered source, it may be appropriate to have the mode deselected.**

- The **TTL** (Transistor-Transistor logic) buttons, **TTL Low** & **TTL High**, let you instruct the system as to how it should control the opening and closing of the shutter.
 - If you select **TTL Low**, the system will cause the output voltage from the iDus to go 'low' to open the shutter.
 - If you select **TTL High**, the system will cause the output voltage from the iDus to go 'high' to open the shutter.

The documentation supplied by the shutter manufacturer will show whether your shutter opens at a high or a low TTL level. An illustration of the TTL structure is shown below. **NOTE: The shutter pulse is not capable of driving a shutter. It is only a 5V pulse designed to trigger TTL & CMOS compatible shutter drivers. Also there is no shutter pulse during the Take Signal and Take Reference data acquisitions.**

TTL & CMOS COMPATIBLE

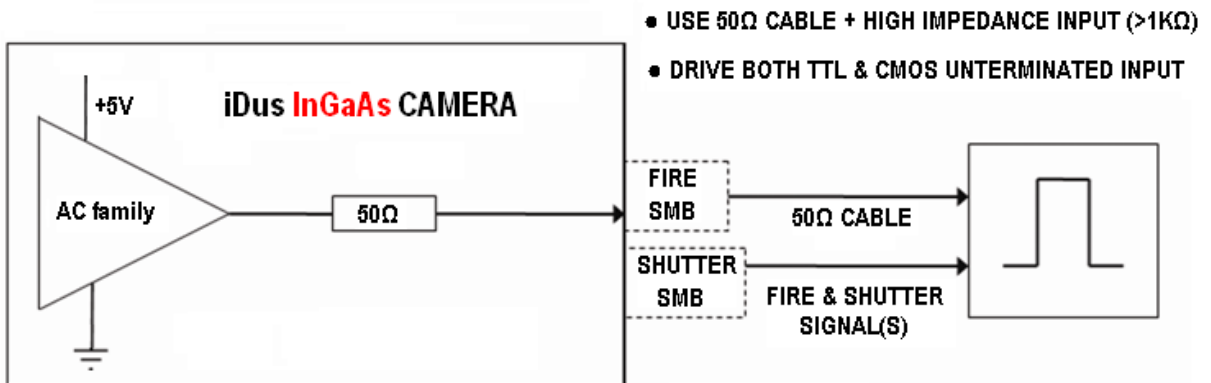
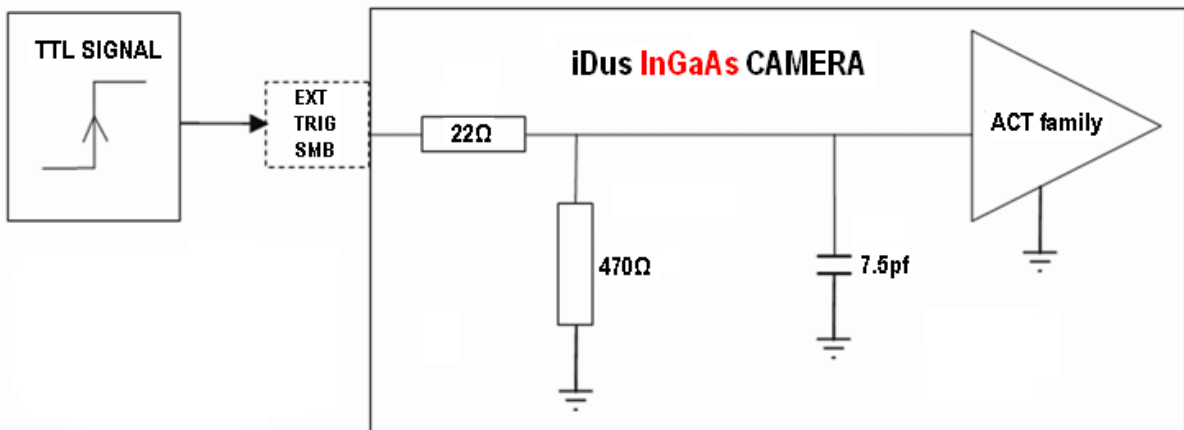

5.9.1 - Time to open or close

Shutters take a finite time to open or close and this is sometimes called the **Shutter Transfer Time (STT)**. The documentation supplied by the shutter manufacturer should indicate the STT you can expect from your particular shutter. In the case of a PDA detector, the STT gives enough time for the shutter to open before acquisition starts and enough time to close after acquisition finishes and before readout commences.

Let us look at the Transfer Time in the context of the Andor system. By default, the value you enter in the Exposure Time text box on the Setup Acquisition dialog box determines the length of time the shutter will be in the open state.

However, to accommodate the Transfer Time, the rising edge of the shutter output is sent before the **Fire** output signal by an amount equal to the STT. You should set this value to the Transfer Time of your shutter.

The system also automatically adds the Transfer Time to the end of the acquisition sequence, introducing an appropriate delay between the start of the shutter closed state and the commencement of the data being read out as shown in the following example diagram:

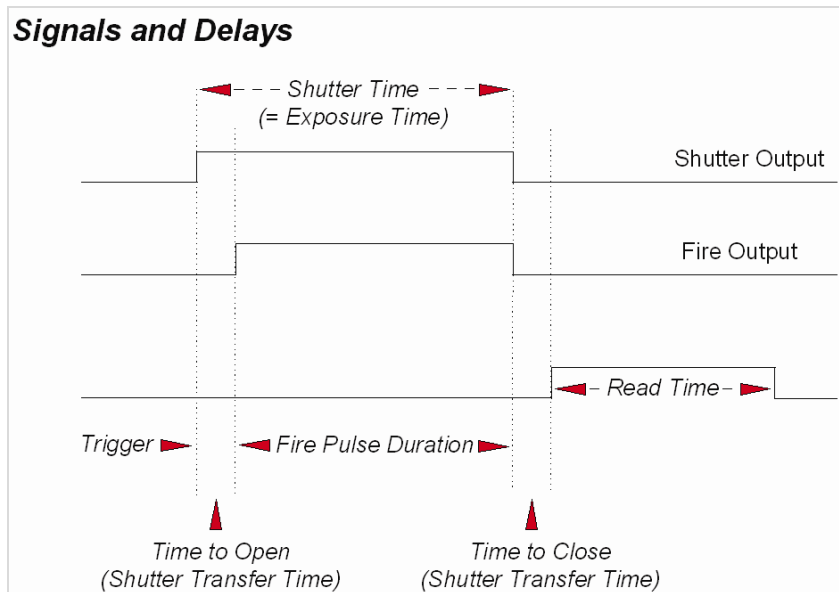

If you do not have a shutter connected, set the Time to open or close to 0. Setting the Time to open or close to any other value will insert extra delays into cycle time calculations.

5.9.2 - Exposure Time

As mentioned previously, **Exposure Time (secs)** is the time during which the PDA collects light prior to readout. The system will default to a minimum exposure time should you attempt to enter too low a value.

5.9.3 - Accumulate Cycle Time & No. of Accumulations

If you have selected Accumulate or Kinetic as the acquisition mode, with Internal triggering, you can also select the Accumulation Cycle Time and No. of Accumulations.

The Accumulation Cycle Time is the period in seconds between each of a number of scans, whose data are to be added together in computer memory to form an Accumulated Scan.

The Number of Accumulations indicates the number of scans you want to add together.

5.9.4 - Kinetic Series Length & Kinetic Cycle time

When Kinetic is selected as the acquisition mode, with Internal triggering you can also select the Kinetic Series Length and Kinetic Cycle Length (secs).

- The Kinetic Series Length is the number of scans you require in your series.
- The Kinetic Cycle Length is the interval (in seconds) at which each scan (or accumulated scan) in your series begins.

5.10 - COSMIC RAYS

Cosmic rays are very high energy particles, originating in outer space, that enter the Earth's atmosphere and produce a shower of further high energy particles. When one of these particles passes through the PDA it will produce between 0 and thousands of photoelectrons in a very small area (usually 1 to 4 pixels) and due to the low read noise of the PDA this will appear as a spike of up to several hundred counts.

If the Cosmic Ray Removal option is selected, each scan will be compared with the previous one, for the presence of unusual features. An example of a unusual feature is shown here:

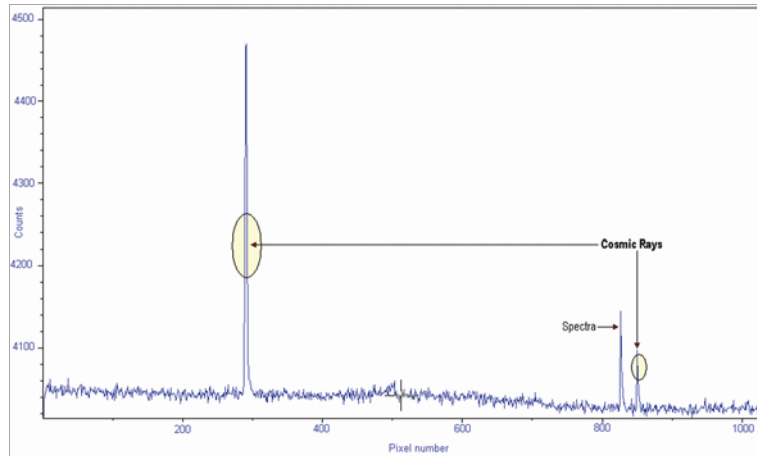

If one is found, its pixel value will be replaced with a scaled version of the corresponding scan, e.g.:

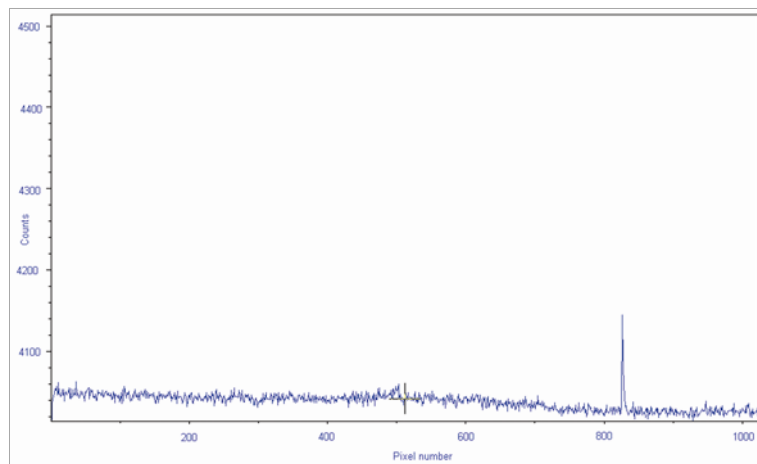

NOTE: This option is only available if there are 2 or more scans to compare. It takes twice as long to acquire one data set.

5.11 - GAIN & NOISE VARIATIONS

On the InGaAs sensor, there is an amplifier for each pixel. In the case of the DU492 the pixels are 50 μm wide and these amps can all be located on the same side of the pixels. For the DU490 and DU491 the pixels are 25 μm wide and there is not enough space to fit the pixel amps on the same side - therefore they are located alternatively above and below the pixels.

This gives rise to a slight difference between the Base Mean Levels (BML) of the odd and even pixels. The pixel amps are laid down on one side and then the other, and therefore there may be a slight trend in the response uniformity and noise along the odd pixels, and along the even pixels; these trends may not be in the same direction.

Due to these effects it is always recommended that a 'flatfielding' or, at the least, a background correction, is performed whenever possible with InGaAs cameras.

Details of the Acquisition selection can be viewed by clicking the  button on the Main Window which opens the **Information** dialog box (you can also enter your own notes in the Comments area):

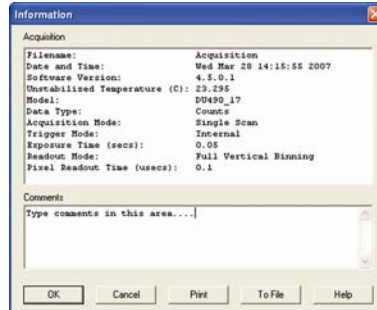

The table below details the type of information contained in the dialog box.

Table 8: Information Types

Filename	The filename associated with the active Data Window. If the data has not yet been saved this will default to Acquisition
Date and time	The date & time at which the acquisition was made
Software Version	The version of Solis software in use
Unstabilized Temperature (C)	The temperature to which the detector had been cooled
Model	The model number of the detector
Data Type	Data Type: Counts, % Transmittance, etc.
Acquisition Mode	Single Scan, Accumulate or Kinetic
Trigger Mode	Internal, External or Fast External
Exposure Time (secs)	'Fire' pulse length
Delay (secs)	Value in microseconds
Pixel Readout Time (usecs)	Value in microseconds

SECTION 6 - DISPLAYING DATA

6.1 - DISPLAY MODES

Once the parameters for the data acquisition have been set and data has been successfully acquired, there are three main options available to display the data, which are as follows:

- 2D
- 3D

The Display drop-down menu also offers various options to change the various formats of the display as shown:

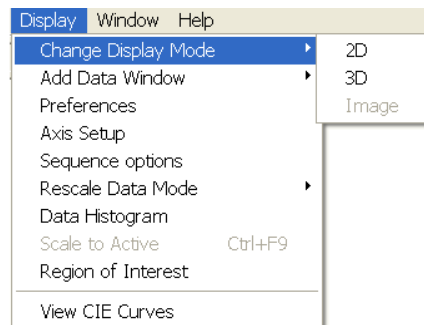

Some of the options are also available via icons on the Main Window and these are shown later in this section.

NOTE: The menu item Scale to Active is only available if you are in 2D display mode and have chosen to overlay a number of traces. This is explained in more detail in Overlay on pages 70 - 74.

6.2 - DISPLAY PREFERENCES

The way data is displayed in the various modes can also be changed. From the Display menu drop-down options, select the Preferences option as shown:

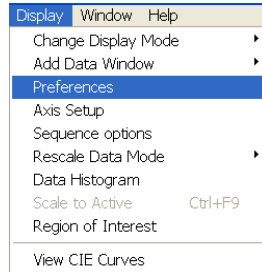

The Display Preferences dialog box appears as shown:

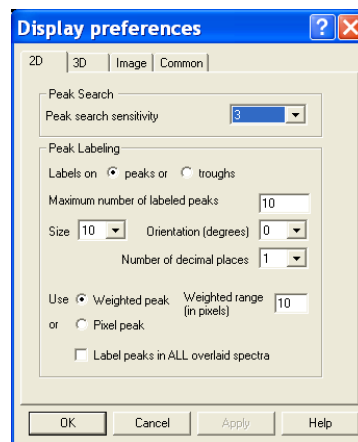

By clicking on the appropriate tab, you can select or deselect certain features associated with the data window for the mode of your choice.

When you are in 2D or 3D display mode and the Axis Setup option on the Display menu is selected, the Axis Setup dialog box opens as shown:

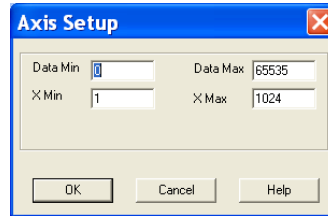

The minimum & maximum values you wish to appear on the x- and data-axes (the horizontal and vertical display axes respectively) of your data window can be entered in the text boxes.

If you select Axis Setup while you are viewing data in Image display Mode, the Axis Setup dialog box opens as shown:

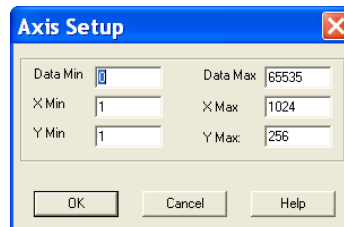

You can now also enter, in the text boxes, minimum & maximum values for the y-axis (the vertical display axis) of your data window. In a full resolution image, data are represented as a color or a grayscale tone.

You can now enter minimum & maximum x- and y- values of your choice, provided those values (when converted to pixels) do not exceed the width or height of the PDA sensor.

However, if you have selected Always Maintain Aspect Ratio in Preferences, the system may have to resize the 'plotting region' in which the image appears: the plotting region then generally occupies less of the available window space, but the aspect ratio is maintained.

NOTE: If you want the system to use the maximum available window space, either resize the data window or click the Reset button.

In 2D display mode, you can also zoom into an area by drawing a Zoom Box. In both instances, hold down the primary mouse button and pull the cursor in a diagonal across the screen around the area that you are interested in, e.g.:

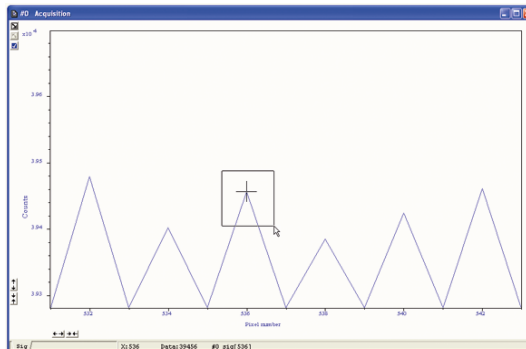

- In 2D mode, the top and bottom edges of the zoom box demarcate the range of values that will be shown over the full height of the data-axis. Having drawn the zoom box, release the mouse button to perform the zoom operation. The minimum zoom width is 30 pixels.

NOTE: You may wish to perform a Rescale (see page 76) on data you have just zoomed. Rescale will plot all recorded data values that fall within the new, zoomed range of the x-axis against a newly calibrated data-axis. In this way you will be able to see peaks and troughs that may have been clipped off by your zoom box.

- If you have selected **Always Maintain Aspect Ratio** you may find that an area slightly larger than the zoom box has been expanded. The system adds extra area as necessary so that the zoomed image accurately represents the height to width ratio of the individual pixels on your PDA-sensor.



NOTE: To help the system zoom the area you require, draw the zoom box in similar proportions to the height and width of the image display.

6.5 - ZOOMING & SCROLLING

The following functions are available in data windows whilst in 2D & 3D Display modes:

- Zoom in
- Zoom out
- Scroll

6.5.1 - Zoom In & Zoom Out

On a data window in 2D or 3D display mode, pairs of Zoom In:  and Zoom Out:  buttons are provided on both the x- and data-axes of the trace. These buttons allow you to stretch or shrink the scale (to cover a smaller or larger range) on either the x- or data-axis, creating the effect of zooming in or zooming out in either the vertical or horizontal dimension of the display.

6.5.2 - Scrolling

If you have stretched a scale by zooming, you can slide the scale to cover a different range and the display will scroll in synchronization with the moving scale. Place the cursor arrow over the scale so that it changes to a finger flanked by arrows. Now depressing the primary mouse button allows you to 'slide' the scale up and down (or left and right) and scroll the display.

If you place the finger cursor at either end of an axis you will notice that a single arrow appears beside it, indicating the direction in which the scale will slide automatically when you depress the primary mouse button: the display "fast scrolls" accordingly.

6.5.3 - Reset

Clicking the  button when a Data Window is open, returns the displayed data to its original configuration, thus undoing any adjustment to scale that you may have performed in accordance with the descriptions given in Zooming In, Zooming Out, Scrolling and **Rescale** (see page 77). Reset is available for all display modes.

6.6 - 2D DISPLAY MODE

To view data in 2D, either select 2D from the drop-down menu or click on the  button. Data is then displayed as an unlabeled trace, e.g.:

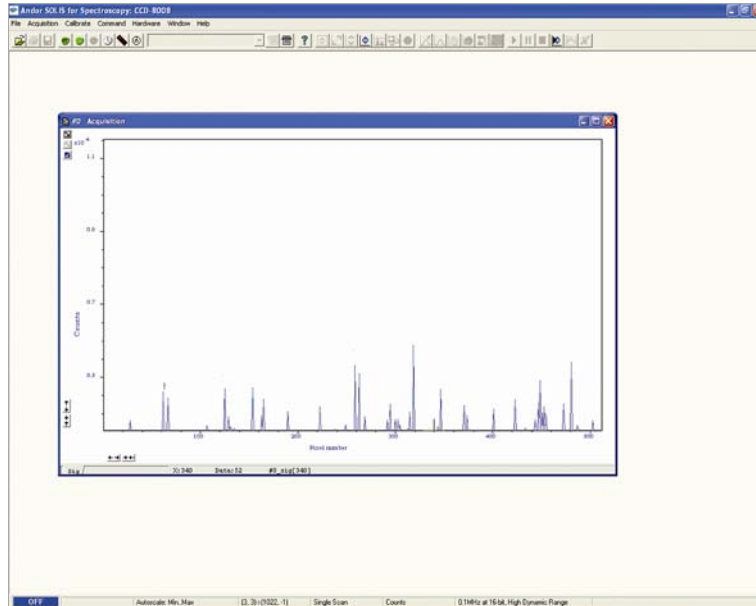

6.6.1 - 2D display mode preferences

The following options are available to view peaks when in 2D Display mode:

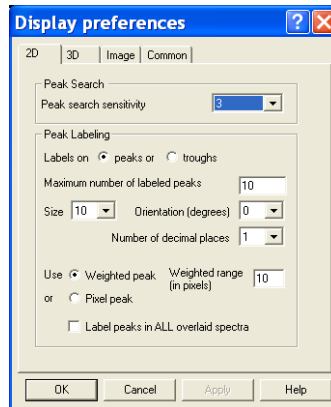

The display is similar to the following:

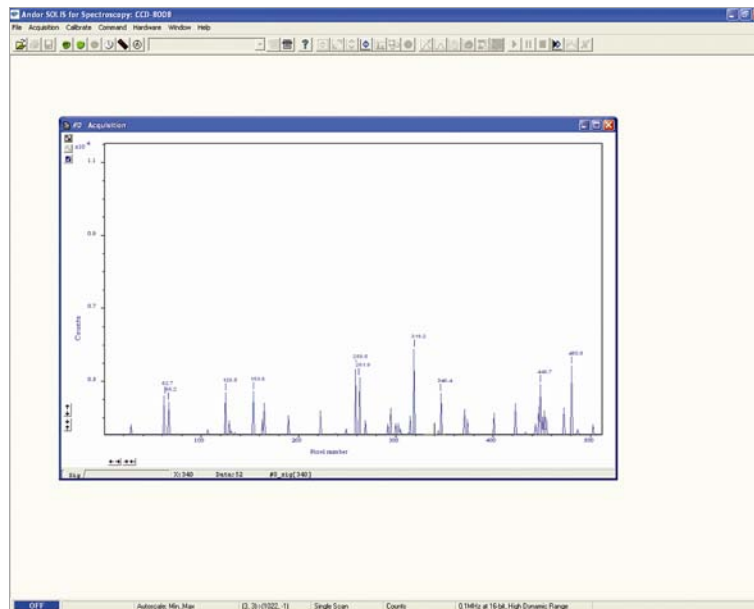

6.6.1.1 - Peak Search

6.6.1.1.1- Peak Search Sensitivity

The Peak Search Sensitivity option Determines the manner in which the cursor moves between peaks/troughs when you key in Ctrl + Right Arrow or Ctrl + Left Arrow.

A low sensitivity (e.g. 1) means the system will find the most prominent peaks or troughs.

A high sensitivity (e.g. 5) means less obvious peaks or troughs will be found.

NOTE: This parameter relates only to Peak Search, not to Peak Labeling.

6.6.1.2 - Peak Labeling

6.6.1.2.1 - Labels on Peaks or Troughs

Lets you choose whether to mark the highest points (peaks) or lowest points (troughs) on the trace.

6.6.1.2.2 - Maximum Number of Labeled Peaks

Causes only the highest peaks or lowest troughs, up to the total number of peaks/troughs indicated, to be labeled automatically.

6.6.1.2.3 - Format Labels

- **Size, Orientation & Number of Decimal Places** lets you format the peak labels
- For **Orientation**, 0° is horizontal; 90° is vertical
- You can have up to 4 decimal places in the label

6.6.1.2.4 - Weighted Peak

Weighted Peak in combination with a Weighted Range (centered on the highest/lowest positioned pixel) lets the system calculate and label a weighted mean to represent the peak or trough.

NOTE: This feature works best on peaks or troughs which are symmetrical about the highest/lowest point.

6.6.1.2.5 - Pixel Peak

The system can label the Pixel Peak (the highest/lowest positioned pixel).

6.6.1.2.6 - Label Peaks in all Overlaid Spectra

You can also choose whether to Label peaks in all overlaid spectra or to have peaks labeled only on the active trace. Please see **pages 70 - 74** for further information on overlaying data.

To label peaks automatically, either select 2D from the drop-down menu or click the  button. The data window display will change e.g. :

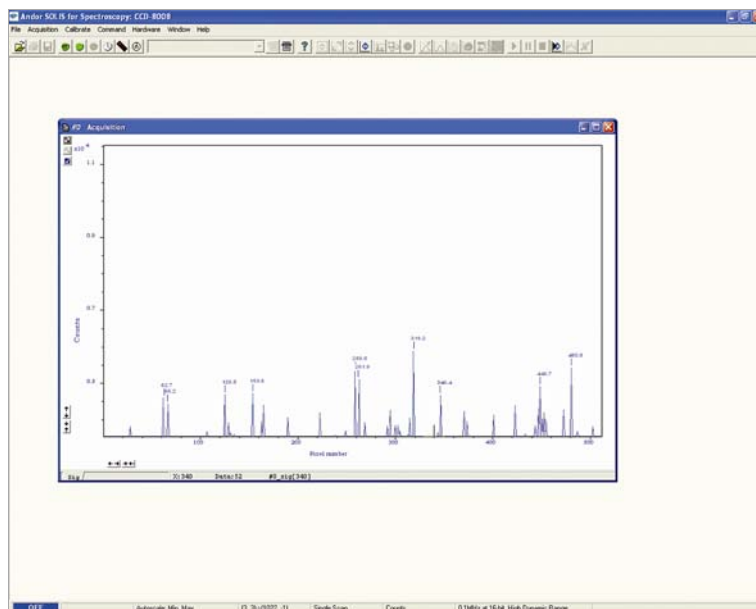

When labeling is selected, you can label a peak manually by double clicking it. To remove a peak label, double click it again. If you switch off peak labeling (by clicking the  button) your manual labeling will be lost. **NOTE: To manually label peaks accurately it is best to zoom in on the trace as described previously.**

By default, the x-axis will be calibrated in pixels (1 on the x-axis corresponds to the position of the first column of pixels on the PDA-chip, etc.). The data-axis will by default be calibrated in counts. For details of how to change the calibration on the x-axis, please refer to **Section 8**.

If you have acquired data in an imaging mode you will be able to view the data from each track on the PDA-chip (or row if you have acquired a Full Resolution image).

To view the traces from each track or row individually, use the scroll bar on the data window. The numeric display on the bottom edge of the data window will indicate which track or row you are currently viewing. **NOTE: If there is only one track of data, no track or row number will be displayed, nor will there be a scroll bar.**

If you have acquired data as a Kinetic Series, you may also use the scroll bar to move between the members of the series. The display on the bottom edge of the data window will indicate which member of the series you are currently viewing.

To read off a data value, click on the trace to position the cursor on the point of interest (you may need to use the left and right arrow keys on your keyboard to position the cursor precisely). The numeric display on the status bar along the bottom edge of the data window will indicate the corresponding x- and data-values.

The ability to **Overlay** data traces is useful if you wish to compare several traces on the same axes. You can display up to nine 2D traces simultaneously in the same data window. The data window in which you intend to display the overlaid traces must be in 2D display mode. Only the data which were originally in that data window can be saved or modified when the data window is active. You cannot, for instance, use the data window to calibrate traces that have been added as overlays. The data window from which the 2D overlays are taken can be in any display mode. **NOTE: The examples shown for Overlay functions are taken from an Andor Newton camera setup, but the principle is exactly the same**

- To add an overlay, first obtain a live signal, e.g.:

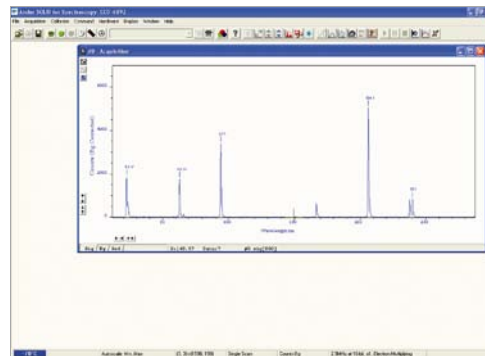

- Then save the image as a SIF file, e.g.:

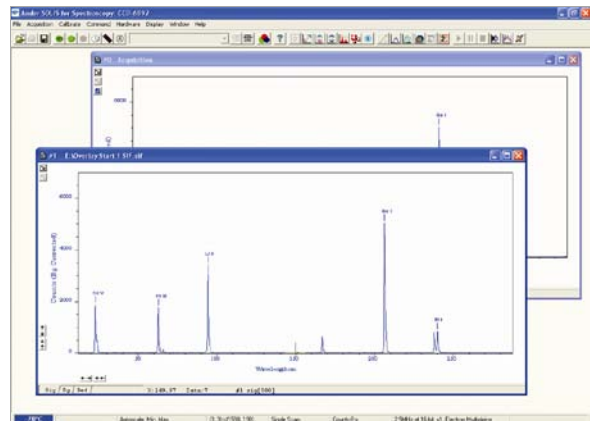
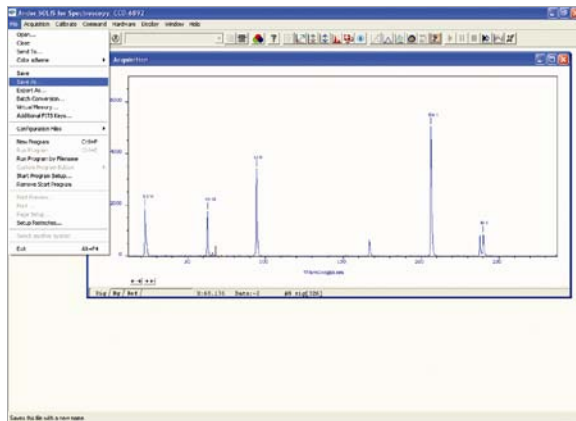

- Take some further acquisitions (this is normally done with different parameters set) and save these as SIF files again. The examples below show the same source as above but acquired in different modes:

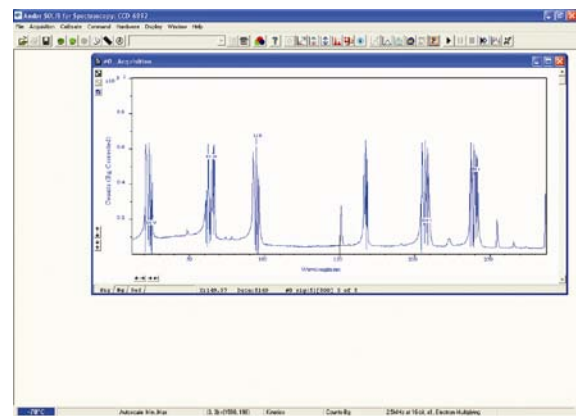
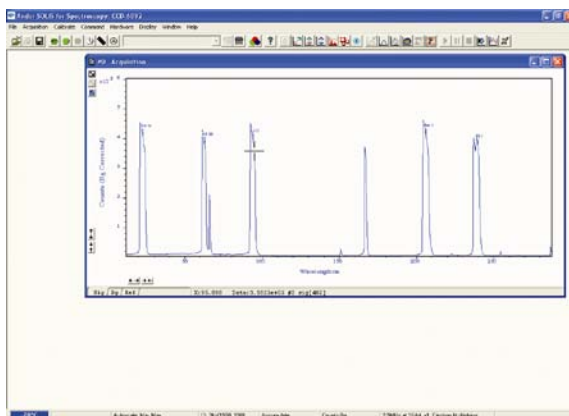

- When you have taken all the reference acquisitions required, keep the last live acquisition window active and open the previously saved SIF files.
- Click the  button on the live #0 Acquisition data window and the **Add Another Trace To Display** dialog box appears:

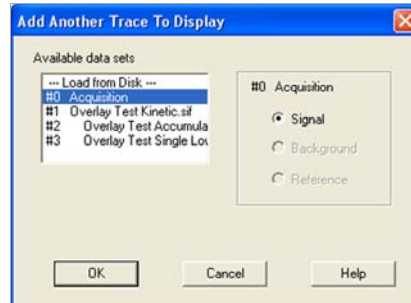

The selection list displays the names of data sets that are already being displayed in a data window. Alternatively you can select files previously stored by selecting the **Load from Disk** option and choosing the appropriate file or files, e.g.:

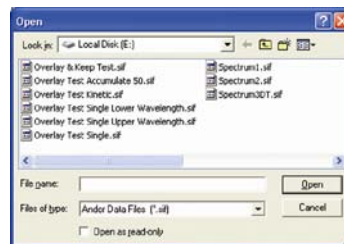

Buttons also let you specify **Signal**, **Background** or **Reference** data (if these are contained in the data set you have selected for overlay).

- Once you have selected the required file(s) and clicked **OK**, the display will change, e.g.:

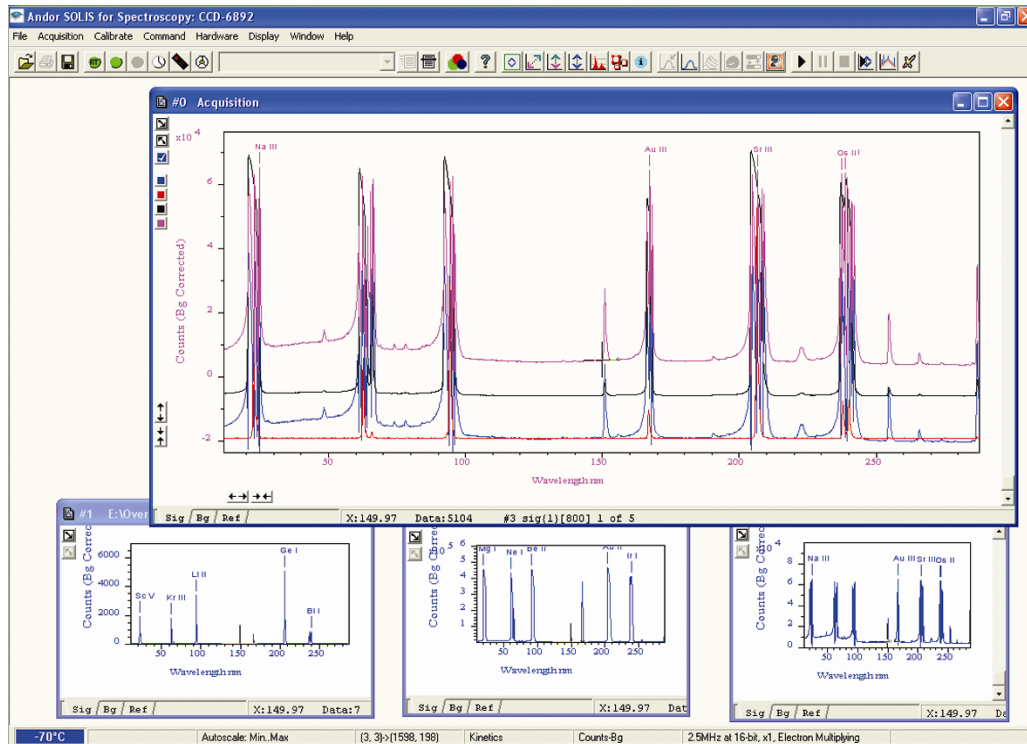

NOTE: You can add up to a maximum of 8 overlays to your original data trace.

The original data trace is always displayed in blue. Each new overlay appears in a unique identifying color and the **Active Trace** button is displayed on the left in the same color.

- To manipulate the trace you want, click on the Active Trace button corresponding to the color of the trace you wish to work with. The values on the horizontal and vertical axes will change to correspond to the Active Trace and will be presented in the same color as the trace itself.
- Once active, a trace can be manipulated the same manner as any **2D Display**. If you try to add too many traces, you will be prompted with the following message:

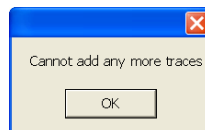

6.6.3.2 - Scale to Active

If you have overlaid a number of traces, the **Scale to Active** option becomes available on the **Display** Menu, e.g.:

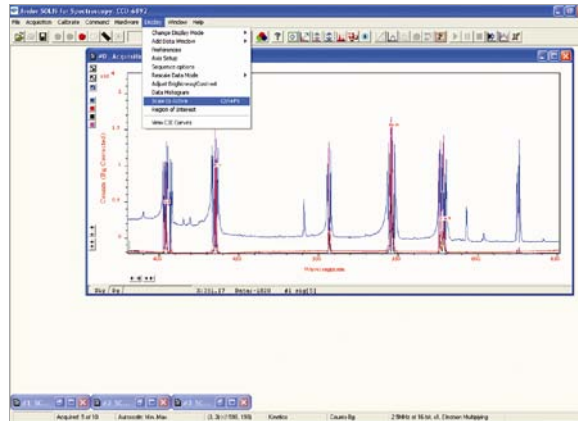

When Scale to Active is selected, all the data traces in your data window will be plotted against the scales of the active trace, e.g. for the red trace:

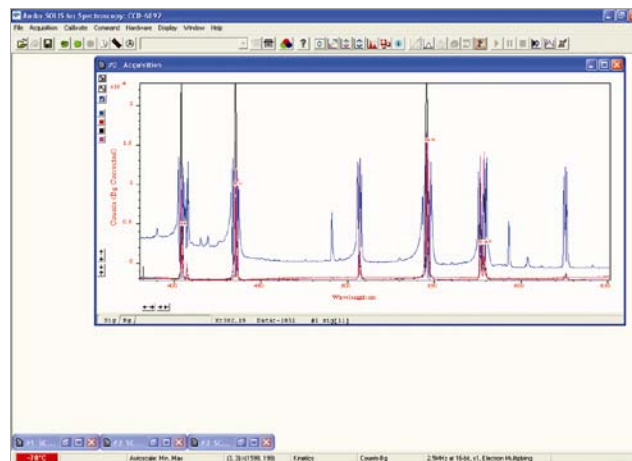

Vertical axes will be rescaled even if the units do not match those of the active trace.

6.6.3.3 - Remove Overlay

If you want to remove an overlay, first make sure that it is the Active Trace then click the  button.

If necessary use the Active Trace buttons to select a new active trace.

6.7 - 3D DISPLAY MODE

If you have acquired data in Imaging mode or as a Kinetic series you can view the traces taken from all the rows or tracks on one set of axes in a data window. Select the 3D option from the Change Display Mode option on the Display menu, or click the  button. A data window will appear e.g.:

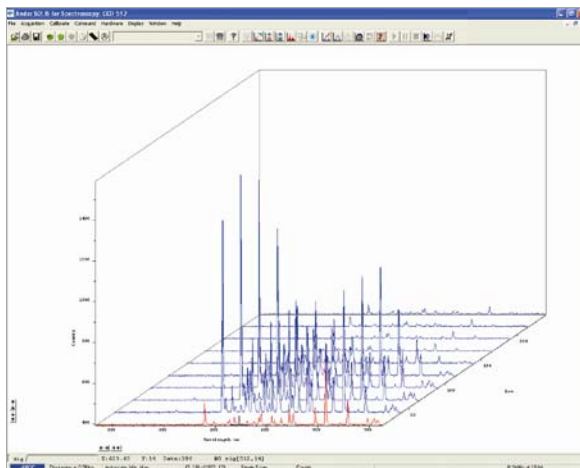

Along with the x-axis (calibrated by default to represent pixels across the PDA-sensor) and the data-axis (calibrated by default in counts), you now see a 3rd (or y-axis) calibrated in rows or tracks, depending on the acquisition mode you have selected.

To read off a data value on a particular trace, use the scroll bar on the data window to move the trace into the plane delineated by the x- and data-axes, and click on the trace to position the cursor on the point of interest (you may need to use the left and right arrow keys on your keyboard to position the cursor precisely).

The numeric display on the status bar along the bottom edge of the data window will indicate the series member on which the cursor is positioned ('Kinetics'), along with the corresponding x- and data-values.

If your data set contains a series of images (each of which may represent data acquired in Kinetics Mode) you will notice that the data window has two scroll bars, placed end to end. The upper scroll bar allows you to move between the members of the series, while the lower scroll bar allows you to view the traces that make up the particular member of the series.

NOTE: Zooming, Scrolling and Reset functions are the same as for 2D mode.

6.7.1 - 3D display mode Preferences

When 3D display mode is selected, the following options are available from the **Display preferences** dialog box:

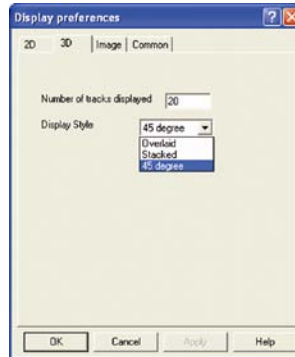

You can display multiple tracks either **Overlaid**:

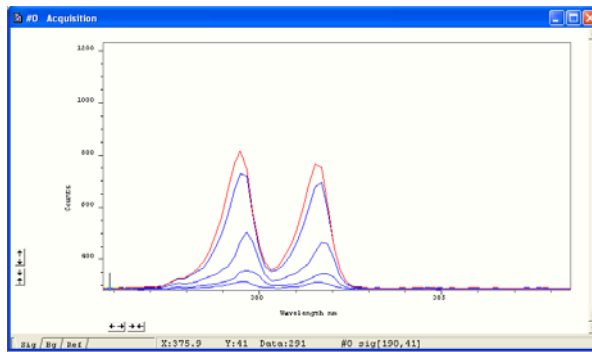

or **Stacked**:

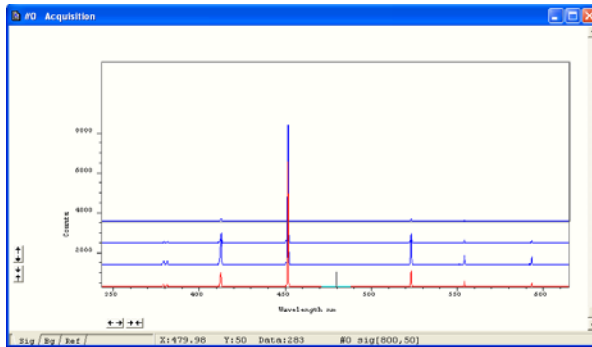

or at **45 degrees**:

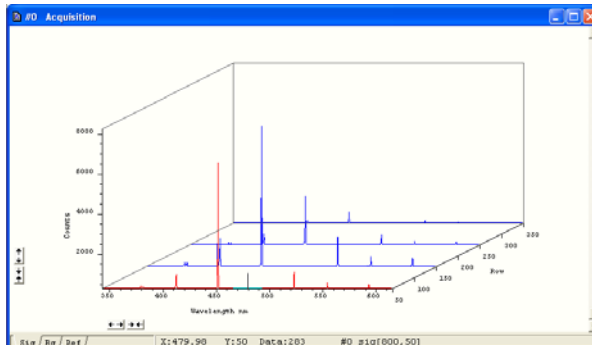

6.8 - RESCALE

When a data window is open and you click on the  button on the button bar of the Main Window, the system displays against an appropriate data scale all data that falls within the range selected on the x-axis. In Image Display Mode, it will also be displayed in appropriate colors or grayscale tones.

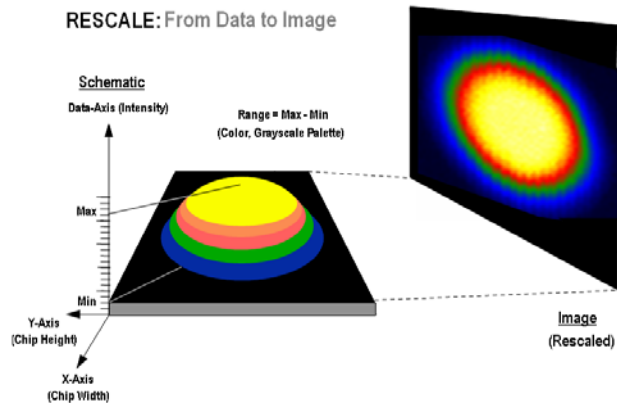

From the **Rescale Data Mode** menu of the **Display** drop-down menu, you can also select the maximum number of counts that can be recorded for a single pixel, your rescaled data distinguishes values between the following parameters:

- **Minimum & maximum (Min..Max)**
- **Zero & maximum (0..Max)**
- **Zero & 16383 (0..16383)**
- **Minimum & 16383 (Min..16383)**
- **Zero & 65535 (0..65535)**
- **Minimum & 65535 (Min..65535)**
- Custom Setting: When **Custom..** is selected, the **Custom Autoscale** dialog box appears, e.g.:

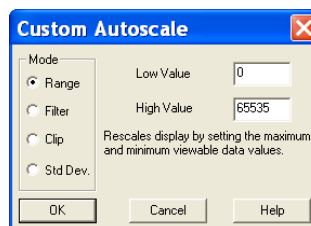

Autoscale Acquisition performs a similar function for the display of data as they are being acquired. It can be selected from the Acquisition drop-down menu, or by clicking the following buttons:

 = On

 = Off

F6 on the keyboard.

Rescale is available for all the Display Modes.

The Data Histogram dialog Box is launched either by clicking on the  icon on the Main Window, or selecting Data Histogram from the Display drop-down menu. This tool allows you to plot a histogram, or graph, between the maximum and minimum data points in the displayed range. It also contains a filter drop down menu, which allows for more accurate analysis and presentation of data values.

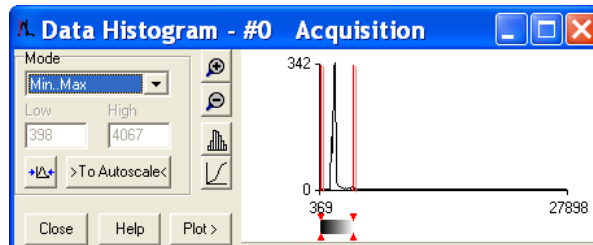



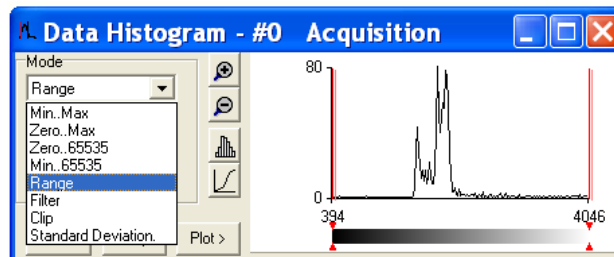

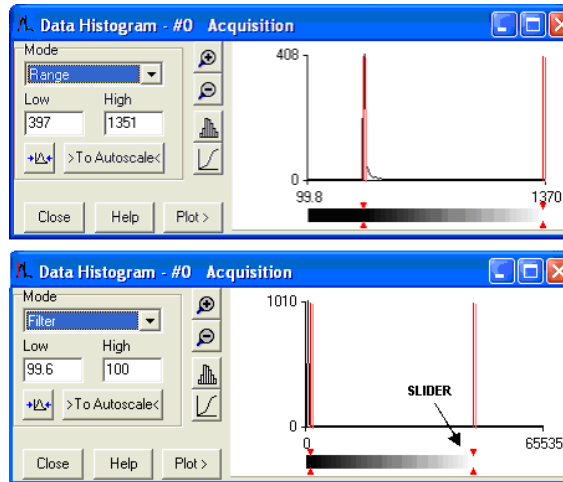

By clicking on an open data window, its histogram will be displayed on the Data Histogram dialog. When plotting the histogram, the focus is transferred to the new data window and the displayed histogram is that of the plotted histogram. The data from which the histogram is displayed is indicated on the title bar of the Data Histogram dialog. To return the focus on the original data, click on the original data window. Modes to view specific areas of spectra can be selected through the drop-down menu:

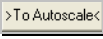

Values can be modified either by typing in the new values in the Low and High text boxes or by dragging the red arrows and bars below the histogram, e.g.:



- **Update:** Any change on the mode and/or the Low/High values is updated when the Update button  is clicked.
- **Autoscale:** After clicking the  button, acquisitions that follow will use these scaling settings as default.
- **Expand to bounds:** clicking on the  button zooms in on the histogram.
- **Zoom Out:** clicking on the  button zooms out on the histogram.
- **Bar Chart:** clicking on the  button toggles between x-y and bar chart histogram display.
- **Cumulative:** clicking on the  button toggles between cumulative (integral) and non-cumulative histogram display.
- **Plot:** clicking on the  button plots the histogram into a data window.

6.10 - REGION OF INTEREST

Region of Interest (ROI) is an important post-acquisition tool, used for quantitative analysis and it can be selected either by clicking the  button or selecting **Region of Interest** from the Display drop-down menu. When ROI is selected, the following dialog box opens:

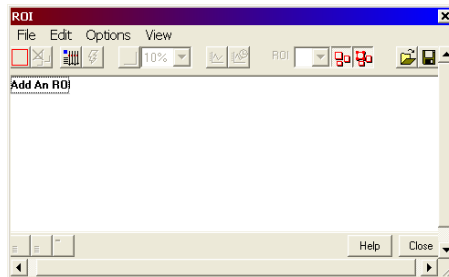

An ROI can be drawn on the image by positioning your cursor on the red ROI, and dragging out the using the corner handles.

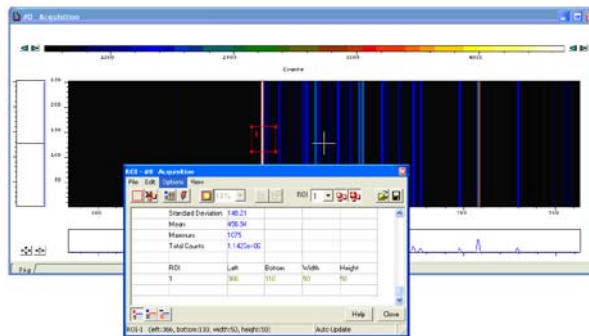

You can use this tool to select and draw multiple ROI's onto your image, then use the ROI data set to compare the values obtained, e.g.:

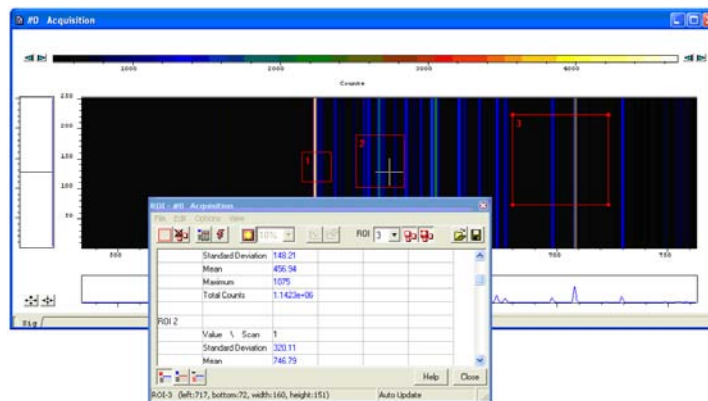

There are 3x buttons in the bottom-left of the ROI dialog box:

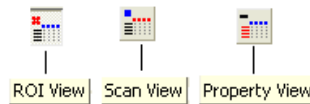

Clicking the View button will present and group your ROI data, according to each individual ROI region selected on the image. It will also display the pixel co-ordinates of all the ROI's for that scan, e.g.:

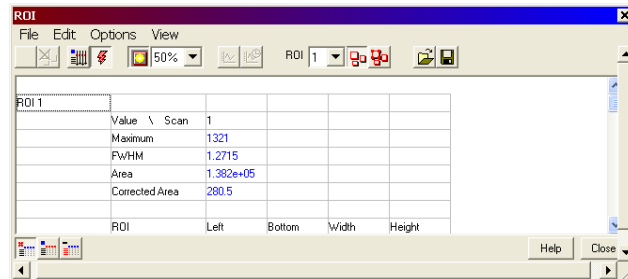

Clicking the Scan button will present and group your ROI data, according to individual data scans. It will also display the pixel co-ordinates for all the ROI's for that scan, e.g.:

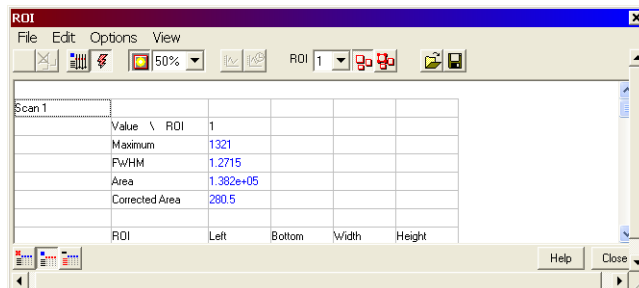

Clicking the Property View button will present and group your ROI data, according to value regions, i.e. Mean, Range and Standard Deviation. It will also display the pixel co-ordinates for all the ROI's for that scan, e.g.:

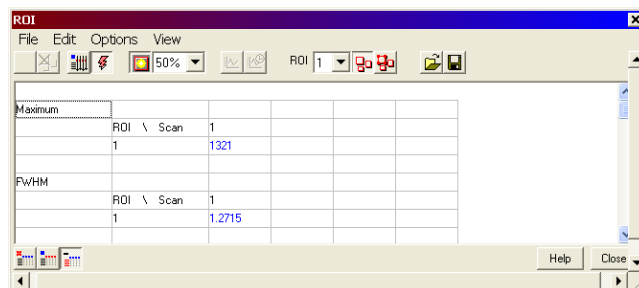

6.10.1 - ROI Counter



The ROI Counter identifies the current active ROI. It can also be used to select and isolate a particular ROI, which can be a useful tool, e.g. if two ROI's are overlapping or are layered on top of each other. By clicking the down arrow, you can also see how many ROI's are currently defined.

6.10.2 - Hot Spot Approximation

Hot Spot Approximation can be used to take a selected percentage of the highest data values within a given ROI.

To select, click on the  button, then select the % required from the drop-down menu. For example selecting 50% will give you the mean value for the top 50% of pixel values within the ROI.

6.10.3 - Recalculate

To recalculate the values in the ROI window, click on the  button.

6.10.4 - Live Update

You can receive and calculate ROI data, while the system is acquiring a Kinetic Series or running in Real Time Mode.

To select, click on the  button. The software is then able to acquire data and at the same time calculate and tabulate ROI data.

6.10.5 - Maximum Scans

When the Maximum Scans is selected from Options drop-down menu of the ROI dialog box, the Maximum Scans dialog appears, e.g.:

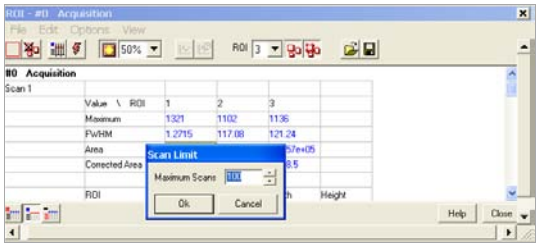

You can then enter the length of the history buffer you require (i.e. the number of previous values stored when acquiring in Real Time Mode with the Live Update feature enabled).

NOTE: This defaults to 100 and can be modified for longer series.

6.10.6 - Plot Series

Select any data value for a particular ROI and series position and the following buttons become available:



Clicking on these buttons will create a new dataset window displaying the currently selected property values plotted against series position or time.

When the  (Time Stamp) button is clicked, the Display Preferences dialog box opens as shown:





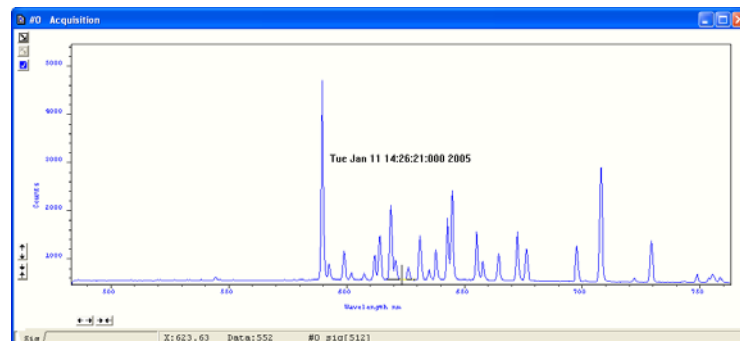

The Time Stamp feature allows you to add to the display the time at which the acquisition, or each scan in a kinetic series, occurred., e.g.:



- Time & date information, or time relative to the start of the acquisition can be displayed by selecting Enabled, then selecting the appropriate option in the Style drop down list.
- The position of the time stamp within the display can be set by adjusting the Vertical & Horizontal Alignment controls.
- The Color of the text can also be changed.
- The time can be made to print on a solid background by de-selecting Transparent.
- To remove the Time Stamp from the display de-select Enabled

After a Kinetic series acquisition has been taken, it can be played back again for analysis.

- To replay, click the  button and the acquisition will display again as taken
- To pause, click the  button
- To stop, click the  button

Playback autoscale performs a similar function to Autoscale acquisition and is selected from the button on the top of the main window ( = **On**,  = **Off**).

The sequence can also be viewed with different parameters set.

Select Sequence options from the Display drop-down menu and the **Sequence Setup** dialog box appears, e.g.:

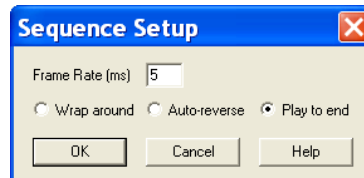

Select the parameters as required, click **OK**, then playback the sequence as normal.

NOTE: This can be exported as an MPEG or other similar file for use in presentations, etc. Please refer to the next section for further details on Handling Files.

The File drop-down menu on the Main Window has the following options:

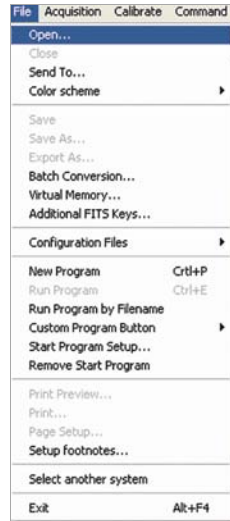

Some of the options available are typical 'Windows facilities' to **Open**, **Save**, **Print** files, etc, but some are specific to Andor's software to let you create or run programs.

7.1.1 - Open

Selecting **Open...** from the drop-down menu or clicking on the  button opens a standard dialog box, e.g.:

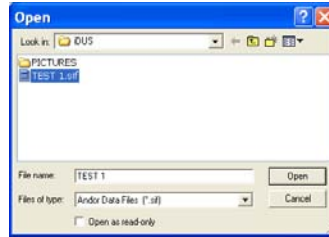

- If you select a Data file (.tif), the system launches a data window with the appropriate file displayed, e.g.:

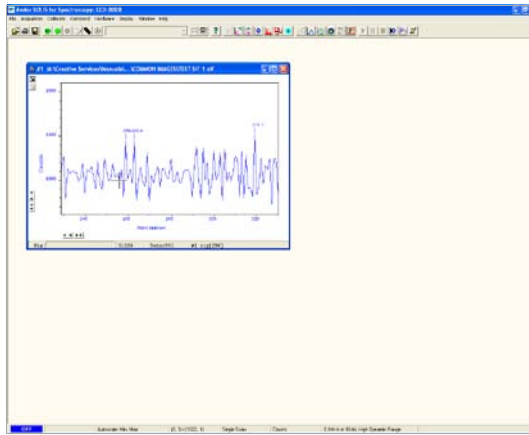

- If you open a Program file (.pgm), the system launches a Program Editor window and makes available a selection of editing tools on the Main Window), e.g.:

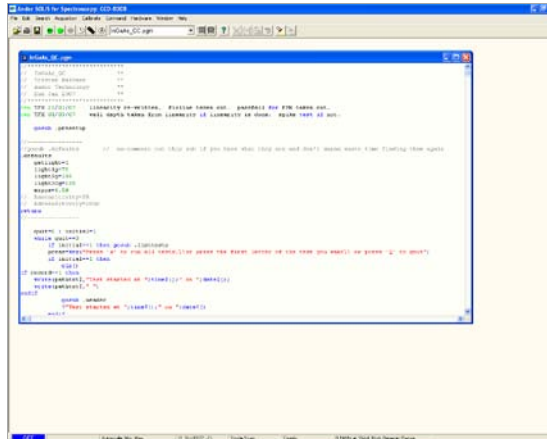

7.1.2 - Close

Close removes the active Data Window or Program Editor Window from the Main Window. You will be prompted to save any unsaved data to an appropriate filename.

7.1.3 - Save

Save or  stores the contents of an active and previously saved Data Window or Program Editor Window under the current filename.

7.1.4 - Save As

Save as... launches the Save As dialog box, which lets you save the contents of an active Data Window or Program Editor Window under a filename and in a directory of your choice.

NOTE: If data is saved as a .sif file, the information contained within file information is saved. If the data is exported to another file type, the information within file information is lost.

7.1.5 - Export As

Selecting **Export As...** opens the **Export As** dialog box, e.g.:

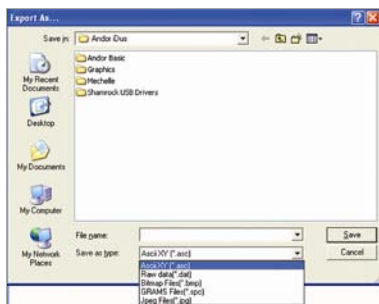

Depending on the Acquisition and Display modes selected, the file can be saved in one or more of the following formats:

- **ASCII (.asc)**
- **AVI (.avi)**
- **Bitmap (.bmp)**
- **GRAMS (.spc)**
- **Jpeg (.jpg)**
- **Raw data (.dat)**

Table 10 below shows a matrix of the actual combinations available.

Table 10: File export combinations

				EXPORT OPTIONS	
				ASCII	RAW DATA
Single	2D	3D		✓	✓
Kinetic	2D	3D		✓	✓

File extension = .asc

ASCII (**A**merican **S**tandard **C**ode for **I**nformation **I**nterchange) is the most common format for text files in computers and on the Internet. In an ASCII file, each alphabetic, numeric, or special character is represented with a 7-bit binary number. 128 possible characters are defined.

Exporting Data as ASCII text means you can subsequently import your data into other applications (such as spreadsheets) that use the ASCII format.

After you have selected **ASCII XY (*.asc)** from the **Save as type** drop-down menu, allocated a filename and clicked **Save**, the **Save data as** dialog box appears, e.g.:

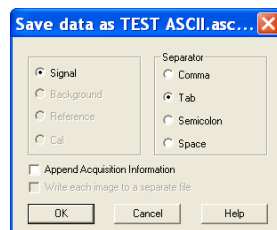

The radio buttons on the left allow you to choose whether you want to save the **Signal**, **Background**, **Reference** or **Cal** (calibration) data from the live data set.

The radio buttons on the right allow you to choose a character that will serve as a Separator between the numeric values in your raw data. You can then configure the importing application to recognize this separator (or delimiter) and in the case of a spreadsheet, display the data in a suitable configuration of rows and columns. In an application such as Microsoft Excel you can perform this configuration by means of a wizard, launched automatically as you import the ASCII file.

Exporting data as ASCII text causes all the data associated with the data set to be exported, not just the portion of the data that is currently being displayed. Data which have been acquired through Single track or Full Vertical Binning will typically be displayed on a spreadsheet as a single column.

Data from acquisitions involving Multi-Track, Imaging or Kinetic Series are normally displayed in rows and columns. The columns represent the height (and/or the member of the kinetic series) and the rows the width of the PDA-sensor.

7.1.5.2 - AVI

File extension = .avi

An **AVI** (Audio Video Interleaved) file is a sound and motion picture file that requires a special player.

After you have selected **AVI files (.avi)** from the **Save as type** drop-down menu, allocated a filename and clicked **Save**, the **AVI Export** dialog box appears, e.g.:

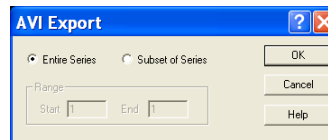

You can then select which series of data to export to the file.

7.1.5.3 - Bitmap

File extension = .bmp

BMP exports data in Microsoft Windows bitmap format that can be embedded into documents created in word processing and presentation packages, etc. If you adjust the image, it is the adjusted image that will be exported. After you have selected **Bitmap Files (*.bmp)** from the **Save as type** drop-down menu, allocated a filename and clicked **Save**, the file is saved.

7.1.5.4 - GRAMS

File extension = .spc

GRAMS (Graphic Relational Array Management System) is a software package that supports advanced data visualization and management. It is produced by Galactic Industries Corporation of Salem, New Hampshire.

After you have selected **GRAMS Files (*.spc)** from the **Save as type** drop-down menu, allocated a filename and clicked **Save**, the **Export #** dialog box appears, e.g. :

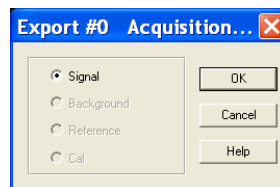

Provided data has been acquired in each format, you can select Signal, Background, Reference or Calibration data from the active data set.

7.1.5.5 - JPEG

File extension = .jpg

JPEG (Joint Photographic Experts Group) is a group of experts that develops and maintains standards for a suite of compression algorithms for computer image files. JPEG is a term used for any graphic image file produced by using a JPEG standard.

When you create a JPEG or convert an image from another format to a JPEG, you are asked to specify the quality of image you want. Since the highest quality results in the largest file, you can make a trade-off between the image quality and file size.

After you have selected **Jpeg Files (*.jpg)** from the **Save as type** drop-down menu, allocated a filename and clicked **Save**, the file is saved.

The **.dat** file comprises data only and has no header information of any kind. The original data set remains unchanged. After you have selected **Raw data (*.dat)** from the **Save as** type drop-down menu, allocated a filename and clicked **Save**, the **Export #** dialog box appears, e.g.

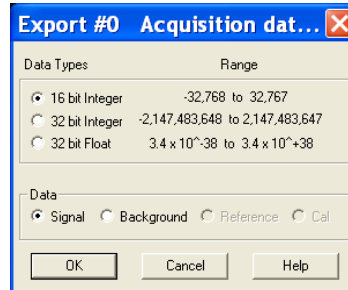

This allows the user to save a data set (currently in memory) to a file located on disk. A data set refers to a collection of data comprising one or more of the following subsets:

- **Signal**
- **Background**
- **Reference**
- **Cal**

A **.dat** file, however, will contain only one of the above data subsets.

Note: The Cal subset is used in radiometry/colorimetry measurements. It does not refer to the x-axis calibration of sig, bg or ref data.

The **.dat** file format reflects the PDA sensor format, e.g., with a PDA sensor of 1024 columns * 256 rows then the first 1024 data values in the **.dat** file correspond to the first row of the PDA, the second 1024 data values correspond to the second row, etc.

The **.dat** types range is shown in **table 11** on the next page.

Table 11: Types of .dat files

	DATA TYPE	NO. OF BYTES	RANGE
(1)	16 bit integer	2	-32,768 to 32,767
(2)	32 bit integer	4	-2,147,483,648 to 2,147,483,647
(3)	32 bit float	4	3.4×10^{-38} to $3.4 \times 10^{+38}$

(1) Saves a data set to a 16 bit integer **.dat** file.

NOTE: If a data value exceeds the limits of a 16-bit integer (<-32,768 OR > 32,767), that data value is truncated to the corresponding limit (e.g. if a data value is 36,000 units then the value is truncated to 32,767 units).

(2) Saves a data set to a 32 bit integer **.dat** file. The limits for the 32 bit integer are handled in similar fashion to the 16 bit integer above.

(3) Saves a data set to a 32 bit floating point **.dat** file.

When using your own software to handle a **.dat** file, you have to work out how many bytes to read in. Each 32 bit value requires 4 bytes to handle the value. Thus, for example, to read in a 32 bit **.dat** file consisting of 1024 data values, you would have to read in 4096 bytes in total.

File extension = .cfg

A configuration file contains the values that appear on the system's dialog boxes whenever the application is launched, or whenever a configuration file is newly loaded.

Using configuration files is an easy way to tailor the overall application set-up to suit particular experiments. Configuration files reside in the same directory as the executable (.exe) of the application itself.

The factory-supplied configuration file (.cfg) contains typical default settings. Each time you start up the system, the .cfg is loaded automatically.

The files are accessed from the **Configuration Files** menu on the **File** drop-down menu of the Main Window as shown:

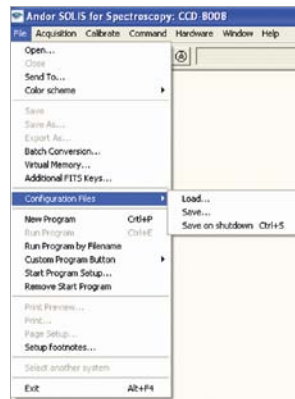

- **Load...** selects the configuration file you currently want to use. The system will immediately use the settings in the newly loaded file
- **Save...** stores your current settings under a filename and in a directory of your own choice. You can, if desired, overwrite an existing configuration file.
- **Save on shutdown** stores your current settings under a filename when the computer is shutdown.

The menus for working with Programs are selected from the File drop-down menu of the Main Window, e.g.:

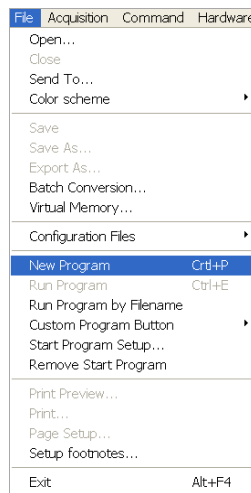

Working with Programs is explained in more detail in **Section 9**.

SECTION 8 - CALIBRATION

8.1 - INTRODUCTION TO CALIBRATION

The following calibration options for data displays are available from the Calibration Menu on the Main Window:

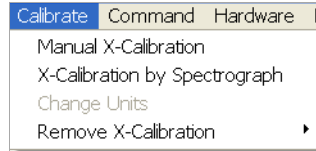

- **Manual X-Calibration:** lets you calibrate the x-axis of data displays by manually setting values (time, pixel number, wavelength, Raman shift or spatial position) against recognizable features of a particular 2D data trace.
- **X-Calibration by Spectrograph:** lets you calibrate the x-axis of your data displays with reference to your spectrograph's specifications. Calibration may be in wavelength or Raman shift.
- **Change Units:** lets you change the units on the x-axis of a data display (e.g. nm to μm , cm to pixel number, etc.)

In addition, the option **Remove X-Calibration** has 2 further options:

- Current Data returns the data in the active Data Window to its default pixel x-calibration.
- New Acquisitions causes future data to be acquired with the default pixel x-calibration.

8.2 - MANUAL X-CALIBRATION

Using newly acquired or previously stored data, select Manual X-Calibration from the Calibrate menu. The Manual X-Calibration dialog box appears, e.g.:

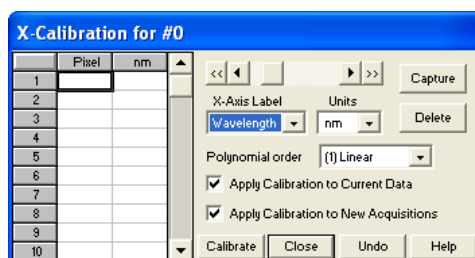

The number (#n) of the data window (or #0 in the case of an Acquisition Window) appears on the title bar of the dialog box.

To manually calibrate a data window, first use the drop-down lists on the Manual X-Calibration dialog box to choose the label and the units you wish to use for the x-axis. The available labels and units are shown here:

X-AXIS LABEL	UNITS
Wavelength	nm, μm , cm^{-1} , eV
Raman Shift	cm^{-1}
Position	μm , mm, cm, $\mu\text{i(nches)}$, in(ches)
Time	ms, secs
Pixel	pixels

Your chosen unit will appear on the top of the right-hand column of the two columns to the left of the Manual X-Calibration dialog box. Another drop-down list allows you to choose a polynomial order for your calibration. The following polynomial options are available:

POLYNOMIAL ORDER	DESCRIPTION
Linear	The linear fit is best for situations where only 2 or 3 spectral features can be identified.
Quadratic	A quadratic polynomial produces the best calibration fit if the known spectral features are located near the centre of the PDA sensor.
Cubic	A cubic polynomial produces the best calibration fit if the known spectral features are evenly distributed across the PDA sensor.

To perform the calibration:

1. Place the cross-hairs on a feature which you know to have a particular x-axis value and click Capture. If you wish to remove a point that you had previously selected, click Delete.
2. The pixel number will appear in the left-hand column. Against it, in the right-hand column, enter a value.

Repeat steps **1 & 2** for at least one other point. However, to achieve a good quality calibration you should choose a polynomial order fit commensurate with the spread of known spectral features across your sensor.

8.2.1 - Applying Calibration

Two check boxes on the Manual X-Calibration dialog box allow you to choose how the system should act upon the calibration details you have provided. You may select either or both of the following options:

1. **Apply Calibration to Current Data:** lets you change the x-axis calibration on an active data window whose filename (or #0 in the case of an Acquisition Window) appears on the title bar of the Manual X-Calibration dialog box.
2. **Apply Calibration to New Acquisitions:** the calibration details you have supplied in the Manual X-Calibration dialog box will be applied to any subsequent data acquisitions.

8.2.2 - Calibrate

Depending on the selections made using the check boxes on the Manual X-Calibration dialog box, clicking the Calibrate button will apply calibration to the active data window and/or to future data acquisitions

8.2.3 - When Manual X-Calibration goes wrong

In the event that Manual X-Calibration fails, it typically does so for one of two reasons:

Data that you are attempting to calibrate are non-monotonic (for example, a wavelength that should correspond to a single pixel value has several pixel values)

You have identified too few points (i.e. 0 or 1) for the system to perform a calibration. The system displays one or other of the following error dialog boxes:

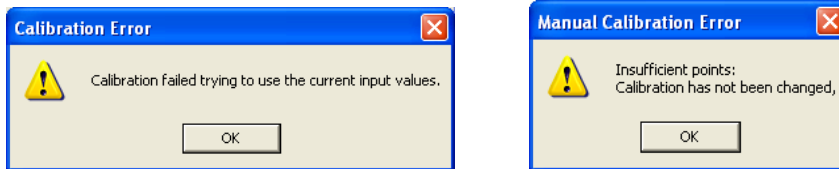

8.2.3.1 - Data are Non-Monotonic

Your data may be Non-Monotonic if you have entered an incorrect value for one or more points on your data trace. An instance of grossly inaccurate manual calibration is shown here:

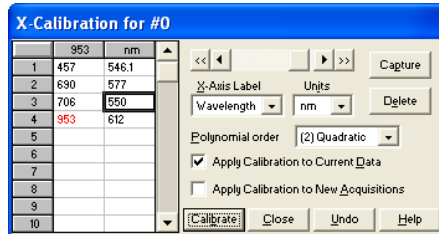

From Pixel 706 to Pixel 953 the user has indicated a fall in wavelength, despite the preceding rise in pixel 690. In such a case, an illegal non-monotonic calibration (as shown on the graph below) results.

The squares indicate points entered by a user, pixel values A, B and C illustrate the non-monotonicity of a sample wavelength of around 570 nm (i.e. three different pixel values for a single wavelength).

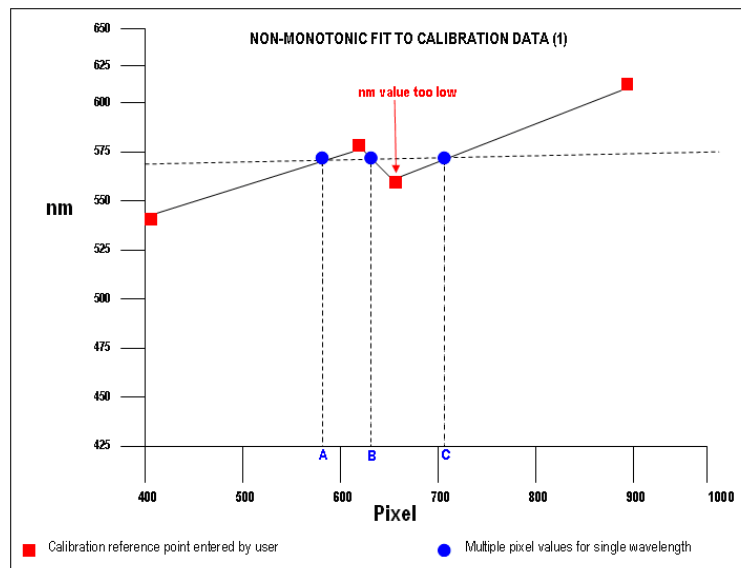

However, a non-monotonic calibration may come about even in cases where your data are not as grossly inaccurate as those shown in the example above. A non-monotonic calibration sometimes results if you attempt to calibrate points that are very close together on your trace, even if, for example, you are entering rising wavelength values against rising pixel values.

In its background processing, the system models the calibration data (the user-supplied reference points) as a cubic polynomial. Inaccurate values mapped to pixels that are close together may cause the system to model the calibration data as shown in the following graph.

Again certain (wavelength) values are non-monotonic relative to pixel value (see pixel values A and B, for example). The squares on the graph indicate points entered by the user, the rightmost point being at slightly too low a wavelength value.

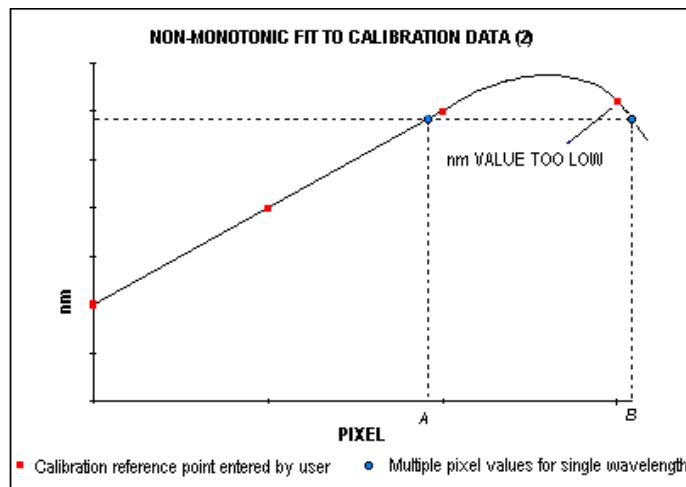

8.2.3.2 - Too few points

A calibration error will also occur if you have entered no data points, or only one data point, in the Manual X-Calibration dialog box. As general rule to obtain a good quality calibration, use more than five reference points, at regular intervals, across the full width of the PDA sensor.

8.2.4 - Undo

Click the Undo button to exit the Manual X-Calibration dialog box and to undo any calibrations that you have performed since entering the dialog box.

8.2.5 - Close

Click the Close button to exit the Manual X-Calibration dialog box.

8.3 - X-CALIBRATION BY SPECTROGRAPH

To calibrate data using the spectrograph, select the X-Calibration by Spectrograph option from the Calibration Menu. The Spectrograph X-Calibration dialog box will appear e.g.:

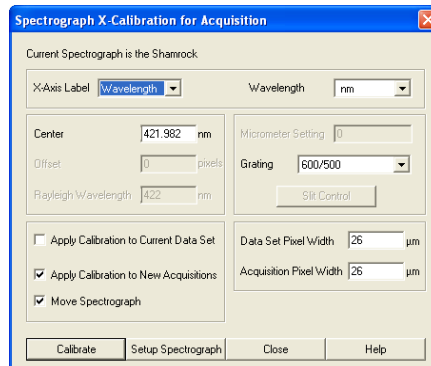

NOTE: This dialog box can also be opened by selecting the Setup Spectrograph option from the Hardware menu on the main window.

8.3.1 - Setup Spectrograph

Before you can perform a calibration using the spectrograph, you must ensure that the system knows which spectrograph you are using. To select the type of spectrograph to be used, click the Setup Spectrograph button on the Spectrograph X-Calibration dialog box and the Setup Spectrograph dialog box appears, e.g.:

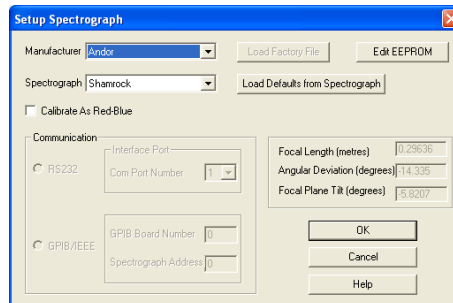

From the Manufacturer drop-down list, select the appropriate company name and from the Spectrograph drop-down list, select the model type being used, then click OK. The Spectrograph X-Calibration will appear again, with the details of the selected spectrograph.

With the exception of User Defined, selecting one of these options will cause the system to select and display (in grayed - i.e. non-writable - text boxes) your spectrograph's Focal Length, Angular Deviation and Focal Plane Tilt.

If you select the User Defined option from the drop-down list, you should consult the manufacturer's handbook for details, then key in the values for the spectrograph.

If you are using a motorized spectrograph, the system may be able to load spectrograph attributes (number of gratings, lines/mm, etc.) directly. The Load Defaults from Spectrograph button is enabled if an appropriate motorized spectrograph is chosen from the Spectrograph drop-down list.

Depending on the type of spectrograph being used, you can also select the type of interface needed from the Communication section of the dialog box.

8.3.1.1 - Calibrate As Red-Blue

Some PDA detectors readout data in the reverse direction to Andor cameras. In this case, the longer wavelengths (red) are to the left (as viewed from the detector), and shorter wavelengths (blue) are to the right.

If you tick the **Calibrate As Red-Blue** option in the Setup Spectrograph dialog box, the system then uses software to "reverse" the output of the detector when it generates a data window, thus presenting the display in the more usual orientation.

The radio buttons in the **Communication** section of the **Spectrograph Setup** dialog box can be used to establish an interface between your computer and the spectrograph.

If you are using an Andor Shamrock, you can also choose between USB or I²C control links. Select Shamrock Control from the Hardware drop-down menu and the Shamrock Control dialog box appears e.g.:

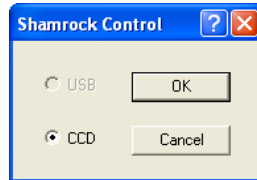

Select USB for USB control or for I²C control select CCD, then click OK.

NOTE: When a Shamrock is connected, the Shamrock icon;  appears in the menu bar of the main window.

In the event of an error in communication occurring, you will be prompted by a message, similar to the following:

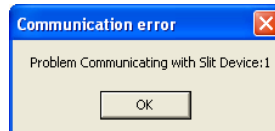

8.3.2.1 - Other Spectrographs

If you have selected the Oriel MS257 spectrograph for example, you can now **Load Factory File**. This file supplies the system with important configuration details of your particular spectrograph. It must be loaded for the system to control the spectrograph correctly. The Factory File will have been supplied on diskette with your MS257 spectrograph.

Performing **Load Factory File** lets you save the file contents to the .ini file included with the Solis software, after which the Factory File need not be loaded again.

When you click the **Load Factory File** button you will see a typical Windows 'Open File' dialog box. Select the directory and the filename of the file you wish to load, and click OK. The Factory File is now loaded.

8.3.2.2 - Reverse Spectrum

Some spectrographs produce somewhat 'atypical' spectra, where longer wavelengths (red) are to the left (as viewed from the detector), and shorter wavelengths (blue) are to the right. If you select the MS127 or the FICS spectrograph from the drop-down list for example, you will notice a tick in a **Reverse Spectrum** check box. Because both these spectrographs are of this type, the Reverse Spectrum check box is ticked by default when these spectrographs are selected.

The system then uses software to 'reverse' the output of the camera when it generates a data window, presenting the display in the more usual orientation.

You may, if you wish, disable the Reverse Spectrum function by clicking the check box.

8.3.2.3 - X-Axis Labels & Units

The Spectrograph X-Calibration Dialog box allows you to select, from scrollable drop-down list boxes, an X-Axis Label for your data window and an appropriate Unit of measurement. The following label & unit combinations are available:

X-Axis Label	Units
Wavelength	nm, μm , cm^{-1} , eV
Raman Shift	cm^{-1}

To change the x-axis units of an active data window which you have previously calibrated, select the **Change Units** option on the **Calibrate** menu. The **Change X-Calibration of Acquisition** dialog box will appear on your screen, e.g.:

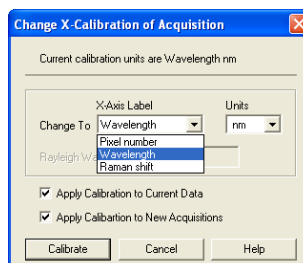

From the **X-Axis Label** drop-down list choose whether you want the x-axis to represent **Wavelength**, **Pixel Number** or **Raman Shift**. From the **Units** drop-down list, choose the units that you want to use for your recalibration. The available combinations depend on how the data were previously calibrated. If for instance, the data were previously calibrated in **Wavelength** and **Nanometres**, the available combinations for recalibration are:

Wavelength	nm, μm , cm^{-1} , eV
Raman Shift	cm^{-1}
Pixel Number	-

Table 12 shows the available combinations for all modes.

Table 12: Label & Unit changes

	X-Axis Label	Units	Can Change to:
0	User Type	-	
1	*Pixel Number (see NOTE 1. below)	-	
2	Wavelength	nm, μm , cm^{-1} , eV	1, 2, 3
3	Raman Shift	cm^{-1}	1, 2
4	Position	μm , mm, cm, $\mu\text{i(nches)}$, in(ches)	1, 4
5	Time	ms, s	1, 5
6	Sample	-	1

NOTES:

1. Changing from pixel number actually constitutes a new calibration and can only be performed by using Manual X-Calibration or X-Calibration by Spectrograph.
2. If you choose to recalibrate a data window in pixels, you will not be able to perform any further recalibrations on that window using the Change X-Calibration of Acquisition dialog box. If you save (under its previous filename) data that has been recalibrated in pixels, you will lose any previously saved calibration.

8.3.3 - Center Wavelength / Center of Raman Shift

The system allows you to adjust your spectrograph so that light of a chosen Wavelength or a chosen Raman Shift falls on the center of the PDA-sensor. These are referred to as **Center Wavelength** and **Center of Raman Shift** respectively.

If you have chosen Wavelength as your X-Axis Label, enter the Center Wavelength in the text box provided on the Spectrograph X-Calibration dialog box. If you have chosen Raman Shift as your X-Axis Label enter the Center of Raman Shift in the text box. In each instance, the value is expressed in the units you selected previously above.

If you enter too large or too small a value an error dialog box appears, e.g.:

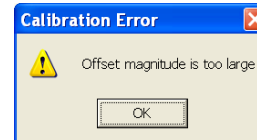
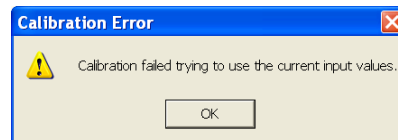

8.3.3.1 - Note on Raman Shift

The Raman Shift is calculated as follows:

If scatter is the wavelength of the Raman scattered light in nanometers and laser is the wavelength of the incident laser light in nanometers, then the Raman Shift in cm⁻¹ (i.e. rs) is calculated as follows:

$$rs = 107 \times [(scatter - laser) / (scatter \times laser)]$$

Thus, if **scatter < laser**, a negative Raman Shift (**anti-Stokes transition**) will result.

If **scatter > laser**, a positive Raman Shift (**Stokes transition**) will result.

Positive and negative values for Raman Shift may thus appear on the x-axis of a data window that is calibrated for Raman Shift, and may be used in the calibration process itself.

By entering a value in the Offset text box of the Spectrograph X-Calibration dialog box you can compensate for small misalignments of the detector or the wavelength drive in your spectrograph. A positive value will cause the x-axis of the data window to move to the right (relative to the trace) by the corresponding number of pixels. A negative value will cause the x-axis to move to the left.

NOTE: To assess the accuracy of any calibration you have performed, you will need a calibration spectral line source, such as a helium neon laser or a mercury vapor lamp. Ideally, set the spectrograph to one of the prominent spectral lines, take a scan and use the cursor on the data window to determine any offset (in pixels) of the line from its true wavelength.

If you have selected **Raman Shift** as your **X-Axis Label**, you must enter a value in nanometers for the **Rayleigh Wavelength**. In Raman Spectroscopy the Rayleigh Wavelength is that element of a spectrum line (in scattered radiation) whose wavelength is equal to that of the incident radiation (i.e. the laser wavelength) and is a product of ordinary or Rayleigh scattering.

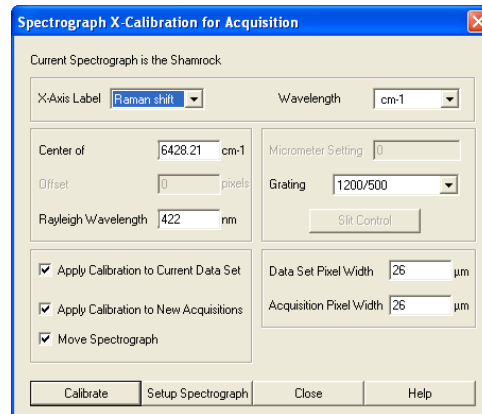

An error message will appear if you attempt to perform a calibration without having entered a valid Rayleigh Wavelength, e.g.:

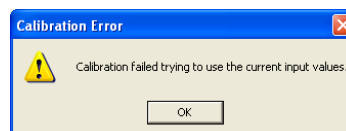

8.3.5 - Micrometer Setting

For certain non-motorized spectrographs, the system will calculate a Micrometer Setting that corresponds to the Grating and the **Center Wavelength / Center of Raman Shift** you have chosen. The Micrometer Setting allows you to manually adjust the angle of the diffraction grating (by means of the micrometer on the spectrograph housing), so that light of the wavelength / Raman shift of your choice falls on the centre of the PDA-sensor.

The Micrometer Setting option appears in a text box on the Spectrograph X-Calibration dialog box. You should use this value to manually set the micrometer on the spectrograph.

NOTES:

1. If you choose to enter a micrometer setting, the system will calculate a value for the **Center Wavelength / Center of Raman Shift** and vice versa. You need enter only one of the two values. Because Raman shift does not correlate linearly with wavelength (or pixel positions), the center column of pixels on the PDA-sensor (e.g. column 512 on a chip of 1024 pixels) is likely to be represented off-center on the x-axis of a data window linearly calibrated for Raman shift. Column and where appropriate, row number, are expressed in the form [x,y] on the status bar along the bottom edge of the data window.
2. If you choose Raman Shift as the X-Axis label, the **Center Wavelength** text box is relabeled **Center of Raman Shift**.
3. In the case of motorized spectrographs, the wavelength drive is under direct software control.

8.3.6 - Grating

From the scrollable drop-down list select the specification of the diffraction grating you are currently using. Grating specifications are shown as a line density followed by (where applicable) a blaze wavelength.

8.3.7 - Close

To exit the Spectrograph X-Calibration dialog box, click Close.

NOTE: The details you supply regarding your spectrograph, including any retrieved data, will subsequently appear by default whenever you open the Spectrograph X-Calibration dialog box. You can change them whenever you choose.

8.3.8 - Processing Data via the Command Line

8.3.8.1 - Command Line

The Command Line allows you to enter one-line commands that are written in the Andor Basic programming language. These commands are used to manipulate acquired data. Several command lines can be entered and they are separated by “:”.

To open the Command Line dialog box, either click the  button or select the Command Line option from the Command drop-down menu. The dialog box opens as per the following example:

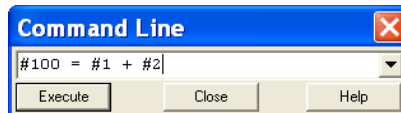

To run a command, click **Execute**. For further details of how to use the Andor Basic programming language, please refer to the User's Guide to Andor Basic.

8.3.8.2 - Calculations

The **Calculations** option lets you display the output of colorimetry calculations in a CIE Calculations Window.

8.3.8.3 - Configure Calculations

The Configure Calculations option lets you choose which colorimetry calculations you are going to perform and which parameters you are going to use.

For further information, please refer to Colorimetry Calculations in the **Radiometry Guide**.

SECTION 9 - WORKING WITH PROGRAMS

9.1 - WORKING WITH ANDOR BASIC PROGRAMS

9.1.1 - Command Line

The Command Line gives you ready access to all functions and arithmetic data processing of the Andor Basic programming language, without the need to write programs. However, to process the contents of a data set, the data set must first be in memory (RAM), and a corresponding Data Window will therefore be on screen.

To open the Command Line, click the  button.

As an example, the following entry on the command line adds together the data in the data sets #1 and #2, and stores the result in a third, possibly new, data set labeled #100. Thus **#100 = #1 + #2**:

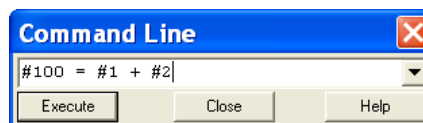

9.1.2 - Program Editor Window

Opening a program file, or selecting New Program from the File Menu launches a Program Editor Window where you can enter unformatted text:

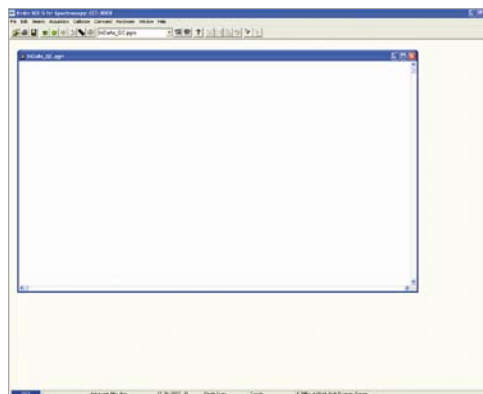





While you are working in the Program Editor Window, context sensitive help is available on the 'reserved words' of the programming language: with the cursor on or immediately after a reserved word, press Ctrl + F1.

9.1.3 - Accessing the Edit functions

Edit facilities are available either as edit buttons on the Main Window or as options on the Edit and Save Menus.

Some options (i.e. Cut and Copy) become available only when you have highlighted a segment of text; others are available only when preceded by another operation (Paste must be preceded by Cut or Copy). The following pages provide details of how to work with Andor Basic.

- Cut  or Copy  text that you have highlighted. Paste the text into a new position.
- Paste  inserts cut or copied text into the position following the cursor, or replaces text that you have highlighted.
- Undo  causes the text to revert to its state before the last change was made.

To search for items, either click on the Find  button on the Program Window or select Find... from the Search drop-down menu:



The Find dialog box appears:

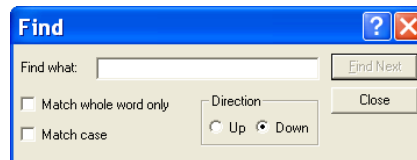

In the Find what text box, type the word or phrase (the 'search string') that you want to find.

Select Match whole word only to look for a complete word or for the same combination of capital and/or small letters as occur in the search string, select Match case.

Select Direction to determine in which way the search will be carried out.

To activate the search, click on Find Next or click the  button.

To replace items, select Replace... from the Search drop-down menu:

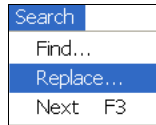

In the Find what text box, type in the search string and in the Replace with text box, type the word or phrase that you want to use instead, e.g.:

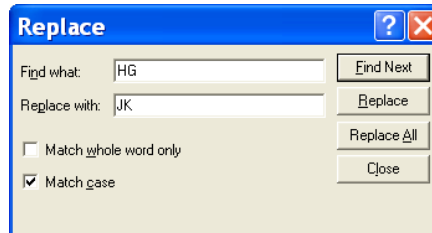

- Click the Replace button to change the next occurrence of the search string (or the highlighted search string if you have just used Find Next).
- Click Replace all to replace the search string wherever it occurs after the current cursor position.
- Check boxes let you Match whole word only or Match case.

To run a program, first ensure sure you have opened the appropriate .pgm file and ensure that the filename appears in the drop-down list box.

Secondly either click the  button or select Run Program from the File drop-down menu:

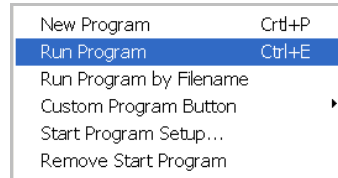

The program will now start. To change the name of the file you want to run, carry out one of the following actions:

- Open the drop-down list and click the name of the file
- Select an open Program Editor Window
- Open the .pgm file from the File menu

9.1.8 - Run Program by Filename

You may also run a program by means of the Run Program by Filename option on the File Menu.

Select Run Program by Filename from the File drop-down menu:

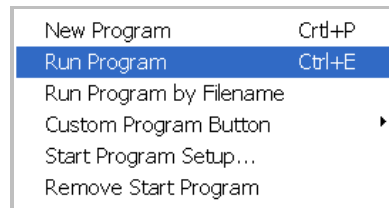

A standard Open dialog box appears, from which you may select the file whose contents you want to run. The file containing the program appears on screen as an iconized Program Editor Window and the program begins to execute immediately

9.1.9 - Entering Program Input

Any text-based input required by the program (i.e. in Andor Basic you have indicated that the user must manually enter a value at a particular point in the program's execution) is entered via an Input dialog box.

SECTION 10 - TUTORIAL

10.1 - CALIBRATING DATA USING FLUORESCENT ROOM LIGHT

10.1.1 - Aim & Requirements

The object of this experiment is to let you learn to use the iDus by applying a wavelength calibration using a typical fluorescent room light as a source. You will need the following items:

- **iDus InGaAs**
- **Fluorescent room light**
- **Spectrograph**

1. Attach the detector to the spectrograph. Ensure that the spectrograph has been fitted with a suitable diffraction grating (e.g. 600 l/mm) and that the spectrograph's micrometer (when using a manual spectrograph) has been set for a center wavelength of about 500 nm, i.e. in the middle of the visible range. For a 600 l/mm grating and center wavelength 500 nm the micrometer setting will be 250.
2. To remove dark signal, you should acquire data as background corrected counts. To select background corrected counts as your data type, open the Acquisition Menu on the Main Window and select the option Setup Data Type. On the Data Type dialog box click the Counts (Bg - corrected) radio button and close the Data Type dialog box by clicking the OK button.
3. You are now ready to acquire data. Acquire the background data first. To ensure that the background is acquired in darkness, cover the input slit of the spectrograph (if you have no shutter) and from the Acquisition Menu on the Main Window select the option Take Background. Background data are displayed on-screen under the Bg tab of an Acquisition Window. Uncover the input slit of the spectrograph.
4. Now acquire the signal data. These data will automatically be background corrected. Point the spectrograph's input slit at a fluorescent room light. From the Acquisition Menu on the Main Window select the option Take Signal (or alternatively, click the Take Signal button). By default the system will acquire signal data in Real Time mode, i.e. it will repeatedly acquire and display data until you press the Esc key or click the Abort Acquisition button on the Main Window.
5. Signal data are displayed on-screen under the Sig tab of an Acquisition Window. If the signal appears weak (i.e. the signal data are at low numbers of counts on the data-axis) or if the PDA is saturating (there are 'plateaus' on the trace at the top of the data-axis) try repositioning the spectrograph relative to the light in order to change the light level. The system's default exposure time of 25ms should be adequate for acquiring data from typical room lighting. When you are happy with the signal strength, press the Esc key or click the  button on the Main Window to stop acquiring data.
6. Now calibrate these signal data. Use manual calibration so that you can identify and place wavelength values against features of the data trace. A typical data trace for a fluorescent room light is shown below (wavelength in nanometers is marked against the main features):

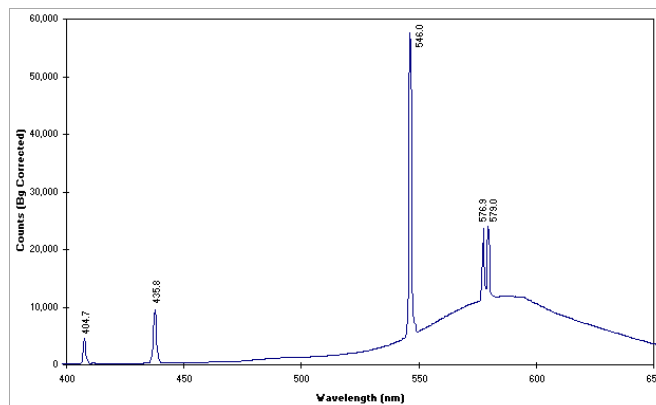

7. From the Calibrate Menu select Manual X-Calibration and make the following entries:

Set X-Axis Label Wavelength entry in the Units list box to nm

Apply Calibration to Current Data checkbox is ticked.

NOTE: The data range and relative intensities will vary with operating conditions and specification of equipment used.

8. Click the trace in the Acquisition Window at one of the points that you recognize as having a particular value (you may have to use the left and right arrow keys to 'fine tune' the cursor location to a peak). It is best to use peaks that are reasonably well separated when you perform a calibration. Attempting to calibrate both peaks of the yellow doublet is not recommended, for example. Click the Capture button on the X-Calibration dialog box. A pixel number (the x-axis co-ordinate of the point you selected on the trace) now appears in the two-column spreadsheet of the Manual X-Calibration dialog box. Beside the pixel number enter the wavelength that corresponds to the feature on the trace. Repeat this process for several other features on the trace then click the Calibrate button.
9. If you have identified one or more of the points on the trace incorrectly, so that the scale on the x-axis (if calibration were attempted) would not be monotonic, an error dialog box will warn you that the calibration of your trace has not been changed. Close the error dialog box by clicking the OK button.
10. On the Manual X-Calibration dialog box, re-examine the values you have entered. You may click the Delete button to remove any point you no longer wish to use for calibration, or you may overwrite a value that you previously entered with a new value. Click the Calibrate button again.

If you have selected and labeled the points on the trace accurately, the data in the Acquisition Window will now be calibrated in nm.

APPENDIX

A1.1 - GLOSSARY

If this is the first time you have used Andor's PDA, the glossary that follows will help familiarize you with its design philosophy and some of its key terminology.

A1.1.1 - PDA

A linear array of discrete photodiodes on an integrated-circuit chip used in digital detection systems.

A1.1.1.1 - InGaAs operation

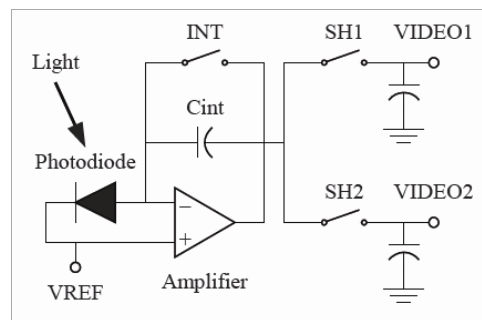

1. **INT** opens to allow charge to accumulate on **Cint**
2. **SH1** closes briefly to sample charge on **Cint** at start of signal
3. Light on **Photodiode** (and dark current) charges up **Cint**
4. At end of exposure **SH2** closes briefly to sample charge on **Cint**
5. The difference between **VIDEO1** & **VIDEO2** is calculated. This is the signal level.

A1.1.2 - Accumulation

Accumulation is the process by which data that have been acquired from a number of similar scans are added together in computer memory. This results in improved signal to noise ratio.

A1.1.3 - Acquisition

An Acquisition is taken to be the complete data capture process.

A1.1.4 - A/D Conversion

Charge from the PDA is initially read as an analog signal, ranging from zero to the saturation value. **A/D** (Analog to Digital) conversion changes the analog signal to a binary number which can then be manipulated by the computer.

A1.1.5 - Background

Background is a data acquisition made in darkness. It is made up of fixed pattern noise, and any signal due to dark current.

A1.1.6 - Counts

Counts refer to the digitization by the A/D conversion and are the basic unit in which data are displayed and processed. Depending on the particular version of the detection device, one count may, for example, be equated with a charge of 100 photoelectrons on a pixel of the PDA.

A1.1.7 - Dark Signal

Dark signal, a charge usually expressed as a number of electrons, is produced by the flow of dark current during the exposure time. All PDA's produce a dark current, an actual current that is measurable. Unlike silicon devices, some InGaAs sensors can exhibit both positive and negative dark signal in adjacent pixels.

The dark signal adds to your measured signal level, and increases the amount of noise in the measured signal. Since the dark signal varies with temperature, it can cause background values to increase over time. It also sets a limit on the useful exposure time. Reducing the temperature of the PDA reduces dark signal. It is important to cool the detector to reduce the dark signal.

To allow negative dark signal to be subtracted, baselines on 2.2 μm sensors are set considerably higher than on other models. The way that the signal is read out from the sensor in Andor's InGaAs cameras is different to that of a CCD. This means it is possible for a pixel to appear to have negative dark current.

When using an InGaAs camera the signal should always be background corrected; for this to work correctly it is important that the dark current of any pixel does not make the readout drop to (below) 0 counts. Therefore the BML is set higher on InGaAs cameras than for CCDs, and is especially high on the 2.2 μm InGaAs cameras.

A1.1.8 - Detection Limit

The Detection Limit is a measure of the smallest signal that can be detected in a single readout. The smallest signal is defined as the signal whose level is equal to the noise accompanying that signal, i.e. a signal to noise ratio (S/N) of unity.

Sources of noise are:

- **Shot noise of the signal itself**
- **Shot noise of any dark signal**
- **Readout noise**

If the signal is small, we can ignore its shot noise. Furthermore, if a suitably low operating temperature and short exposure time can be achieved, the lowest detection limit will equal the readout noise.

A1.1.9 - Exposure Time

The Exposure Time is the period during which the PDA collects light prior to readout.

Noise is a complex topic, the full exploration of which is beyond the scope of this glossary. Noise may, however, be broken down into two broad categories as follows:

- **Pixel Noise**
- **Fixed Pattern Noise**

These two categories are described in the paragraphs that follow.

Let us first attempt to define pixel noise. Assume that a light signal is falling on a pixel of the PDA. If the charge on the pixel is read, and the read process is repeated many times, the noise may be taken as the variation in the values read. The Root Mean Square (r.m.s.) of these variations is often used to express a value for noise. As a rule of thumb, the r.m.s. is four to six times smaller than the peak to peak variations in the count values read from the pixel. Pixel noise has three main constituents:

- **Readout noise**
- **Shot noise from the dark signal**
- **Shot noise from the light signal itself**

Shot noise cannot be removed because it is due to basic physical laws. Most simply defined, shot noise is the square root of the signal (or dark signal) measured in electrons.

Readout noise (which in our detectors is, in any case, low) is due to the amplifier and electronics: it is independent of dark signal and signal levels; it is only very slightly dependent on temperature; and it is present on every read, as a result of which it sets a limit on the best achievable noise performance.

Shot noise from the dark signal is dependent on the exposure time and is very dependent on the temperature; shot noise from the signal is additionally dependent on the signal level itself. If either the signal or the dark signal falls to zero, their respective shot noise also falls to zero.

The total pixel noise is not, however, simply the sum of the three main noise components (readout noise, shot noise from the dark signal, and shot noise from the signal).

Rather, the Root Sum Square (r.s.s.) gives a reasonable approximation - thus:

$$\text{total} = \text{sqrt}(\text{readnoise}^2 + \text{darkshot}^2 + \text{sigshot}^2)$$

where:

- **total** is the pixel noise
- **readnoise** is the readout noise
- **darkshot** is the shot noise of the dark signal
- **sigshot** is the shot noise of the signal

Shot Noise is due to basic physical laws and cannot be removed. Any signal, whether it be a dark signal or a light signal, will have shot noise associated with it. This is most simply defined as:

If the signal or dark signal = N electrons, the shot noise is the square root of N.

You can do nothing about the shot noise of your signal, but by choosing minimum exposures and operating the PDA at suitably low temperatures, the dark signal, and hence the noise from the dark signal, can be reduced.

Fixed Pattern Noise (FPN) consists of the differences in count values read out from individual pixels, even if no light is falling on the detector. These differences remain constant from read to read. The differences are due in part to a variation in the dark signal produced by each pixel, and in part to small irregularities that arise during the fabrication of the PDA.

Since fixed pattern noise is partly due to dark signal, it will change if the temperature changes, but because it is fixed, it can be completely removed from a measurement by background subtraction.

A1.1.11 - Pixel

A **Pixel** is an individual photosensor (or element) on a **PDA**.

A1.1.12 - Quantum Efficiency / Spectral Response

The glossary refers to signals as a number of electrons. More strictly speaking these are 'photoelectrons', created when a photon is absorbed. When an Infrared or visible photon is absorbed by the detector it can at best produce only one photoelectron. Photons of different wavelengths have different probabilities of producing a photoelectron and this probability is usually expressed as **Quantum Efficiency (QE)** or **Spectral Response**.

QE is a percentage measure of the probability of a single photon producing a photoelectron, while spectral response is the number of electrons that will be produced per unit photon energy. Many factors contribute to the QE of a PDA, but the most significant factor is the absorption coefficient of the Indium Gallium Arsenide that serves as the bulk material of the device.

A1.1.13 - Readout

Readout is the process by which data are taken from the pixels of the PDA and stored in computer memory. The pixels, which are arranged in a single row, are read out individually in sequence. Readout involves amplifying the charge on each pixel into a voltage, performing an A/D conversion, and storing the data in computer memory. The time taken to perform this operation is known as the 'read time'.

A1.1.14 - Saturation

Saturation is the largest signal the PDA can measure. A signal is measured in terms of the amount of charge that has built up in the individual pixels on the PDA-chip.

A1.1.15 - Scanning

In an acquired scan, the charge from the sensor undergoes A/D conversion and is acquired into computer memory so that it can be used for subsequent processing and display, i.e. it is 'read out'.

Unlike silicon devices, PDA's require to be told to "open" to light before they become responsive. After the predetermined exposure time, they "close" again. Only light falling during the exposure (indicated by the fire pulse) is acquired by the camera.

A1.1.16 - Signal to Noise Ratio

The **Signal to Noise Ratio** (more commonly abbreviated as **S/N** or **SNR**) is the ratio between a given signal and the noise associated with that signal. Noise has a fixed component, and a variable component (shot noise) which is the square root of the signal. Thus, the Signal to Noise Ratio usually increases (improves) as the signal increases.

The maximum Signal to Noise Ratio is the ratio between the maximum signal (i.e. the saturation level) and the noise associated with that signal. At near saturation levels the dominant source of noise is the shot noise of the signal.

A1.2- MECHANICAL DIMENSIONS

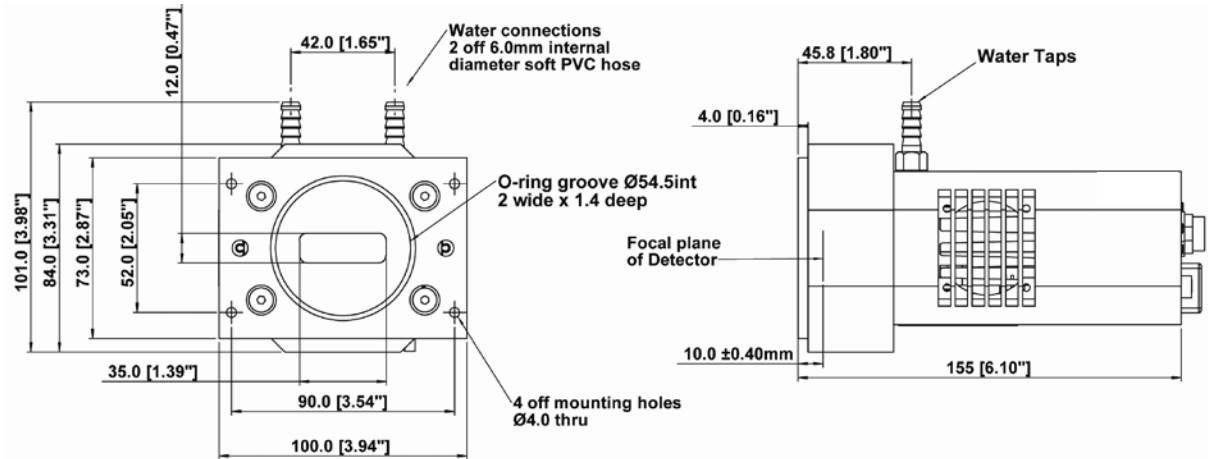

NOTES:

1. There are two mounting holes (¼-20UNC), one located on the top of the CCD head and one on the bottom. They are positioned centrally at a distance of 22.3 mm from the front of the front face.
2. Cable clearances required at rear of camera:

Exit connector type	Clearance
Power supply cable	90mm
USB cable	60mm
Right angled variant of power supply cable	40mm

In these conditions:

1. 'Buyer' means the person who accepts a quotation of the seller for the sale of the goods or whose order for the goods is accepted by the seller.
'Goods' means the goods (including any instalment of the goods or any parts for them) which the seller is to supply in accordance with these conditions.
'Seller' means Andor Technology plc.
'conditions' means the standard terms and conditions of sale set out in this document and (unless the context otherwise requires) includes any special terms and conditions agreed in writing between the buyer and seller.
'Contract' means the contract for the purchase and sale of the goods.
'Writing' includes telex, cable, facsimile transmission and comparable means of communication.
2. Any reference in these conditions to any provision of a statute shall be construed as a reference to that provision as amended, re-enacted or extended at the relevant time.
3. The headings in these conditions are for convenience only and shall not affect their interpretation.

A1.4 WARRANTIES & LIABILITY

1. Subject to these conditions set out below, the seller warrants that the goods will correspond with their specification at the time of delivery and will be free from defects in material and workmanship for a period of 12 months from the date of delivery.
2. The above warranty is given by the seller subject to the following conditions:
 - 2.1 The seller shall be under no liability in respect of any defect in the goods arising from any drawing, design or specifications supplied by the buyer;
 - 2.3 The seller shall be under no liability in respect of any defect arising from fair wear and tear, wilful damage, negligence, abnormal working conditions, failure to follow the seller's instructions (whether oral or in writing), misuse or alteration or repair of the goods without the seller's approval;
 - 2.3 The seller shall be under no liability under the above warranty (or other warranty, condition or guarantee) if the total price for the goods has not been paid by the due date for payment;
 - 2.4 The above warranty does not extend to parts, material or equipment not manufactured by the seller, in respect of which the buyer shall only be entitled to the benefit of any such warranty or guarantee as is given by the manufacturer to the seller.
3. Subject as expressly provided in these conditions, and except where the goods are sold to a person dealing as a consumer (within the meaning of the unfair contract terms act 1977), all warranties, conditions or other terms implied by statute or common law are excluded to the fullest extent permitted by law.
4. Any claim by the buyer which is based on any defect in the quality or condition of the goods or their failure to correspond with specification shall (whether or not delivery is refused by the buyer) be notified in writing to the seller within 7 days from the date of delivery or (where the defect or failure was not apparent on reasonable inspection) discovery of the defect or failure. If delivery is not refused, and the buyer does not notify the seller accordingly, the buyer shall not be entitled to reject the goods and the seller shall have no liability for such defect or failure, and the buyer shall be bound to pay the price as if the goods had been delivered in accordance with the contract. in no event shall the buyer be entitled to reject the goods on the basis of any defect or failure which is so slight that it would be unreasonable for him to reject them.
5. Where any valid claim in respect of the goods which is based on any defect in the quality or condition of the goods or their failure to meet specification is notified to the seller in accordance with these conditions, the seller shall be entitled to replace the goods (or the part in question) free of charge or, at the seller's sole discretion, refund to the buyer the price of the goods (or a proportionate part of the price), but the seller shall have no further liability to the buyer.

6. Except in respect of death or personal injury caused by the seller's negligence, the seller shall not be liable to the buyer by reason of any representation (unless fraudulent), or any implied warranty, condition or other term, or any duty at common law, or under the express terms of the contract, for any indirect, special or consequential loss or damage (whether for loss of profit or otherwise), costs, expenses or other claims for compensation whatsoever (whether caused by the negligence of the seller, its employees or against otherwise) which arise out of or in connection with the supply of the goods, or their use or resale by the buyer and the entire liability of the seller under or in connection with the contract shall not exceed the price of the goods, except as expressly provided in these conditions.
7. The seller shall not be liable to the buyer or be deemed to be in breach of the contract by reason of any delay in performing, or any failure to perform, any of the seller's obligations in relation to the goods, if the delay or failure was due to any cause beyond the seller's reasonable control. without prejudice to the generality of the foregoing, the following shall be regarded as causes beyond the seller's reasonable control:
 - 7.1 Act of god, explosion, flood, tempest, fire or accident;
 - 7.2 War or threat of war, sabotage, insurrection, civil disturbance or requisition;
 - 7.3 Acts, restrictions, regulations, bye-laws, prohibitions or measures of any kind on the part of any governmental, parliamentary or local authority;
 - 7.4 Import or export regulations or embargoes;
 - 7.5 Strikes, lock-outs or other industrial actions or trade disputes (whether involving employees of the seller or of third party);
 - 7.6 Difficulties in obtaining raw materials, labour, fuel, parts or machinery;
 - 7.7 Power failure or breakdown in machinery.