

SFG Spectrometers

Sum Frequency Generation
Vibrational Spectroscopy

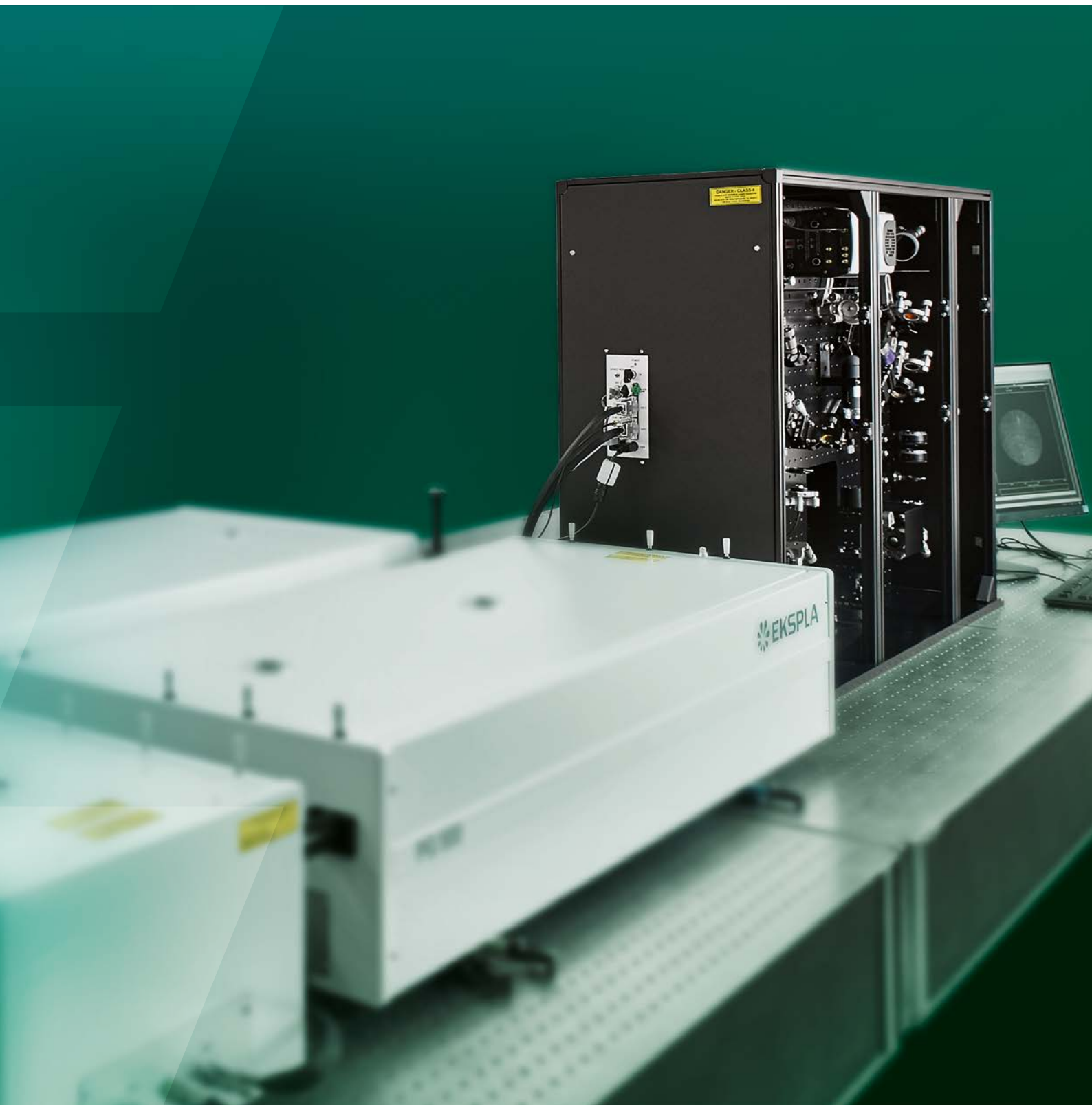

Sum Frequency Generation Vibrational Spectroscopy

Sum Frequency Generation Vibrational Spectroscopy (SFG-VS) is a powerful and versatile method for in-situ investigation of surfaces and interfaces. In SFG-VS experiment a pulsed tunable infrared IR (ω_{IR}) laser beam is mixed with a visible VIS (ω_{VIS}) beam to produce an output at the sum frequency ($\omega_{SFG} = \omega_{IR} + \omega_{VIS}$). SFG is a second order nonlinear process, which is allowed only in media without inversion symmetry. At surfaces or interfaces inversion symmetry is necessarily broken, that makes SFG highly surface specific. As the IR wavelength is scanned, active

vibrational modes of molecules at the interface give a resonant contribution to SF signal. The resonant enhancement provides spectral information on surface characteristic vibrational transitions.

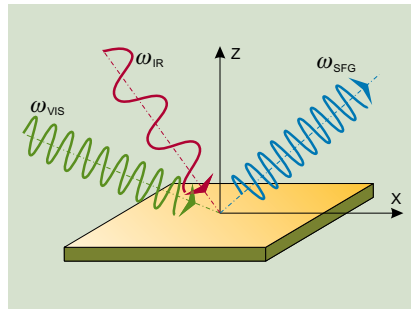

ADVANTAGES

- ▶ Intrinsically surface specific
- ▶ Selective to adsorbed species
- ▶ Sensitive to submonolayer of molecules
- ▶ Applicable to all interfaces accessible to light
- ▶ Nondestructive
- ▶ Capable of high spectral and spatial resolution

SPECTRA EXAMPLES

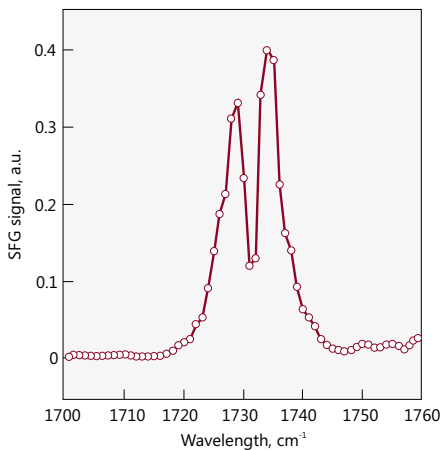

SFG spectra of monoolein surface, 1 cm^{-1} scan step, 200 acquisitions per step.

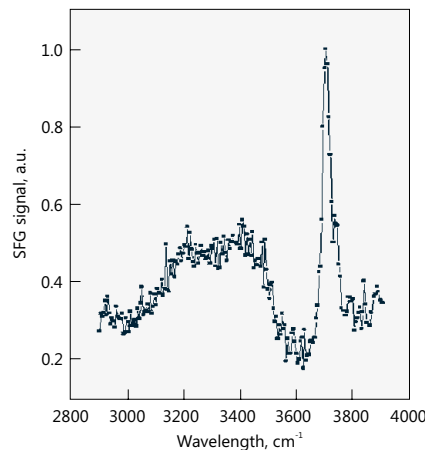

Water-air interface spectra, 200 acquisitions per step.

Courtesy of University of Michigan

APPLICATIONS

- ▶ Investigation of surfaces and interfaces of solids, liquids, polymers, biological membranes and other systems
- ▶ Studies of surface structure, chemical composition and molecular orientation
- ▶ Remote sensing in hostile environment
- ▶ Investigation of surface reactions under real atmosphere, catalysis, surface dynamics
- ▶ Studies of epitaxial growth, electrochemistry, material and environmental problems

Design of the SFG Spectrometer

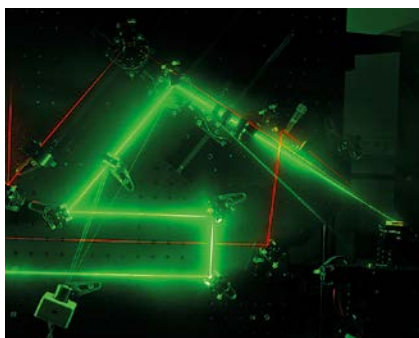

Sum frequency generation (SFG) spectrometer is based on picosecond pump laser and optical parametric generator (OPG) with difference frequency generation (DFG) extension. Solid state mode-locked Nd:YAG laser featuring high pulse duration and energy stability is used in the system. Fundamental laser radiation splits into several channels in multichannel beams delivery unit. Two of these beams are used for pumping OPG and DFG. Small part of laser output beam, usually with doubled frequency (532 nm), is directed to VIS channel of SFG spectrometer. IR channel of spectrometer is pumped by DFG output beam.

The sizes of individual compartments, positions of apertures and beams heights are fitted. As a result SFG spectrometer takes less space in laboratory. Standard versions usually fit on 1000×2400 mm optical table. All beams among laser, harmonics module, parametric generator, SFG box are enclosed in tubes. For example

beam dedicated for VIS channel passes through OPG compartment only to minimize the risk of accident with dangerous high intensity laser radiation. It makes Ekspla spectrometer substantially safer comparing to home-made SFG-VS setups. Also optical parameters, like beam diameter, pulse energy, delays between channels are perfectly matched. Motorised switch of IR Polarisation, motorisation of delay line are included in standard configuration.

We designed our spectrometer thinking about user friendly operation. Many components of the system are automated and controlled from PC. The opto-mechanical holders that need to be tuned often during routine operation are located around sample area and can be easily accessed without walking around the optical table. According to user needs different level of automation can be proposed, starting from most simple mechanical setup to most advanced fully motorized version.

Detection system consists of monochromator with high stray light rejection and gated PMT based SF signal detector. The feature of such design is ability to perform measurements in room lighting. Second parallel detection channel is available as an option. All system components are controlled from single dedicated software. Program contains many useful instruments for automatic

SYSTEM COMPONENTS

- ▶ Picosecond mode-locked Nd:YAG laser
- ▶ Multichannel beam delivery unit
- ▶ Picosecond optical parametric generator
- ▶ Spectroscopy module
- ▶ Monochromator
- ▶ PMT based signal detectors
- ▶ Data acquisition system
- ▶ Dedicated LabView® software package for system control

SFG spectra recording, dynamics monitoring, X-Y sample mapping, azimuthal scan and system parameters monitoring.

Ekspla offers three common SFG spectrometer models for classical picosecond scanning SFG vibrational spectroscopy and several specialized models for most demanding users. Basic models are: **SFG Classic**, **SFG Advanced** and **Double resonance SFG**, **Phase sensitive**. They differ by IR beam tuning ranges and available VIS beam wavelengths (please see specifications page). Other models: **Classic + Phase-sensitive SFG** and **SFG microscope** provides unique features, which are described on next pages of this brochure.

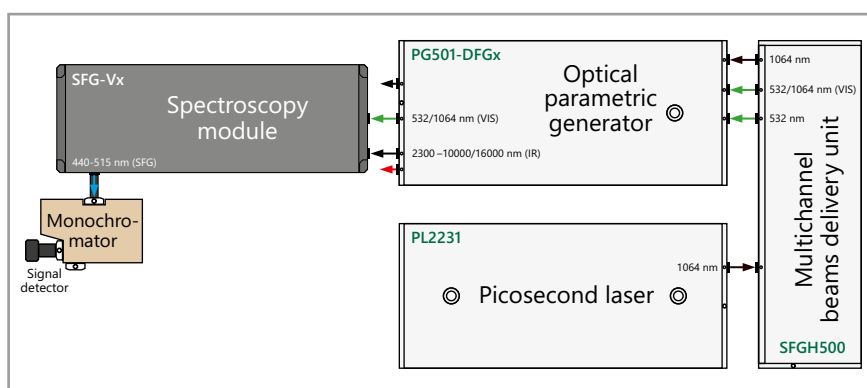

Schematic layout of SFG Classic spectrometer.

SFG Spectrometer Modifications and Options

DOUBLE RESONANCE MODEL

Both IR and VIS wavelengths are tunable in Double resonance SFG spectrometer model. This two-dimensional spectroscopy is more selective than single resonant SFG and applicable even to media with strong fluorescence. Double resonant SFG allows investigation of vibrational

mode coupling to electron states at a surface.

Double resonance enables the use of another wavelength for VIS beam if the sample has strong absorption at 532 nm and 1064 nm. Two outputs PL2230 laser is used for this spectrometer.



External view of Double resonance SFG spectrometer.

SFG MICROSCOPE

SFG-VS spectroscopy combined with micrometers spatial resolution provides unique ability to investigate spatial and chemical variations across the surface as a function of time. An example of such application is chemical imaging of corrosion. SFG microscopy reveals presence of highly-coordinated complexes of molecules at particular stage of this process.

SFG spectrometer offered by Ekspla uses far-field image formation technique. Illuminated area on the sample surface is substantially bigger than in regular SFG spectrometer. Using blazed grating and unique design optical system, image of surface plane is translated to matrix of ICCD camera. This way we can record distribution of SF signal at particular wavelength. For complete spectral and spatial information it is necessary to record multiple surface pictures

at different wavelength. Integrated software package provides ability to visualize measured data making various cross sections: position-, wavelength- or time-dependent.



Detection part of SFG microscope.

MODIFICATIONS

- ▶ Double resonance SFG spectrometer – allows investigation of vibrational mode coupling to electron states at a surface
- ▶ Phase sensitive SFG spectrometer – allows measurement of the complex spectra of surface nonlinear response coefficients
- ▶ SFG microscope – provides spectral and spatial surface information with micrometers resolution

OPTIONS

- ▶ Single or double wavelength VIS beam: 532 nm and/or 1064 nm
- ▶ One or two detection channels: main signal and reference
- ▶ Second harmonic generation surface spectroscopy option
- ▶ High resolution option – down to 2 cm^{-1}
- ▶ Motorized VIS and IR beams alignment system

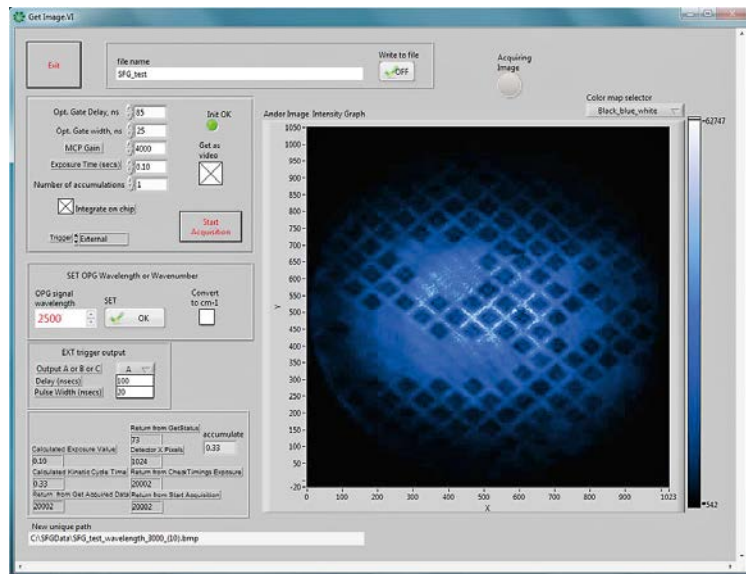
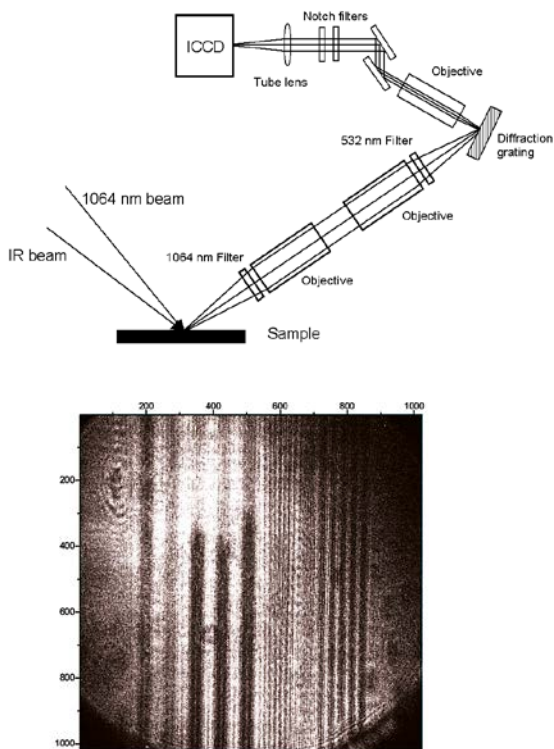

SFG signal from etched gold pattern. Image taken at $\omega_{IR} = 3333 \text{ cm}^{-1}$. Grid period $50 \mu\text{m}$.

An image of ODT covered etched gold sample.

The lines are spaced, in order left-right 20, 5, 2, and 8 micrometers. Image taken at $\omega_{IR} = 2875 \text{ cm}^{-1}$ and acquired for 5000 laser shots.

Courtesy of University of Houston

SFG MICROSCOPE + CLASSIC SFG SPECTROMETER IN ONE UNIT



PHASE-SENSITIVE SFG SPECTROMETER

Phase sensitive measurements with spectral resolution up to 6 cm^{-1} (2 cm^{-1})

In conventional SFG-VS intensity of SF signal is measured. It is proportional to the square of second order nonlinear susceptibility $I_{\text{SF}} \sim |\chi^{(2)}|^2$. However, $\chi^{(2)}$ is complex, and for complete information, we need to know both the amplitude and the phase. This will allow us to determine the absolute direction in which the bonds are pointing and characterize their tilt angle with respect to the surface. Measurement of the phase of an

optical wave requires an interference scheme. Mixing the wave of interest with a reference wave of known phase generates an interference pattern, from which the phase of the wave can be deduced.

In practice Phase-sensitive SFG experimental setup includes two samples generating SF signal simultaneously. One sample (usually called local oscillator) has well known and flat spectral response. Second one is investigated sample. The excitation beams are directed to first sample, where SFG beam is generated. Later

all three beams are retranslated to the second sample, where another SFG beam is generated. Due to electromagnetic waves coherence both SFG beam are interfering. Setup contains the phase modular located on the SFG beam path between samples. We are able to change the phase of SFG beam by rotating it. This way we are recording two-dimensional interfererogram with wavelength and phase shift on x and y axis. Using fitting algorithms we are able to calculate the amplitude and phase of SF signal.

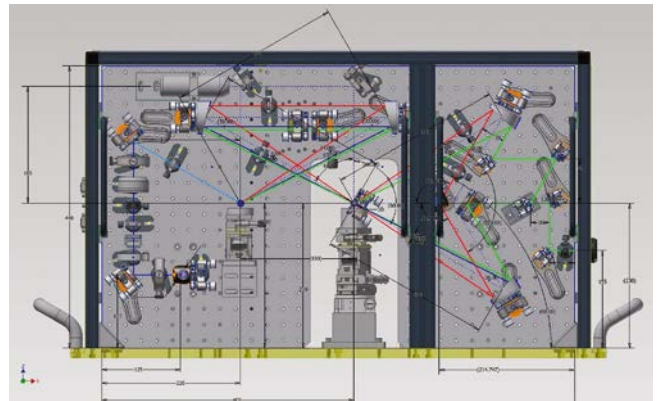

Spectroscopy module of Phase-sensitive SFG spectrometer: internal view (left) and 3D drawing (right).

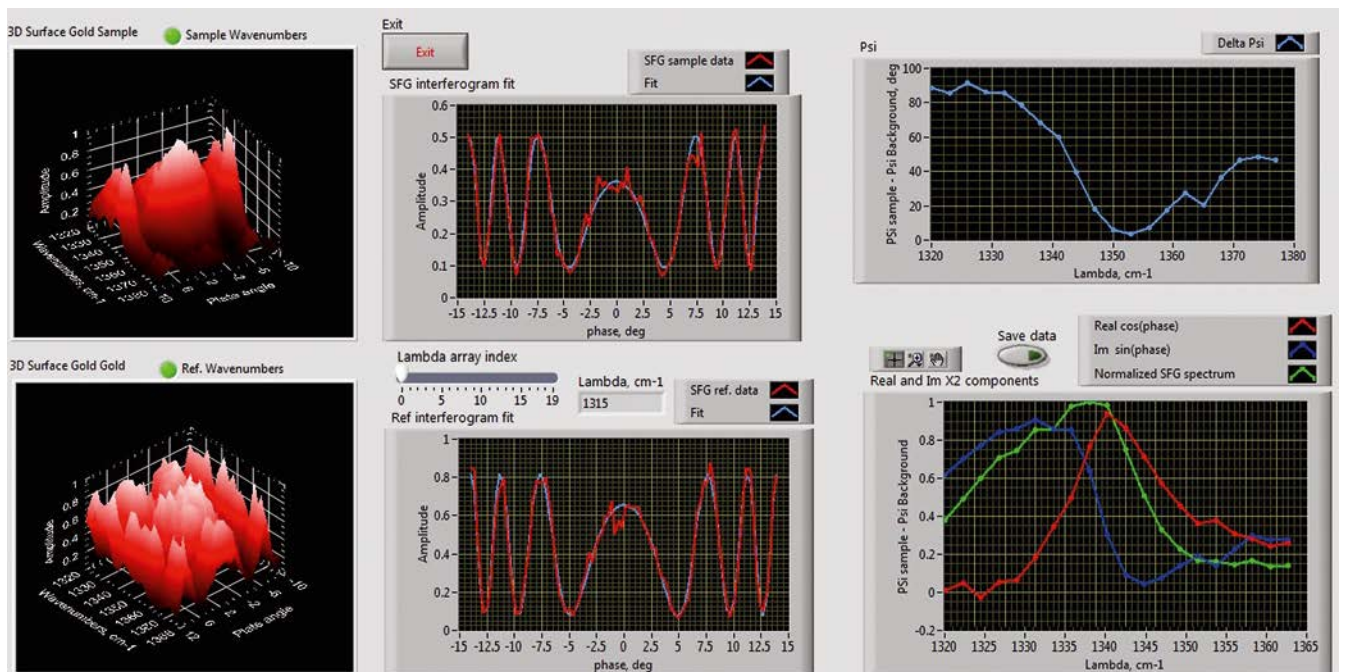

Phase-sensitive SFG spectrometer software window showing interferograms of AZO (azophenylcarbazole) dyes on the Au surface and fitted SF spectra with amplitude and phase distinguished.

PHASE SENSITIVE SFG + CLASSIC SFG SPECTROMETER IN ONE UNIT

Interference measurements of SFG signals from reference sample and the investigated sample for Phase-sensitive configuration.

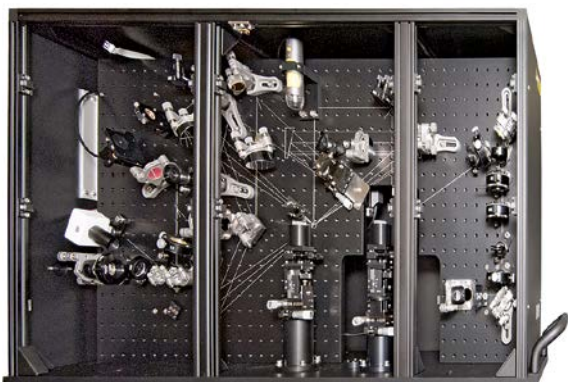

Classic + Phase sensitive versions in one unit

Switchable setup. Phase sensitiv / "Classic" ("Advanced") ; Top/ Bottom configuration.

Switch: VIS beam manual. IR mirrors motorised, BaF₂ lens manual.

Path length to the sample is same in all configuration

Motorised polarisation control.

VIS beam 532 nm. IR 2,3- up to 10 (16) μm.

OPTIONS

Spectrometer has "classic" and "Phase-sensitive" properties:

- ▶ Easy switching between setups
- ▶ Adjustable spot size for classic configuration

("Classic") configuration

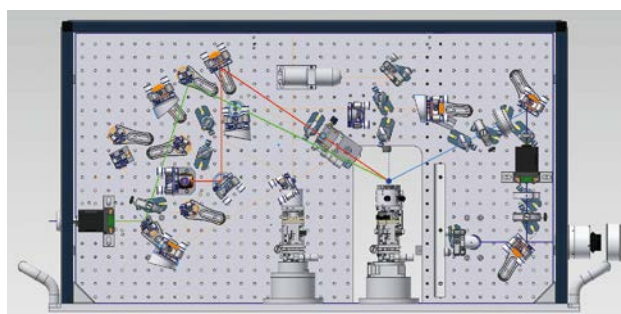

Tunable beam size for IR beam.

Beams are Focused with Lens. (BaF₂ lens for IR beam).

"Classic" configuration. IR 2.3-10 μm (up to 16 μm).

Phase sensitive, Top (Reflection- Reflection) configuration

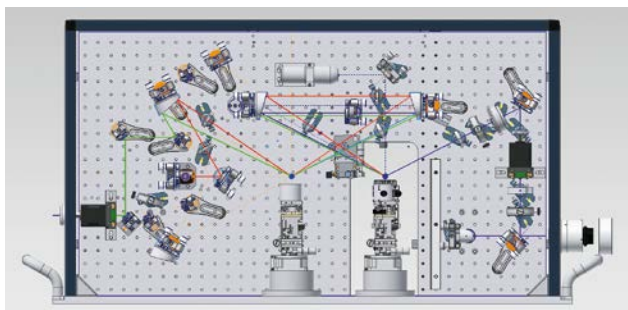

Fixed beams sizes on the sample. VIS and IR beams.

Beams are Focused with Parabolic mirrors.

Interference configuration for Phase measurement.

IR 2.3-10 μm.

Phase sensitive, Transmission-reflection configuration

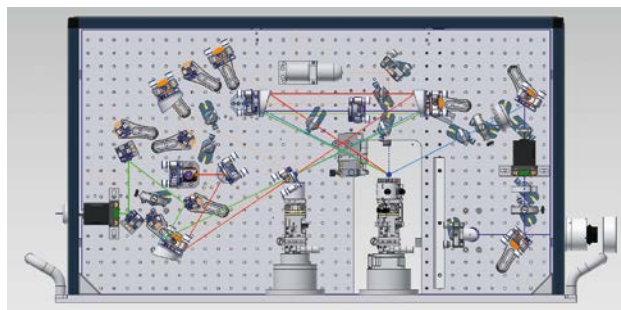

Fixed beams sizes on the sample. VIS and IR beams.

Beams are Focused with Parabolic mirrors.

Interference configuration for Phase measurement.

IR 2.3-3,5 μm .

NARROWBAND SFG SYSTEM <2 cm⁻¹

Spectral resolution in of narrowband SFG is determined by light source – OPA.

Monochromator is used only as filter.

Light source for IR: PG511. Line width of mid-IR < 2 cm⁻¹.

Synchronously pumped optical parametric generator with OPO with long focal length resonator.

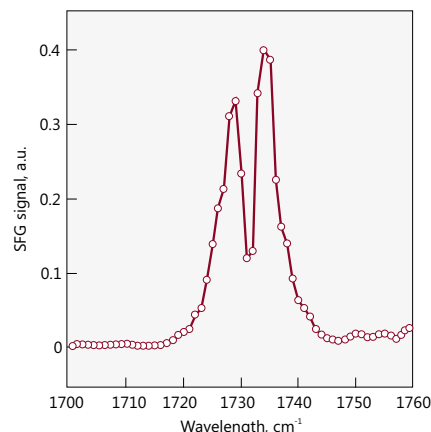

SFG spectra of monoolein surface, 1 cm⁻¹ scan step, 200 acquisitions per step.

Main System Components

PICOSECOND MODE-LOCKED Nd:YAG LASER



The heart of the spectrometer is solid-state picosecond laser. Its reliability is critical to perfect spectrometer operation and relevance of measured data. Two standard models of high energy lasers are dedicated for SFG spectrometers.

Model PL2230 is fully diode pumped, which means that master oscillator and all following amplification stages are diode pumped. It features great long term parameters stability and

minimal maintenance requirements. This model provides up to 40 mJ per pulse output energy, which in most cases is enough for pumping OPG and VIS channel of SFG spectrometer.

Model PL2230 is available for double resonance SFG. This model usually is used for pumping of two independent OPG's. Such configuration is used in double resonance SFG version.

MULTICHANNEL BEAMS DELIVERY UNIT

Fundamental laser radiation needs to be split into several channels and converted to different wavelengths. Tunable IR radiation is generated in picosecond optical parametric generator (OPG). Large portion of laser output is converted into second or third harmonics and used for

OPG pumping. Residual beam is spatially filtered, delayed and directed into SFG spectrometer as VIS channel. Usually it is converted into second harmonic (532 nm), but in some cases can be used also at fundamental

wavelength (1064 nm) or tunable in visible range, when second OPG is used.

Multichannel beams delivery unit SFGHX00 series provides all these features. Additionally it contains automatized VIS channel input energy monitoring and control.

The VIS channel wavelength (if double wavelength option is included) is changed manually. Setup also includes all needed separators and filters to block residual radiation and prevent it from reaching a sample.

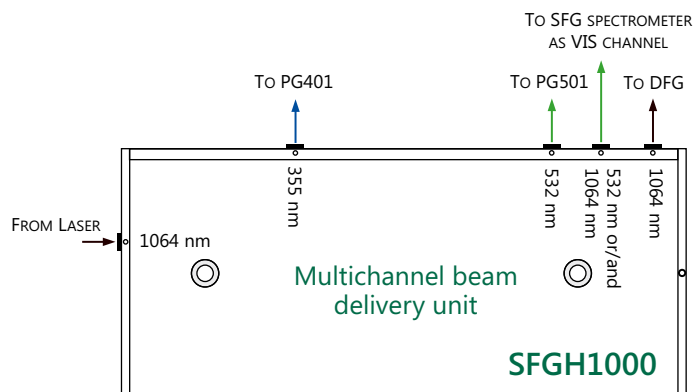

An example of **Multichannel beams delivery unit** used for Double resonance SFG spectrometer.

PICOSECOND OPTICAL PARAMETRIC GENERATOR

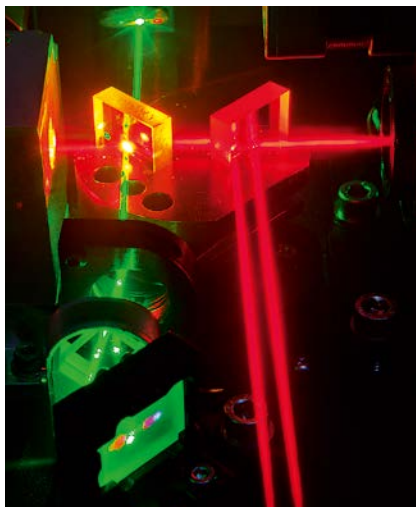

PG501 series picosecond optical parametric generator (OPG) feature high pulse energy and narrow linewidth. It is used for generation of tunable wavelength in broad spectral range. In SFG spectrometer it provides middle infrared radiation for IR channel.

DFG stage extends tuning range to mid IR, which corresponds to molecular vibrational fingerprints. Depending of OPG model, DFG output can cover spectral range 2.3–10 μm or 2.3–16 μm. All residual wavelengths are carefully filtered preventing residual radiation from reaching a

sample. Visible laser pointer is installed inside each unit and aligned in-line with IR beam. It helps to manage invisible mid IR radiation and direct it through multiple optical elements into a sample.

Some SFG-VS studies require better than 6 cm⁻¹ spectral resolution. In such cases Ekspla offers unique design PG511 series OPG. In this system seed is generated in synchronously pumped optical parametric oscillator (SPOPO), which is temporally synchronized with laser regenerative amplifier. In this configuration radiation spectral width is narrowed down to 2 cm⁻¹ in mid IR range.

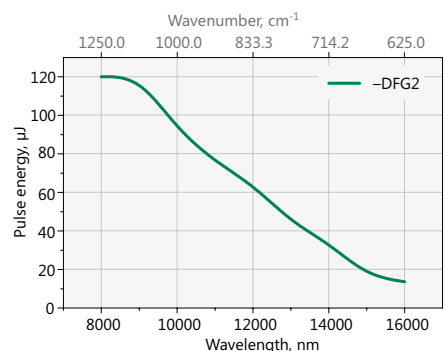
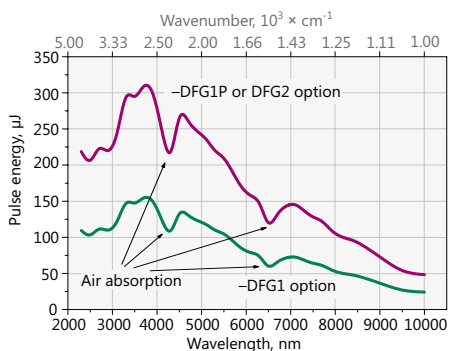

Typical PG501-DFGx output energy curve in 2 300 – 10 000 nm and in 8 000 – 16 000 nm.

APPLICATION EXAMPLE: TWO PG511 FOR SFG PUMP PROBE

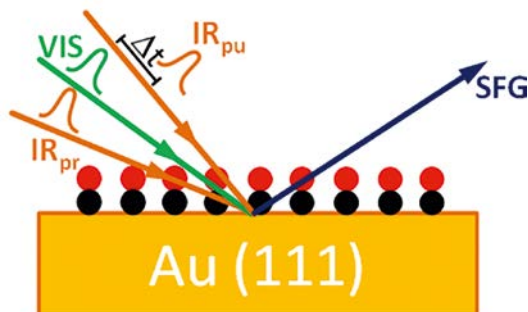

However, in some experiments one layer of the sample can be transparent only for VIS beam, but not for IR beam and vice versa. In such case experimental setup requires different geometries. This problem can be solved, if we can access interface from different sides, for example directing VIS beam from the top and IR beam from the bottom. Ekspla offers several standard geometries: top side, bottom side, top-bottom side and total internal reflection. All of them can be implemented in single spectroscopy unit and easy interchangeable.

The special design of SFG spectrometer provides possibility to change angles of interaction. This feature together with different polarization combinations helps better understand molecular dipoles orientation. In our spectrometer we use large aperture parabolic mirror. The sample is placed in focal point of parabolic mirror. Such solution makes optical system extremely simple in operation, because it guarantees the same beams position on the sample surface and perfect overlap, when incidence angle is changed.

Sample surface and beams overlap can be monitored using camera installed above sample area. This utility is integrated into every SFG spectrometer. On a special request sample visualization system can be combined with motorized beams adjustment. This allows to align SFG spectrometer from PC, even being physically far from it. It essentially solves safety issues and opens new possibilities for multiple long time experiments without accessing spectroscopy box.

SFG Spectrometer Accessories

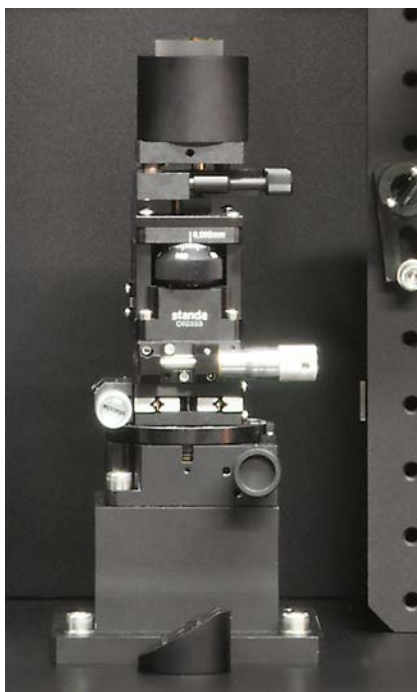

Compact and stable six axis manipulator for precise sample positioning.



SFG spectrometer with Langmuir trough used for studies of the unique properties of molecules in monolayers.



Hermetically sealed sample cell with heater, specially designed for SFG spectrometer, allows experiments under controlled environmental conditions.

OPTIONAL ACCESSORIES

- ▶ Six axis sample holder
- ▶ Sealed temperature controlled sample chamber
- ▶ Langmuir trough
- ▶ Motorisation of polarisation central of VIS beam, polarisation analyser

More detailed information about accessories for SFG spectrometers will be available soon. Please check Ekspla website: <http://www.ekspla.com/product/sfg-spectrometer>

Technical Specifications ¹⁾

Version	Classic	Advanced	Double Resonance	Phase Sensitive
SYSTEM (GENERAL)				
Spectral range	1000–4300 cm ⁻¹	625–4300 cm ⁻¹	1000–4300 cm ⁻¹	1000–4300 cm ⁻¹
Spectral resolution	< 6 cm ⁻¹ (optional: < 2 cm ⁻¹)		< 10 cm ⁻¹	< 6 cm ⁻¹ (optional: < 2 cm ⁻¹)
Spectra acquisition method	Scanning			
Sample illumination geometry	Top side, reflection (optional: bottom side, top-bottom side, total internal reflection)			
Incidence beams geometry	Co-propagating, non-collinear (optional: collinear)			non-collinear
Incidence angles	Fixed, VIS ~60 deg, IR ~55 deg (optional: tunable)			not tunable
VIS beam wavelength	532 nm (optional: 1064 nm)		Tunable 420–680 nm (optional: 210–680 nm)	532 nm
Polarization (VIS, IR, SFG)	Linear, selectable "s" or "p", purity >1:100			
Beam spot on the sample	Selectable, ~150–600 μm			Fixed
Sensitivity	Air-water spectra			Solid sample
PUMP LASERS ²⁾				
Model	PL2230		PL2230 for Double resonance	PL2230
Pulse energy stability	<0.5 %			
Pulse duration	28±3 ps			
Pulse duration stability	±1.0 ps			
Pulse repetition rate	50 Hz			
OPTICAL PARAMETRIC GENERATORS				
IR source with standard linewidth (<6 cm ⁻¹)	PG501-DFG1P	PG501-DFG2	PG501-DFG1P	
IR source with narrow linewidth (<2 cm ⁻¹)	PG511-DFG	PG511-DFG2	–	PG511-DFG
UV-VIS source for Double resonance SFG	–	–	PG401 (optional: PG401-SH)	–
<i>For standard specifications please check the brochure of particular model</i>				
PHYSICAL DIMENSIONS (FOOTPRINT)				
Standard	2400 × 1000 mm		3000 × 1500 mm	2600 × 1200 mm
Extended (with special options or large accessories)	2700 × 1200 mm		3000 × 1500 mm	2700 × 1200 mm

¹⁾ Due to continuous improvement, all specifications are subject to change without advance notice.

²⁾ Laser is optimised for pumping parametrical generator, maximum output energy may be different than specified for stand alone application.



Photo: SFG microscope – provides spectral and spatial surface information with micrometers resolution

Notes

A large grid of graph paper for taking notes, consisting of a 20x20 grid of squares.



ISO9001 Certified

TII 株式会社 東京インスツルメンツ
TOKYO INSTRUMENTS, INC.

本社：〒134-0088 東京都江戸川区西葛西 6-18-14 T. I. ビル
TEL：03-3686-4711 FAX：03-3686-0831

大阪営業所：〒532-0003 大阪市淀川区宮原 4-1-46 新大阪北ビル
TEL：06-6393-7411 FAX：06-6393-7055

Web：https://www.tokyoinst.co.jp/ E-mail：sales@tokyoinst.co.jp

Savanorių Av. 237
LT-02300 Vilnius
Lithuania

ph. +370 5 264 96 29
fax +370 5 264 18 09
sales@ekspla.com
www.ekspla.com