

Confocal Brillouin / Raman / Nanoindentation Combined System

Simultaneous Measurement of Mechanical and Chemical Properties through a Transparent Diamond Indenter

Igor Kudryashov^{1*}, Christian Budich¹, Dmitry Derevyanchuk¹ and Kenichi Kawamura¹; Alexey Useinov², Gulnaz Sultanova²
¹Tokyo Instruments, Inc. (*i_kudryashov@tokyoinst.co.jp); ²TISNCM

What is new ?

We introduce a combined indentation and Raman / Brillouin spectroscopy system to investigate local mechanical and chemical material properties under load with high spatial resolution.

The system is based on confocal Brillouin / Raman microscope Nanofinder®Flex 2 (Tokyo Instruments) in combination with the NanoScan (TISNCM) instrumented indentation module. Spectroscopy measurements are conducted in back-reflection geometry.

The target application of this device is visualizing the spatial distribution of mechanical properties (acoustic speed, elastic moduli, etc.) around the point of controlled load application.

The unique feature of the system is the utilization of a transparent Berkovich pyramid shaped diamond nano-indenter in order to measure the mechanical properties at loading condition in the vicinity of the point of load application by Brillouin / Raman spectroscopy.

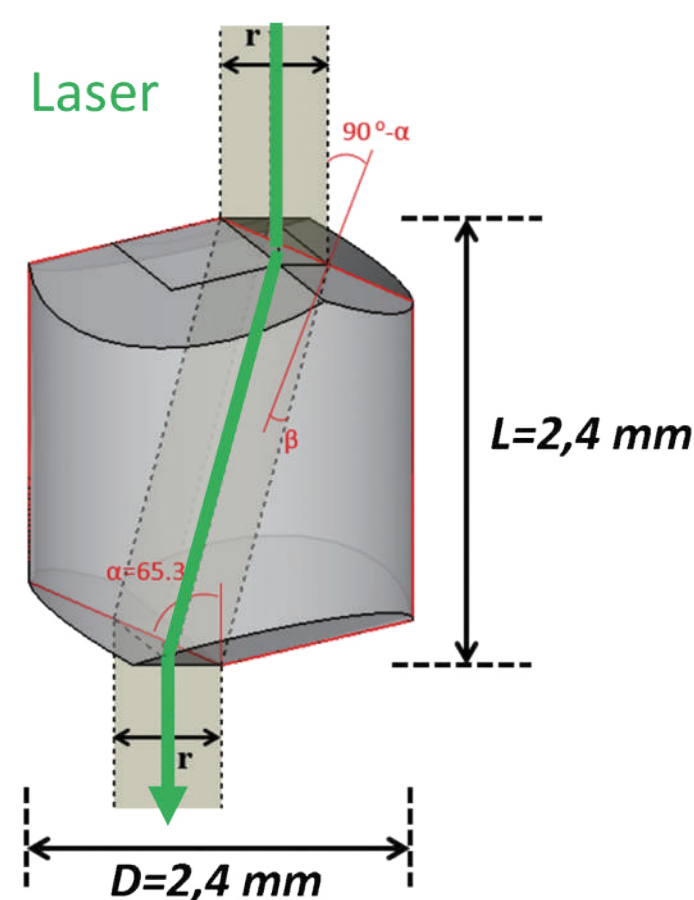

Berkovich pyramid shaped diamond nano-indenter

1. I.I. Maslenikov, V. N. Reshetov, A. S. Useinov, and M. A. Doronin
In Situ Surface Imaging Through a Transparent Diamond Tip
Instrum. Exp.Tech. 61, 719-724 (2018).
2. Reshetov V.N., Useinov A.S., Sultanova G.Kh., Kudryashov I.A., Budich K.
Application of an indenter-objective for optical spectroscopy of the structure and properties of materials. ChemChemTech [Izv. Vyssh. Uchebn. Zaved. Khim. Khim. Tekhnol.], 2021. V. 64. N 12. P. 34-40.
3. A. Useinov, V. Reshetov, A. Gusev, E. Gladkih
Optical spectroscopy combined in situ with instrumented indentation
Journal of Applied Physics 132, 121101 (2022) <https://doi.org/10.1063/5.0099166>

Combined Measurements

Indenting the surface of polystyrene changes the mechanical properties of the material. The transparent indenter allows spectroscopic measurements of these changes in situ.

The microscopic image (left) shows the surface of the loaded sample and the tip of the indenter. Spectral measurements were carried out at the points indicated.

Sample observation through the transparent indenter

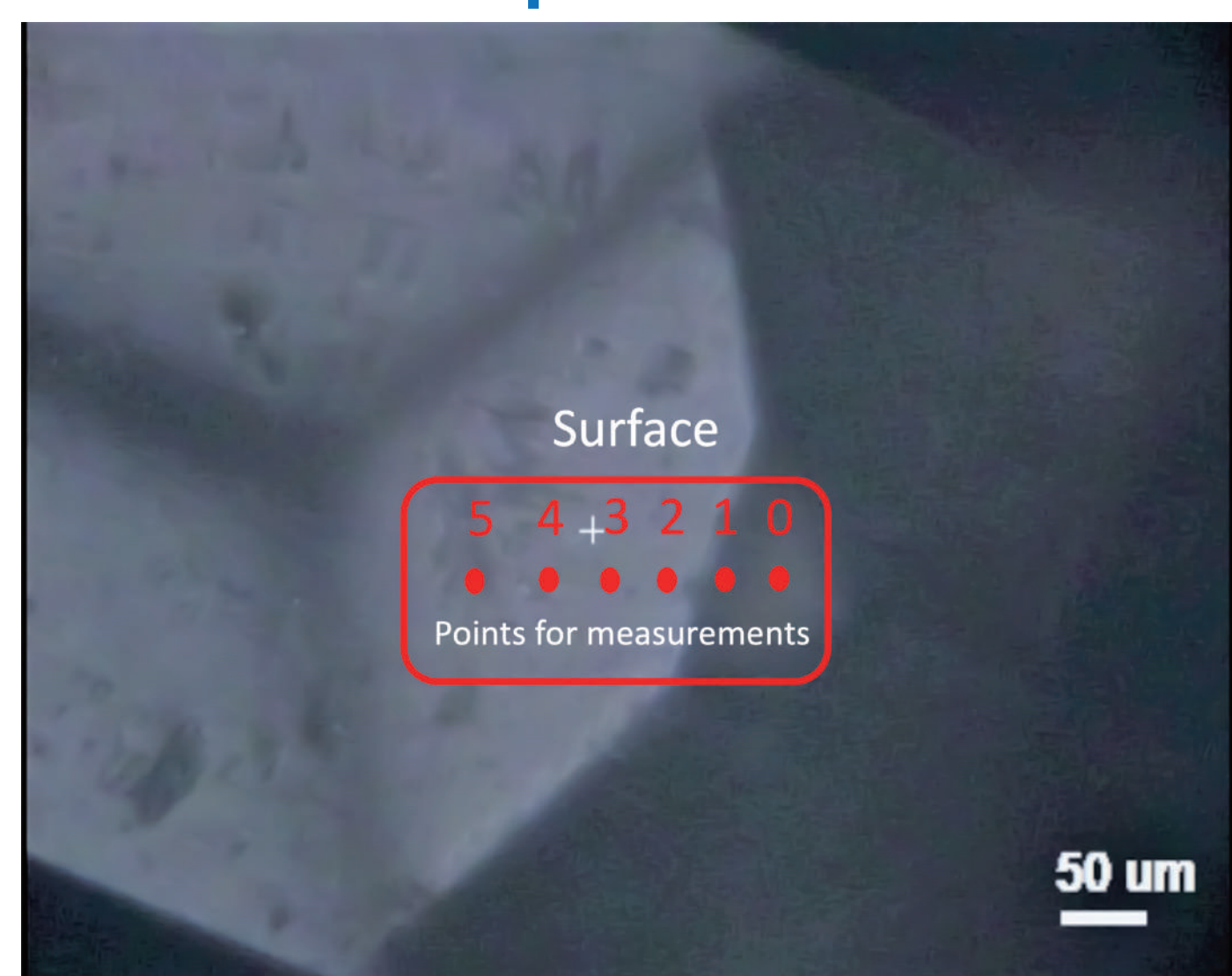

Brillouin spectra along the surface

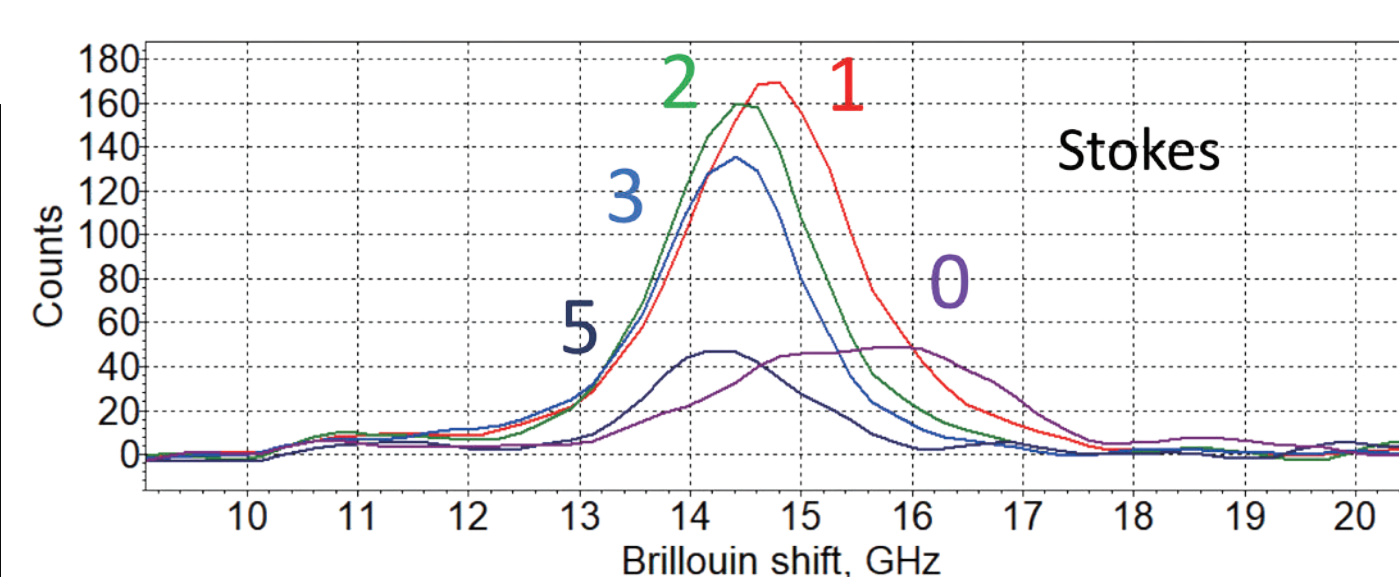

Measurements conditions

- Laser wavelength : 532 nm
- Microscope objective : 20X0.45 (effective 0.22) (with glass thickness correction)
- Laser power : 23 mW after objective
- Exposure time : 1 sec
- Pseudo-Voigt single curve fitting

Longitudinal elastic modulus spatial distribution, GPa

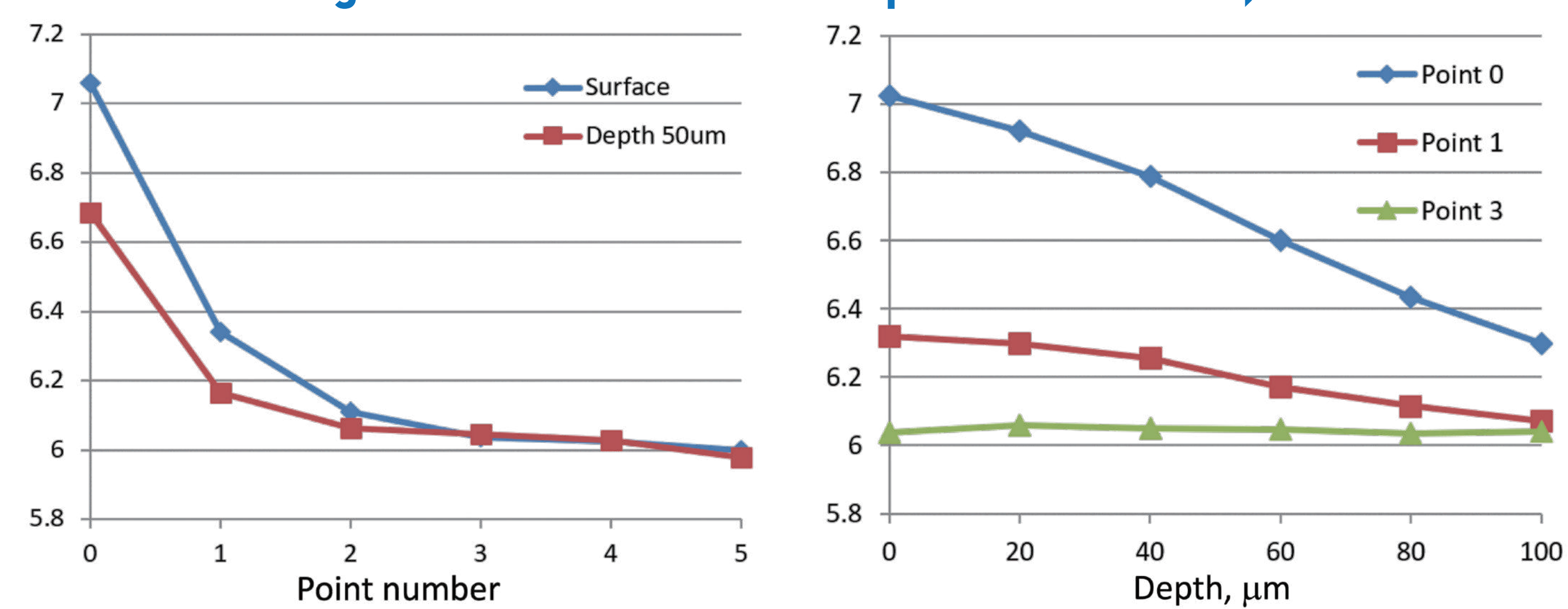

Brillouin spectra obtained from the loaded polystyrene sample across the indentation interface (right top) reveal systematic spectral changes when comparing the loaded region at the indenter apex (0) with the unloaded area (5).

The Brillouin line position allows the calculation of the longitudinal elastic modulus. It is clearly seen that material compression in the area under indenter load correlates with the increase in the value of the calculated elastic modulus.

- From Brillouin line shift position ν_B it is possible to calculate **longitudinal acoustic speed** V :

$$V = \frac{\nu_B \times \lambda_0}{2n}$$

where λ_0 – wavelength in vacuum, n – refractive index of the material ($n=1.599$ at 532 nm)

- From the longitudinal acoustic speed V we can calculate the **longitudinal modulus of elasticity** L (or P-wave modulus):

$$L = \rho \times V^2$$

where ρ – mass density of the material ($\rho= 1.06$ g/cm³)

- From Brillouin line FWHM $\Delta\nu_B$ it is possible to calculate **acoustic attenuation coefficient** α :

$$\alpha = \frac{\pi \Delta\nu_B}{V}$$

*Calculations were done in assumption of constant refractive index and density of material

Summary

The possibility of confocal Brillouin spectral imaging through a transparent diamond indenter around the point of controlled load in situ is shown. Brillouin imaging reveals the distribution of mechanical properties (elastic modulus), while simultaneous Raman imaging shows chemical properties (material identification) of the same sample area.

System and Components

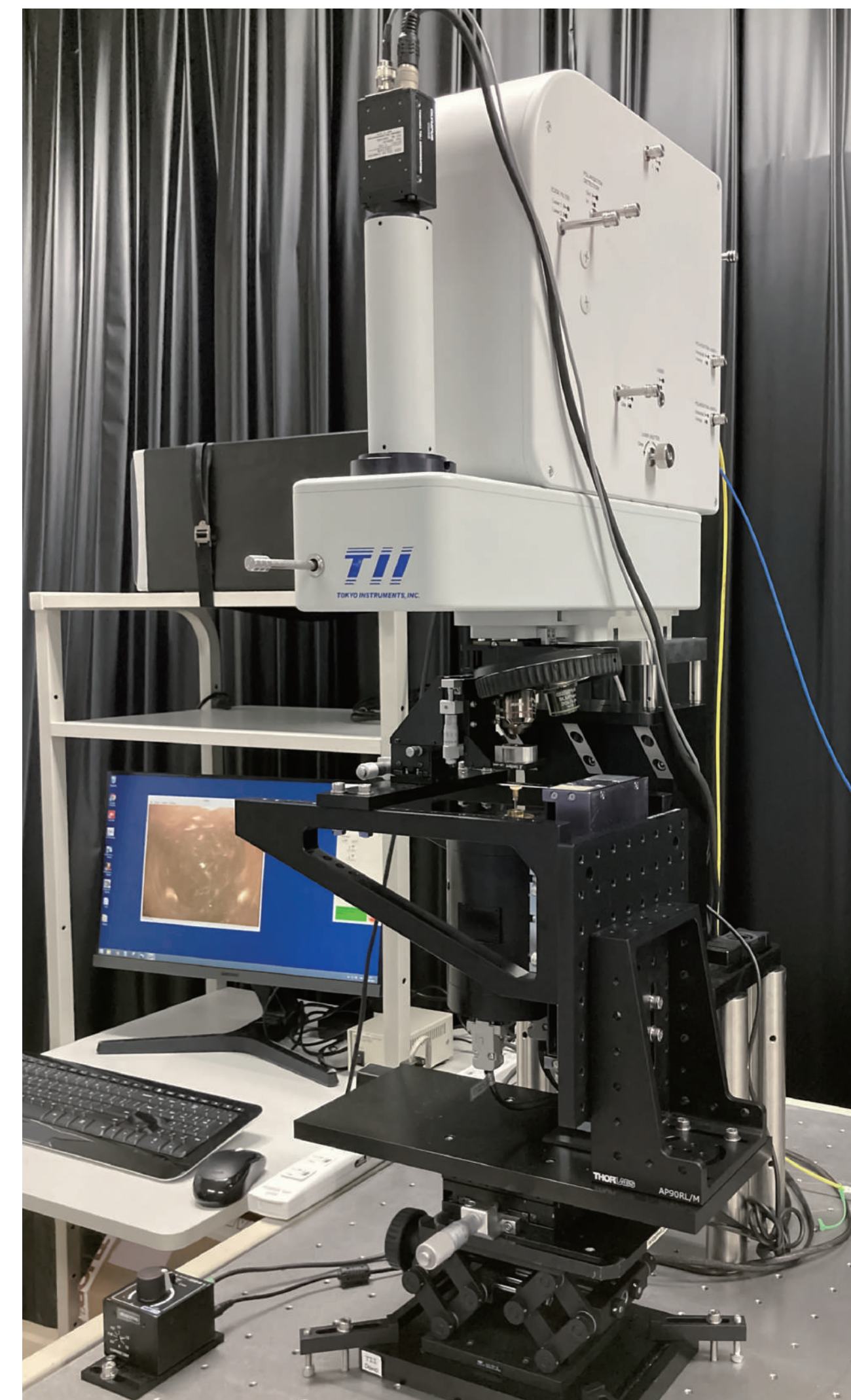

Brillouin HyperFine spectrometer with SMF input (LightMachinery)

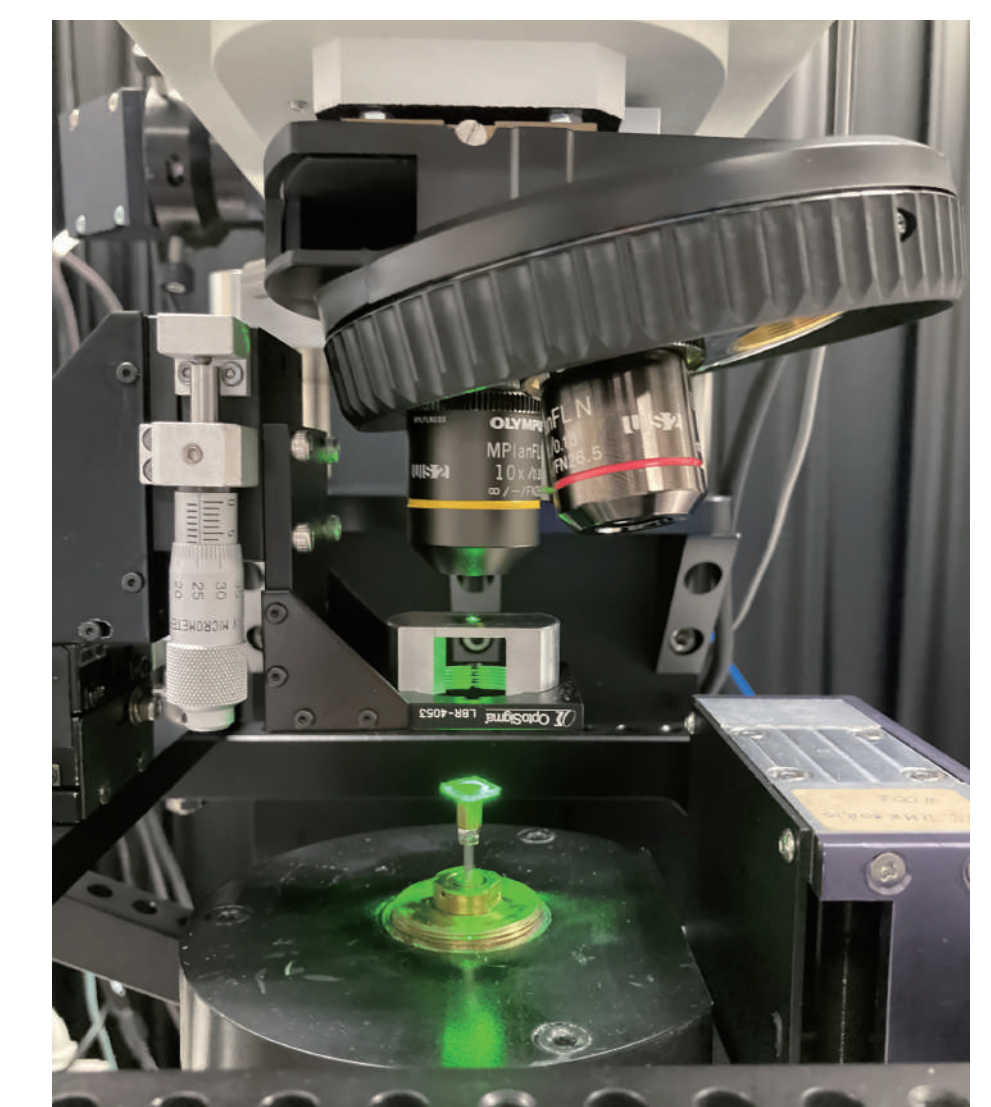

Confocal Brillouin/Raman Nanofinder®Flex 2 (Tokyo Instruments), combined with NanoScan indentation module (TISNCM)

Simultaneous Brillouin and Raman Imaging

Brillouin and Raman spectra in specific points

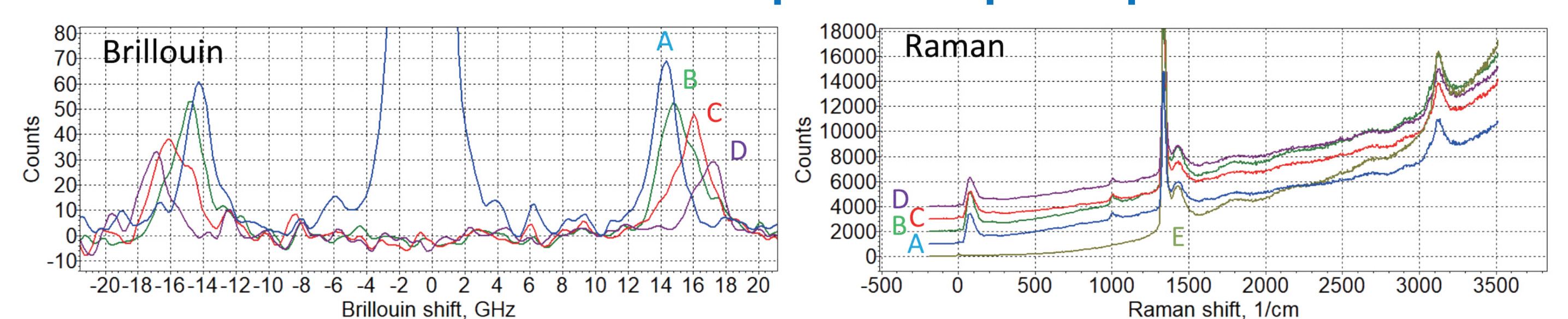

Brillouin imaging

The spatial distribution of mechanical properties of polystyrene under local load is shown. The Brillouin shift is related with the longitudinal elastic modulus and the Brillouin line width (FWHM) - with acoustic attenuation.

The triangular structure in the right corner represents the indented area under the tip.

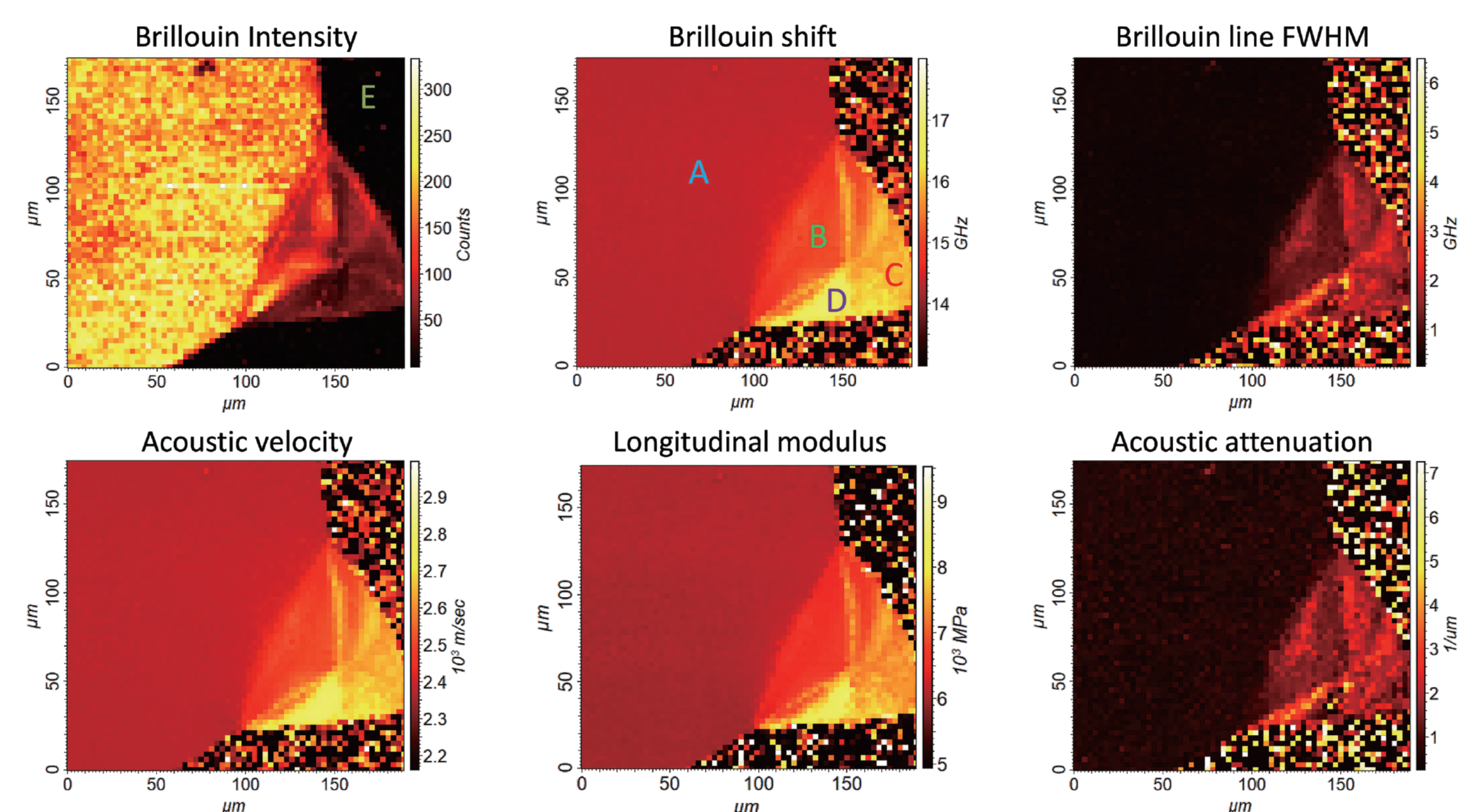

Raman imaging

Raman peak positions are associated with the chemical structure of the sample. Shown are the integrated peak intensities, related with polystyrene (sample, left), diamond (indenter, center) and broadband fluorescence (contamination of the indenter, right).

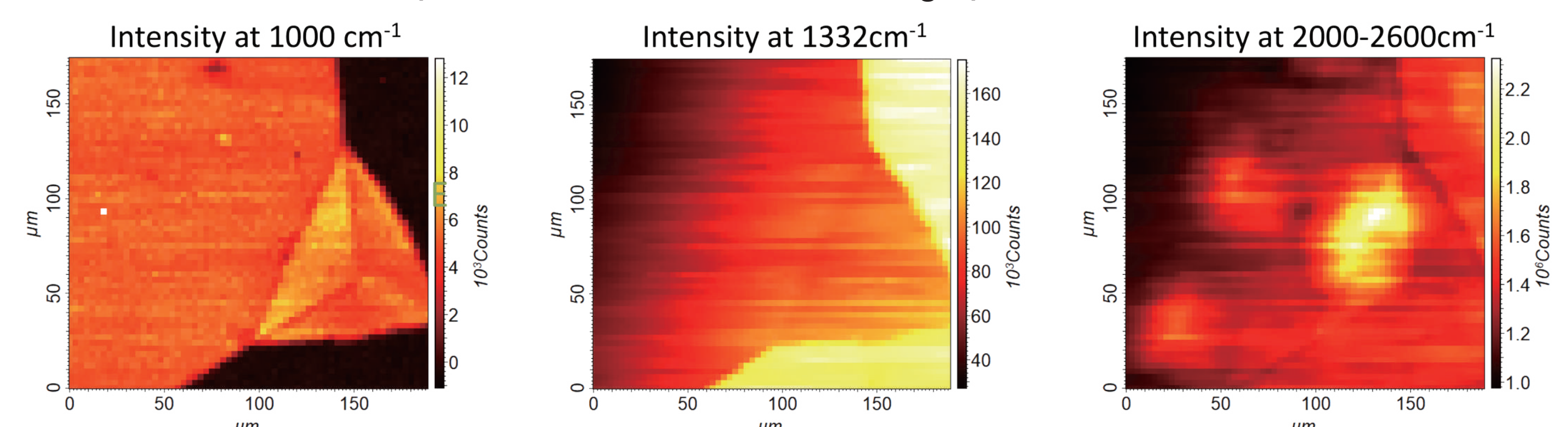

Measurements conditions

Sample loading 1N, Scanning is done by laser beam, Laser wavelength 532 nm, Microscope objective lens 10X0.25 (effective NA0.1), Laser power after objective lens 6 mW, Exposure time 1 sec/mapping point, 64x64 points, mapping step 3 mm, Lorentz single curve fitting / deconvolution