

User Guide

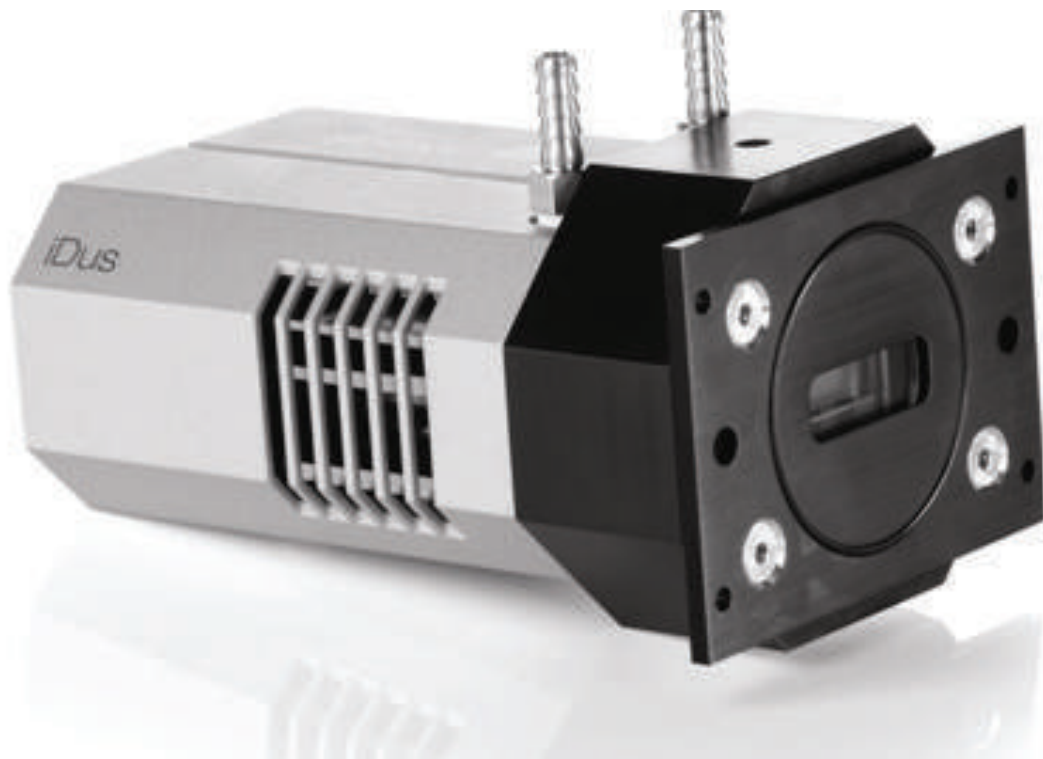

iDus

TABLE OF CONTENTS

SECTION 1 - ABOUT THE IDUS	12
1.1 INTRODUCTION	12
1.2 WORKING WITH THE USERS GUIDE	12
1.3 HELP	12
1.4 DISCLAIMER	13
1.5 TRADEMARKS & PATENT INFORMATION	13
1.6 TECHNICAL SUPPORT	14
Europe	14
USA	14
Asia-Pacific	14
China	14
1.7 COMPONENTS	15
1.7.1 Optional Extras	15
1.7.2 Camera	15
1.7.3 Power Supply Units	16
1.7.3.1 PS-24	16
1.7.3.2 PS-25	16
1.7.4 Software	16
1.7.5 Manuals	16
1.8 SAFETY PRECAUTIONS & SAFE CAMERA OPERATION	17
1.8.1 Care of the camera	17

1.8.2	Environmental conditions	17
1.8.3	Additional statement regarding equipment operation	17
1.8.4	Working with electronics	18
1.8.5	Head overheating	18
1.8.6	Cooling	19
1.8.6.1	Air cooling	20
1.8.6.2	Water cooling	20
1.8.6.3	Dew Point graph	21
1.8.6.4	Fan settings	21
SECTION 2 - INSTALLATION		22
2.1	COMPUTER REQUIREMENTS	22
2.2	INSTALLING THE SOFTWARE & USB DRIVER	22
2.3	INSTALLING THE HARDWARE	25
2.3.1	Connectors	25
2.3.2	System connection	26
2.3.3	New Hardware Wizard	26
2.3.4	Optional Spectrograph	28
2.3.5	Optional Mounting Flanges	28
SECTION 3 – USING THE IDUS		29
3.1	STARTING THE APPLICATION	29
3.2	MAIN WINDOW	30
3.3	HOT KEYS	32

SECTION 4 – PRE-ACQUISTION	34
4.1 SETTING TEMPERATURE	34
4.1.1 Fan Control	35
4.2 SETUP ACQUISITION	36
4.3 AUTO-SAVE	39
4.4 SPOOLING	40
SECTION 5 – ACQUIRING DATA	41
5.1 INITIAL ACQUISITION	41
5.2 DATA TYPE SELECTION	42
5.2.1 Definitions of data types	42
5.3 DATA FLIPPING	44
5.4 ACQUISITION TYPES	45
5.4.1 Autoscale Acquisition	45
5.4.2 Take Background	46
5.4.3 Take Reference	46
5.4.4 Acquisition Errors	46
5.5 ACQUISITION MODES & TIMINGS	47
5.5.1 Single Scan	47
5.5.2 Real Time	47
5.5.3 Accumulate	48
5.5.4 Kinetic Series & Accumulated Kinetic Series	48
5.6 TRIGGERING MODES	50

5.6.1	Internal	50
5.6.2	External	50
5.6.3	Fast External	50
5.6.4	External Start	50
5.7	SELECTING TRIGGER TYPE	51
5.8	READOUT MODES	52
5.8.1	Full Vertical Binning	53
5.8.2	Multi-track	54
5.8.3	Random Multi-track	56
5.8.4	Image	57
5.8.4.1	Image Orientation	57
5.8.5	Horizontal Pixel Shift Readout Rate	58
5.8.6	Vertical Pixel Shift Speed	58
5.9	TIMING PARAMETERS	59
5.10	SHUTTER	60
5.10.1	Time to open or close	63
5.10.2	Exposure Time	64
5.10.3	Accumulate Cycle Time & No. of Accumulations	64
5.10.4	Kinetic Series Length & Kinetic Cycle time	64
5.11	COSMIC RAYS	65
5.12	FILE INFORMATION	66
SECTION 6 - DISPLAYING DATA		67
6.1	DISPLAY MODES	67

6.2	DISPLAY PREFERENCES	68
6.3	AXIS DEFINITIONS	69
6.4	AXIS SETUP	70
6.5	ZOOM BOX	71
6.6	ZOOMING & SCROLLING	71
6.6.1	Zoom In & Zoom Out	71
6.6.2	Scrolling	71
6.6.3	Reset	72
6.7	2D DISPLAY MODE	72
6.7.1	2D display mode preferences	73
6.7.1.1	Peak Search	74
6.7.1.1.1	Peak Search Sensitivity	74
6.7.1.2	Peak Labeling	74
6.7.1.2.1	Labels on Peaks or Troughs	74
6.7.1.2.2	Maximum Number of Labeled Peaks	74
6.7.1.2.3	Format Labels	74
6.7.1.2.4	Weighted Peak	74
6.7.1.2.5	Pixel Peak	74
6.7.1.2.6	Label Peaks in all Overlaid Spectra	74
6.7.2	2D with Peak Labeling	75
6.7.3	Overlay	76
6.7.3.1	Overlay and Keep	79
6.7.3.2	Scale to Active	80
6.7.3.3	Remove Overlay	80

SECTION 6.7 (continued)

6.7.4	Baseline Correction	81
6.8	3D DISPLAY MODE	82
6.8.1	3D display mode preferences	83
6.9	IMAGE DISPLAY MODE	84
6.9.1	Image display mode preferences	85
6.9.1.1	Always maintain aspect ratio	85
6.9.1.2	Show 2D cross sections	86
6.9.1.3	Show palette bar	86
6.9.1.4	Large Cursor	87
6.9.2	Palette bar	87
6.9.3	Selecting Color/Grayscale	88
6.9.4	Rescale	90
6.9.5	High & Low Contrast Overview	92
6.9.5.1	Increasing & Decreasing Contrast	93
6.9.6	Brightness Overview	94
6.9.6.1	Adjusting Brightness	95
6.10	IMAGE & DISPLAY DATA RANGES SUMMARY	96
6.11	DATA HISTOGRAM	96
6.12	REGION OF INTEREST	98
6.12.1	ROI Counter	101

6.12.2	Hot Spot Approximation	101
6.12.3	Recalculate	101
6.12.4	Live Update	101
6.12.5	Maximum Scans	102
6.12.6	Plot Series	102
6.13	TIME STAMP	103
6.14	PLAYBACK	104
	SECTION 7 – HANDLING FILES	105
7.1	MENU OPTIONS	105
7.1.1	Open	105
7.1.2	Close	107
7.1.3	Save	107
7.1.4	Save As	107
7.1.5	Export As	108
7.1.5.1	ASCII	109
7.1.5.2	AVI	110
7.1.5.3	Bitmap	110
7.1.5.4	GRAMS	110
7.1.5.5	JPEG	111
7.1.5.6	MPEG	111
7.1.5.7	Raw Data	111
7.1.5.8	TIFF	113
7.1.5.9	Configuration Files	113
7.2	PROGRAM SELECTION	114

SECTION 8 - CALIBRATION	115
8.1 CALIBRATION OPTIONS	115
8.2 MANUAL X-CALIBRATION	116
8.2.1 Supplying Calibration Details	117
8.2.2 Applying Calibration	118
8.2.3 Calibrate	118
8.2.4 When Manual X-Calibration goes wrong	118
8.2.4.1 Data are Non-Monotonic	119
8.2.4.2 Too few points	120
8.2.5 Undo	120
8.2.6 Close	120
8.3 X-CALIBRATION BY SPECTROGRAPH	121
8.3.1 Setup Spectrograph	122
8.3.1.1 Calibrate As Red-Blue	122
8.3.2 Communications	123
8.3.2.1 Other Spectrographs	123
8.3.2.2 Reverse Spectrum	124
8.3.2.3 X-Axis Labels & Units	124
8.3.2.4 Change Units	125
8.3.3 Center Wavelength / Center of Raman Shift	126
8.3.3.1 Note on Raman Shift	126
8.3.4 Offset	127
8.3.5 Rayleigh Wavelength	127
8.3.6 Micrometer Setting	128

SECTION 8.3 (continued)

8.3.7	Grating	128
8.3.8	Close	128
8.3.9	Processing Data via the Command Line	129
8.3.9.1	Command Line	129
8.3.9.2	Calculations	129
8.3.9.3	Configure Calculations	129

SECTION 9 - WORKING WITH PROGRAMS 130**9.1 WORKING WITH ANDOR BASIC PROGRAMS 130**

9.1.1	Command Line	130
9.1.2	Program Editor Window	130
9.1.3	Accessing the Edit functions	131
9.1.4	Cut, Copy, Paste, Undo	131
9.1.5	Search	131
9.1.6	Replace	132
9.1.7	Run Program	133
9.1.8	Run Program by Filename	133
9.1.9	Entering Program Input	133

SECTION 10 - TUTORIAL 134**10.1 CALIBRATING DATA USING FLUORESCENT ROOM LIGHT 134**

10.1.2	Description	134
--------	-------------	-----

APPENDIX	136
A1.1 GLOSSARY	136
A1.1.1 CCD	136
A1.1.1.1 Readout Sequence of a CCD	137
A1.1.2 Accumulation	138
A1.1.3 Acquisition	138
A1.1.4 A/D Conversion	138
A1.1.5 Background	138
A1.1.6 Binning	138
A1.1.6.1 Vertical Binning	138
A1.1.6.2 Horizontal Binning (Creating Superpixels)	139
A1.1.7 Counts	140
A1.1.8 Dark Signal	140
A1.1.9 Detection Limit	141
A1.1.10 Exposure Time	141
A1.1.11 Frame Transfer	141
A1.1.12 Noise	142
A1.1.12.1 Pixel Noise	142
A1.1.12.1.1 Readout Noise	143
A1.1.12.1.2 Shot Noise	143
A1.1.12.1.3 Fixed Pattern Noise	143
A1.1.13 Pixel	144
A1.1.14 Quantum Efficiency / Spectral Response	144
A1.1.15 Readout	144
A1.1.16 Saturation	144
A1.1.17 Scan Types: Keep Clean & Acquired	144
A1.1.18 Signal to Noise Ratio	144
A1.2 MECHANICAL DIMENSIONS	145

A1.3	TERMS & CONDITIONS	146
A1.4	WARRANTIES & LIABILITY	147
A1.5	TERMS AND CONDITIONS OF SALE	148

SECTION 1 - ABOUT THE iDus

1.1 - INTRODUCTION

Thank you for choosing the Andor iDus. Andor's **CCD** (Charge Coupled Device) exploits the processing power of today's desk-top computers. USB 2.0 connectivity ensures a seamless interface with the camera, and also generates and receives signals you use to work with pulsed sources.

The system's hardware components and its comprehensive software provide speed and versatility that classical bench-top spectrometers cannot offer.

One can see, from the outset, that the iDus has been designed for ease of use. The camera is compact, requires no maintenance, and fits easily to popular spectrographs.

Under Solis software control, it serves as both a multi-channel detector and a linear image sensor, catering for a broad range of spectroscopic applications.

The rich functionality of the Solis package is described in detail in the remainder of this User's Guide.

1.2 - WORKING WITH THE USER'S GUIDE

This User's Guide is your 'road-map' to the Andor iDus software and hardware. With regard to the software, all the controls you need for an operation are grouped and sequenced appropriately in on-screen windows.

As far as possible, the descriptions in this User's Guide are laid out in sections that mirror the Windows Interface and use standard Windows terminology to describe the features of the user interface.

If you are unfamiliar with Windows, the documentation supplied with your Windows installation will give you a more comprehensive overview of the Windows environment.

1.3 - HELP

When the application is running, click the  Button or press **F1** on the keyboard and the Andor Solis Help dialog box will open. Click on the area for which you require help and you will be provided with information relevant to the part of the application for which you were seeking help.

In addition to the main On-Line Help, the system provides help that relates specifically to the **Andor Basic** programming language. If you are working in a Program Editor Window, context sensitive help is available on the 'reserved words' of the programming language. To activate, with the cursor on or immediately after a reserved word, press **Ctrl + F1**.

So, whenever you're working with a particular window, you'll find a section in the User's Guide that sets that window in context, reminding you how the window is launched, letting you know what it can do, and telling you what other windows and operations are associated with it.

We hope you find the use of our product rewarding. If you have any suggestions as to how our software, hardware and documentation might be improved, please let us know. You'll find the address of your nearest Andor representative on **page 16**. In addition, the software provides On-Line Help typical of Windows applications.

1.4 - DISCLAIMER

THE INFORMATION CONTAINED HEREIN IS PROVIDED “AS IS” WITHOUT WARRANTY, CONDITION OR REPRESENTATION OF ANY KIND, EITHER EXPRESS, IMPLIED, STATUTORY OR OTHERWISE, INCLUDING BUT NOT LIMITED TO, ANY WARRANTY OF MERCHANTABILITY, NON-INFRINGEMENT OR FITNESS FOR A PARTICULAR PURPOSE.

IN NO EVENT SHALL ANDOR BE LIABLE FOR ANY LOSS OR DAMAGE, WHETHER DIRECT, INDIRECT, SPECIAL, INCIDENTAL, CONSEQUENTIAL OR OTHERWISE HOWSOEVER CAUSED WHETHER ARISING IN CONTRACT TORT OR OTHERWISE, ARISING OUT OF OR IN CONNECTION WITH THE USE OF THE INFORMATION PROVIDED HEREIN.

COPYRIGHT AND PROTECTIVE NOTICES:

The copyright in this document and the associated drawings are the property of Andor Technology plc and all rights thereto are reserved. This document and the associated drawings are issued on condition that they are not copied, reprinted or reproduced, nor their contents disclosed in any form whatsoever.

The publication of information in this documentation does not imply freedom from any patent or proprietary right of Andor Technology plc or any third party.

1.5 - TRADEMARKS & PATENT INFORMATION

Andor, the Andor logo and iDus are trademarks of Andor Technology plc.

All other marks are property of their owners.

Changes are periodically made to the product and these will be incorporated into new additions of the manual.

1.6 - TECHNICAL SUPPORT

If you have any questions regarding the use of this equipment, please contact the representative* from whom your system was purchased or, alternatively, use one of the following addresses to contact us regarding your query:

Europe

Andor Technology plc
7 Millennium Way
Springvale Business Park
Belfast
BT12 7AL
Northern Ireland
Tel. +44 (0) 28 9023 7126
Fax. +44 (0) 28 9031 0792
www.andor.com/contact_us/support_request

USA

Andor Technology
425 Sullivan Avenue
Suite 3
South Windsor
CT 06074
USA
Tel. (860) 290-9211
Fax. (860) 290-9566
www.andor.com/contact_us/support_request

Asia-Pacific

Andor Technology (Japan)
4F NE Sarugakucho Building
2-7-6 Sarugaku-Cho
Chiyoda-Ku
Tokyo 101-0064
Japan
Tel. +81-3-3518 6488
Fax. +81-3-3518 6489
www.andor.com/contact_us/support_request

China

Andor Technology
Room 1213 Building B
Luo Ke Time Square
Chaoyang District
Beijing 100101
China
Tel. +86-10-5129-4977
Fax. +86-10-6445-5401
www.andor.com/contact_us/support_request

***NOTE: THE CONTACT DETAILS FOR YOUR NEAREST REPRESENTATIVE CAN BE FOUND ON OUR WEBSITE.**

1.7 - COMPONENTS

The main components of the Andor iDus system are as follows:

- Camera
- USB 2.0 compatible cable
- Power Supply Unit (PSU): PS-24 or for maximum cooling, optional PS-25
- Software in CD format

1.7.1 - Optional Extras

The following items can also be added to the system as necessary:

- Spectrograph
- Mounting Flanges
- Shutter & Shutter Driver SD-166

1.7.2 - Camera

The camera (**Figure 1**) contains the following items:

- CCD Sensor
- Pre-Amplifier & 16-bit analog to digital converter
- Cooling circuitry & Thermoelectric Cooler
- Input & output connectors.



Figure 1: iDus camera

NOTES:

1. The camera can be attached to a Spectrograph or other optical device for acquiring data.
2. The two water pipe connectors allow water to be passed through the head to assist cooling as required.

1.7.3 - Power Supply Units

1.7.3.1 - PS-24

The standard PS-24 PSU is fitted with an IEC connector for the electrical supply input. The connection to the iDus is made via a 5-pin DIN socket.



Figure 2: Standard PS-24 PSU

1.7.3.2 - PS-25

The optional PS-25 PSU can be used to achieve maximum cooling and has 2x settings; STANDARD COOLING or DEEP COOLING. The connection to the iDus is also made via a 5-pin DIN socket.



Figure 3: Optional PS-25 PSU

1.7.4 - Software

Software is supplied on a CD.

1.7.5 - Manuals

A full set of all Andor equipment manuals in CD format is supplied with each Andor CCD system.

1.8 - SAFETY PRECAUTIONS & SAFE CAMERA OPERATION

1.8.1 - Care of the camera

WARNINGS:

- 1. The camera is a precision scientific instrument containing fragile components. Always handle with the care necessary for such instruments.**
- 2. There are no user serviceable parts inside the camera. If the head is opened the warranty will be void.**
- 3. To prevent accidental internal damage to the camera, objects small enough to enter the slots on the sides of camera should be placed well away from these slots.**

1.8.2 - Environmental conditions

- 5Vdc with 15 Watts
- 7.5Vdc with 30 Watts (PS-25 only)
- ± 15 Vdc with 3Watts
- Indoor use only
- Altitudes up to 2000m
- Temperature 5°C to 40°C
- Maximum Relative Humidity 80% for temperatures up to 31°C, decreasing linearly to 50% relative humidity at 40°C
- Other voltage fluctuations as stated by the manufacturer
- Over voltage category 1
- Pollution Degree 2

1.8.3 - Additional statement regarding equipment operation

IF THE EQUIPMENT IS USED IN A MANNER NOT SPECIFIED BY ANDOR TECHNOLOGY PLC, THE PROTECTION PROVIDED BY THE EQUIPMENT MAY BE IMPAIRED.

1.8.4 - Working with electronics

The computer equipment that is to be used to operate the iDus should be fitted with appropriate surge/EMI/RFI protection on all power lines. Dedicated power lines or line isolation may be required for some extremely noisy sites. Appropriate static control procedures should be used during the installation of the system. Attention should be given to grounding. All cables should be fastened securely into place in order to provide a reliable connection and to prevent accidental disconnection.

The circuits used in the camera are extremely sensitive to static electricity and radiated electromagnetic fields, and therefore they should not be used, or stored, close to EMI/RFI generators, electrostatic field generators, electromagnetic or radioactive devices, or other similar sources of high energy fields. Types of equipment that can cause problems include the following:

- Arc welders
- Plasma sources
- Pulsed-discharge optical sources
- Radio frequency generators
- X-ray instruments

Operation of the system close to intense pulsed sources (lasers, xenon strobes, arc lamps, etc.) may also compromise performance, if shielding is inadequate.

1.8.5 - Head overheating

Care should be taken to ensure that the camera does not overheat, as this can cause system failure. Overheating may occur if either of the following situations arises:

- The air vents on the sides of the head are accidentally blocked or there is insufficient or no water flow.
- The ambient air temperature is more than 30°C.

To protect the camera from overheating, a thermal switch has been attached to the heat sink. If the temperature of the heat sink rises above a predefined limit, then the current supply to the cooler will cut out and a buzzer will sound. The cut-out will automatically reset once the head has cooled. It is not recommended that you operate in conditions that would cause repeated cut-outs as the thermal switch has a limited number of operations.

Please see next page for further information on Cooling.

1.8.6 - Cooling

The CCD detector is cooled using a thermoelectric (**TE**) cooler. TE coolers are small, electrically powered devices with no moving parts, making them reliable and convenient. A TE cooler is actually a heat pump, i.e. it achieves a temperature difference by transferring heat from its 'cold side' (the CCD-chip) to its 'hot side' (the built-in heat sink). Therefore the minimum absolute operating temperature of the CCD depends on the temperature of the heat sink. Our vacuum design means that we can achieve a maximum temperature difference of over 110°C (DU models with optional PS-25), a performance unrivalled by other systems. The maximum temperature difference that a TE device can attain is dependent on the following factors:

- Heat load created by the CCD
- Number of cooling stages of the TE cooler
- Operating current.

The heat that builds up on the heat sink must be removed and this can be achieved in one of two ways:

1. **Air cooling:** a small built-in fan forces air over the heat sink.
2. **Water cooling:** external water is circulated through the heat sink using the water connectors on the top of the head.

All Andor CCD systems support both cooling options. Whichever method is being used, it is not desirable for the operating temperature of the CCD detector simply to be dependant on or vary with the heat sink temperature. Therefore a temperature sensor on the CCD, combined with a feedback circuit that controls the operating current of the cooler, allows stabilisation of the CCD to any desired temperature within the cooler operating range.

As well as a choice of cooling method there is also a choice of performance versus compactness. This arises from the **Power Supply Unit** options that are available for supplying power to the temperature control circuit, i.e. the **PS-24 & PS-25** (optional for DU models only).

1.8.6.1 - Air cooling

Air cooling is the most convenient method of cooling, but it will not achieve as low an operating temperature as water cooling (see below). Even with a fan (see **NOTE** immediately below), a heat sink typically needs to be 10°C hotter than the air (room) temperature to transfer heat efficiently to the surrounding air. Therefore the minimum CCD temperature that can be achieved will be dependent on the room temperature.

NOTE: The fan does not operate until the heat sink temperature has reached between 20°C and 22°C. It is therefore quite normal for the fan not to operate when the system is first switched on. Please also see next page for information on fan settings.

1.8.6.2 - Water cooling

A flow of water through the heat sink removes heat very efficiently, since the heat sink is never more than 1°C hotter than the water. With this type of cooling, the minimum temperature of the CCD will be dependent only on the water temperature and not on the room temperature. For detailed performance figures please refer to **Table 1** below

Water cooling, either chilled through a refrigeration process or re-circulated (which is water forced air cooled then pumped), allows for lower minimum operating temperatures than air cooling. However, there is a very important point relating to water cooling. If the water temperature is lower than the dew point of the room, condensation will occur on the heat sink, the water taps and other metal parts of the head. This will quickly destroy the head and must never be allowed to happen. This is not an issue when using a Recirculator which eliminates the dew point problem.

NEVER USE COOLING WATER THAT IS COLDER THAN THE DEW POINT OF THE AIR IN THE ROOM. DAMAGE CAUSED IN THIS WAY IS NOT COVERED BY THE WARRANTY.

The table below is a guide to the minimum achievable operating temperatures for various room & water temperatures and performance of individual systems will vary slightly.

Table 1: Cooling performance

	DV MODEL PS-24 PSU PS-24 PSU	DU MODEL (STANDARD COOLING) PS-25 PSU	DU MODEL (DEEP COOLING) PS-25 PSU
Air-cooled (ambient air @ 20°C)	-55°C	-70°C	-80°C
Re-circulator (XW-RECR) (ambient air @ 20°C)	-65°C	-80°C	-95°C
Water-cooled (@ 10°C, 0.75 l / min)	-70°C	-85°C	-100°C

NOTES:

1. The relationship between the air temperature and the minimum CCD temperature in the table is not linear. This is because TE coolers become less efficient as they get colder.
2. Systems are specified in terms of the minimum dark current achievable, rather than absolute temperature. For dark current specifications, please refer to the specification sheet for your camera.

1.8.6.3 - Dew Point graph

The graph below plots the relationship between **Relative Humidity** and **Dew Point** at varying ambient temperatures. This can be used to calculate the minimum temperature the cooling water should be set to.

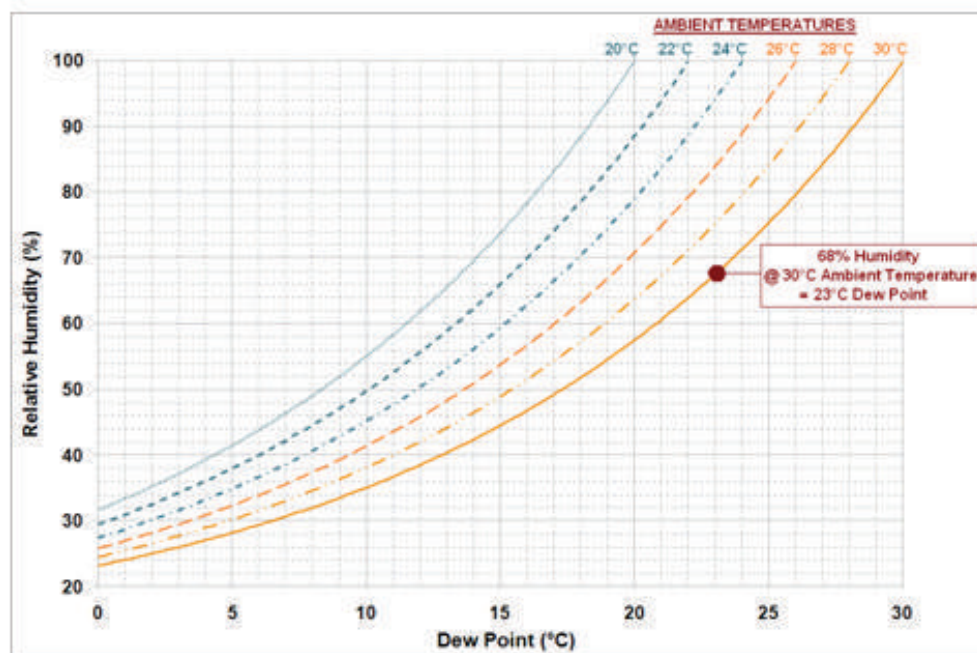

Figure 4: Dew point graph

For example, using a DU model & optional PS-25 you will need 10°C cooling water to guarantee performance down to -100°C. In the relatively dry atmosphere of an air-conditioned lab, cooling water at 10°C should not present any problems. However, in some humid conditions condensation may occur, resulting in damage to the head. In such conditions you will have to use warmer water (20°C or even higher if it is very humid). The minimum CCD temperature in this example would then be limited to between -90°C to -95°C.

1.8.6.4 - Fan settings

The speed of the cooling fan can also be controlled, which is useful if working in experimental configurations which are extremely sensitive to vibration. The vast majority of applications, including optical microscopy, can be used with the default highest fan speed, since the vibrations from the fan are minimal. However some applications can be extremely sensitive to even the smallest of vibrations (such as when combining an optical set-up with patch clamp electrophysiology or atomic force microscopy) and it can be useful to either select a slower fan speed, or to temporarily turn off the fan altogether for the duration of the acquisition.

If the fan is being turned off altogether, depending on the cooling temperature selected and on the ambient temperature, the acquisition duration can be as long as 15 - 20 minutes before temperature begins to rise. Then the fan must be turned on again to give the head time to re-stabilize (dissipate built-up excess heat from the Peltier TE cooler) before the next acquisition is begun.

NOTE: If water cooling is being used, the fan can be turned off and exceptional cooling performance maintained indefinitely.

SECTION 2 - INSTALLATION

2.1 - COMPUTER REQUIREMENTS

The minimum computer requirement to operate the iDus correctly is as follows:

- 800MHz Pentium Processor with 256MB RAM
- Windows 2000, XP or Vista
- USB 2.0 compatibility
- 25MB of free hard disc space

2.2 - INSTALLING THE SOFTWARE & USB DRIVER

1. Terminate & exit any programmes which are running on the PC.
2. Insert the Andor CD. The **InstallShield Wizard** now starts. If it does not start automatically, run the file **setup.exe** directly from the CD then follow the on-screen prompts that then appear, e.g.:

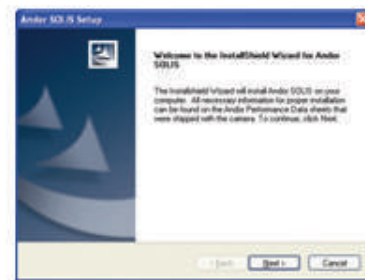

3. Click **Next >** and the following dialog box appears:

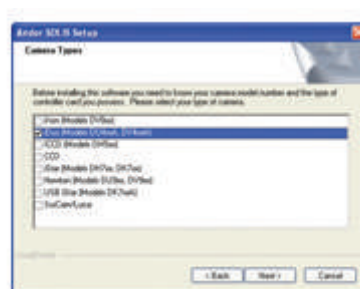

4. Tick the **iDus** selection as shown above then click **Next>** and the following dialog box appears:

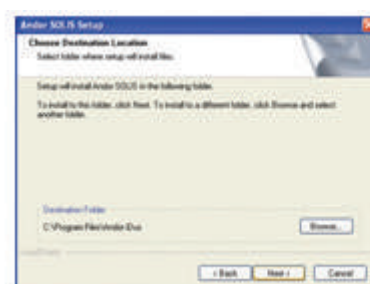

5. Click **Next >** (alternatively, click on **Browse...**, choose your own file destination then click **Next >**).

The following dialog box appears:

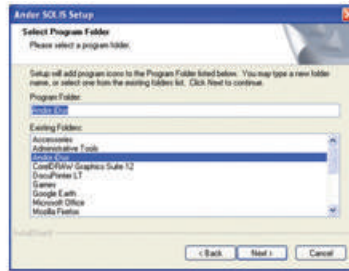

6. Select **Andor iDus** then click **Next >** again and the following dialog box appears:



7. Click **Next>** and an update progress bar will begin to appear, e.g.:

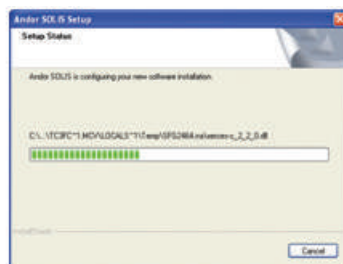

8. When the update progress bar stops, the following dialog box appears:

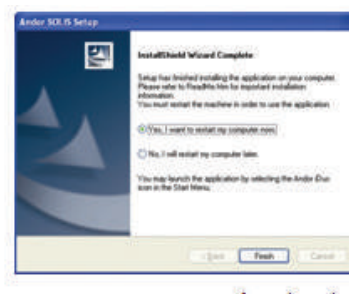

9. Select the **'Yes, I want to restart my computer now'** option then click **Finish**.

10. A message similar to the following may appear:

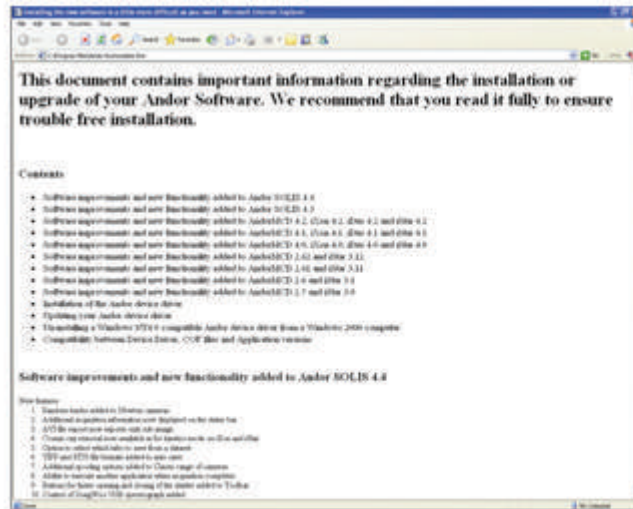

11. Please read the message and observe any important information relevant to your system. Restart the PC if required.

After the PC has been restarted, the  icon should now be installed on your desktop. Click on this to start the application.

2.3 - INSTALLING THE HARDWARE

2.3.1 - Connectors

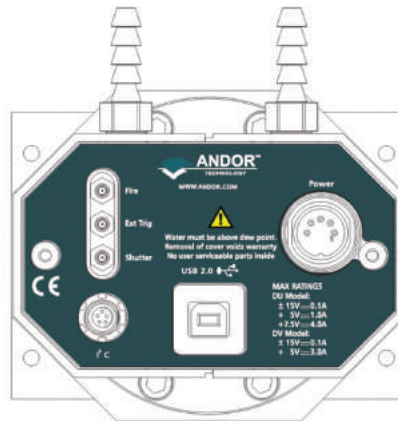

Figure 4: iDus connection points

There are 6 connection points on the rear of the iDus as shown above. Three of the connection points are industry-standard SMB (Sub Miniature B) connectors labelled from top to bottom as follows:

- **Fire**
- **Ext Trig**
- **Shutter**

These are used to send or receive Triggering and Firing signals, which are described later in this manual. The SMB outputs (**Fire & Shutter**) are CMOS compatible & Series terminated at source (i.e. in the camera head) for 50Ω cable.

NOTE: The termination at the customer end should be high impedance (not 50Ω) as an incorrect impedance match could cause errors with timing and triggering. The SMB Ext Trig input is TTL level & CMOS compatible and has 470Ω impedance.

The other connection points are as follows:

- **USB 2.0:** a USB 2.0 compatible cable can be connected between the USB socket and a PC.
- **I²C:** Philips™ introduced the I²C™ bus 20 years ago and today it is the de facto standard for controlling and monitoring applications in computing, communications and industrial segments. The pin connections for the five-way I²C connector used on the iDus are shown below:

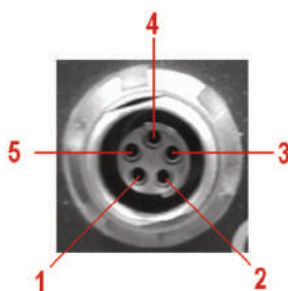

PIN	FUNCTION
1	SHUTTER (TTL)
2	I2C CLOCK
3	I2C DATA
4	+5V
5	GROUND

FISCHER CLIC-LOC™

Figure 5: I2C connection (facing in) with pin-outs

- **Power:** A 5-pin DIN plug is fitted for power connection

2.3.2 - System connection

Connect the elements of your system in the sequence that follows:

- Power up the PC
- Connect the PS-24 or PS-25 supplied to the **Power** connection point on the rear of the camera (please refer to **figure 5** on the previous page)
- Connect the USB cable between the connection point on the rear of the camera (again, please refer to **figure 5** on the previous page) and any available USB 2.0 port on the PC

2.3.3 - New Hardware Wizard

When the camera is first connected, the following screen may appear:

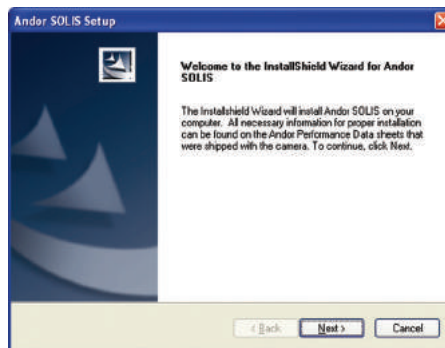

1. Select the 'Yes, this time only option' then click **Next>** and the following screen appears:

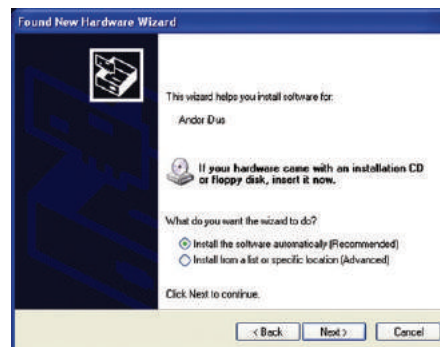

2. Select the 'Install the software automatically (Recommended)' option then click **Next>**. The following screens appear:

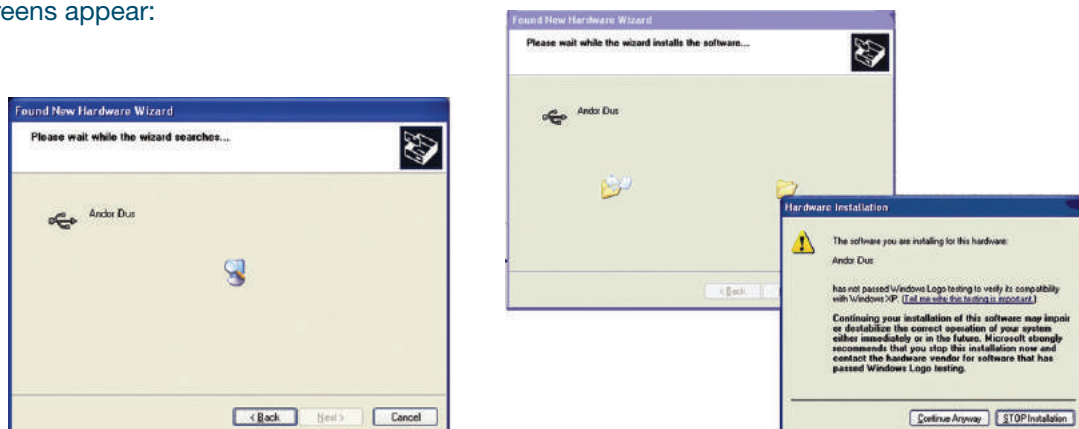

3. Click the **Continue Anyway** button. The software will continue to be installed, e.g.:

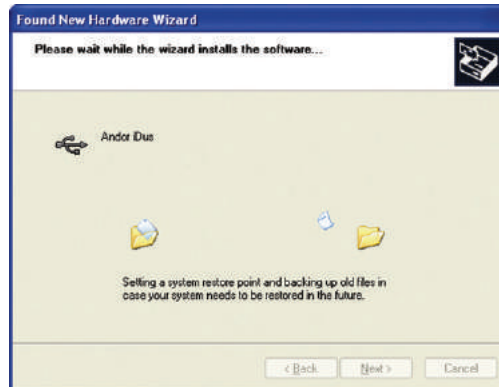

4. When the installation is complete, the following dialog box appears:



5. Click **Finish** to complete the install.

2.3.4 - Optional Spectrograph

A Spectrograph is usually required for spectroscopic measurements. A spectrograph and CCD combination (an optical spectral analyzer) may be used to replace the traditional motor-driven monochromator and photomultiplier tube. In a spectrograph, a wide aperture replaces the exit slit found in the monochromator. The spectrograph causes a dispersed spectrum to be projected, as a continuous band of wavelengths, on to a CCD at the focal plane.

In order that the camera can be positioned at the focal plane, the correct mounting flange must be attached to the spectrograph. In addition, you must ensure that an appropriate entry slit and grating are used for the particular spectral analysis you want to undertake.

2.3.5 - Optional Mounting Flanges

Mounting Flanges (or face plates) are metal plates which allow the camera to be positioned at the focal plane of a spectrograph.

Andor can provide mounting flanges for a wide range of spectrographs, in imaging and non-imaging format, with focal lengths ranging from 125cm to 1m if required.

Please consult your spectrograph instruction manual to ensure that you are using the correct flange.

SECTION 3 – USING THE iDus

3.1 - STARTING THE APPLICATION

On the desktop, click on the  icon and the **Solis Splash Screen** will briefly appear, e.g.:





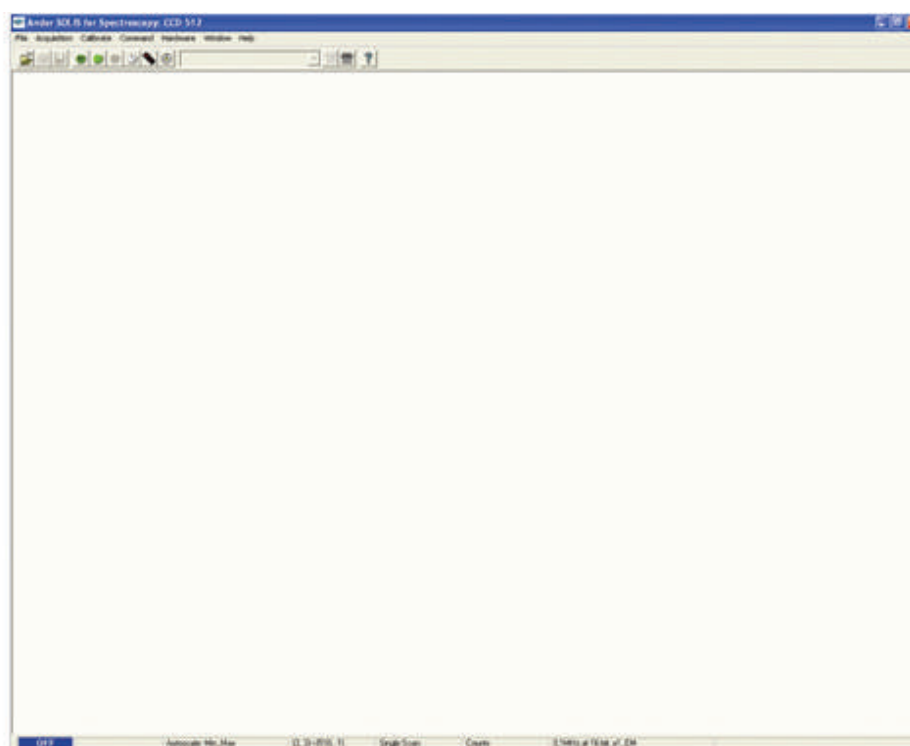





























The **Main Window** then appears, e.g.:



3.2 - MAIN WINDOW

The Main Window is your “entry point” to the system. Menu options allow you to select execute functions directly or by launching further windows dialog boxes. These windows dialog boxes then enable you to select the functionality that you may require. Some menu options on the Main Window are also represented as easy-to-use radio buttons, as shown in Table 2 below:

Table 2: Main Window buttons

ICON	TITLE	ICON	TITLE	ICON	TITLE
	Open		Help		Image Display mode
	Print		Select Autoscale Area (Not Used)		Change False Color Palette
	Save		Reset		Time Stamp
	Real Time		Rescale		Play
	Take Signal		Acquisition Autoscale #0		Pause
	Abort Acquisition		Data Histogram		Stop
	Setup Acquisition		Region Of Interest		Playback Autoscale - Off
	Run-Time Control		File Information		Baseline Correction
	Shutter		2D Display mode with Peak Labels		Periodic Table
	Run Program		2D Display mode		Temperature Control - Off
	Command Line		3D Display mode		Temperature Control - On

NOTE: Some menu titles and buttons appear on the main window only under certain circumstances as shown on the next page.

- The Display menu and its associated buttons will not appear until you open a Data Window, e.g.:

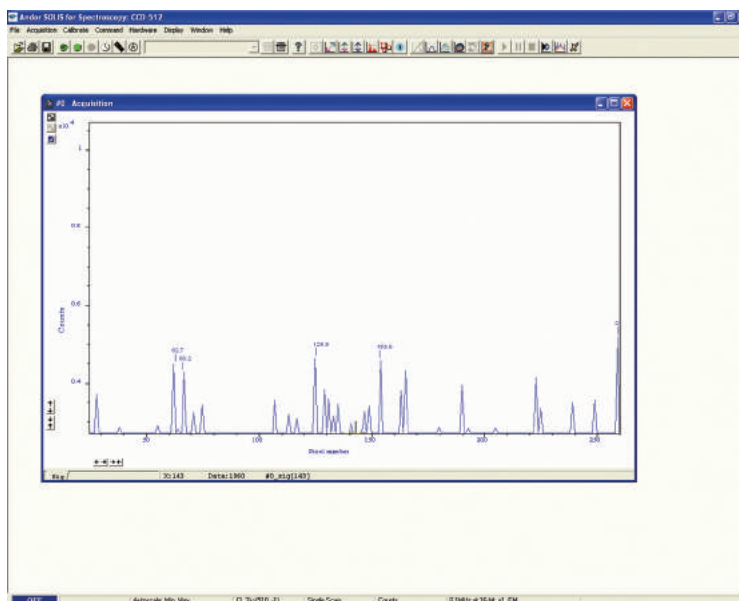

- The Edit & Search menus and their associated buttons appear only when a Program Editor Window is active, e.g.:

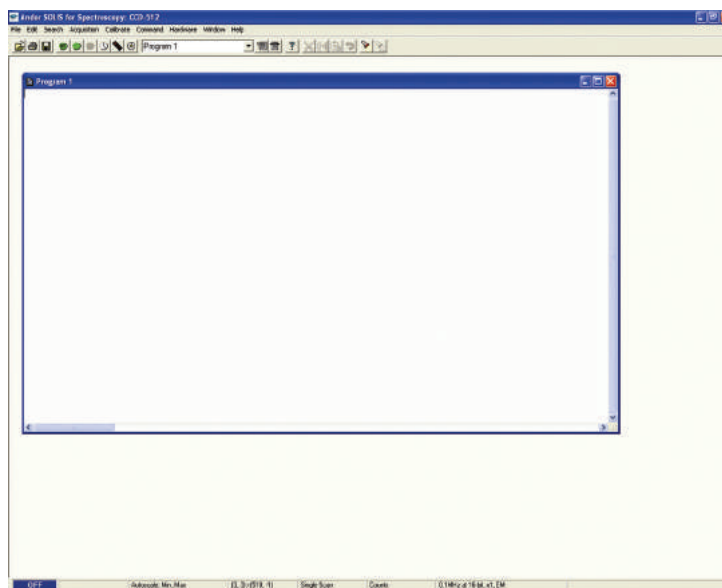

3.3 - HOT KEYS

Hot keys (or shortcuts) as shown in Tables 3, 4 & 5 (this page and the next) enable you to work with the system directly from the keyboard, rather than via the mouse.

Table 3: Data Acquisition Hot Keys

KEY STROKE(S)	DESCRIPTION
F5	Take signal
F6	Autoscale Acquisition
Ctrl + B	Take background
Ctrl + R	Take reference
Esc	Abort Acquisition

Table 4: Data Window Hot Keys

Key strokes	Description	Display mode		
		2D	3D	Image
+	Expand ('Stretch') data-axis	✓	✓	✓
-	Contract ('Shrink') data-axis	✓	✓	✓
Ins	If maintain aspect ratio off, expand x-axis. If maintain aspect ratio on, expand x-axis and y-axis	✓	✓	✓
Del	If maintain aspect ratio off, contract x-axis. If maintain aspect ratio on, contract x-axis and y-axis.	✓	✓	✓
/	On image, if maintain aspect ratio off, expand y-axis. On image, if maintain aspect ratio on, expand x-axis and y-axis.			✓
Home	Move cursor furthest left	✓	✓	✓
End	Move cursor furthest right	✓	✓	✓
PgUp	Scroll up through tracks	✓	✓	✓
PgDn	Scroll down through tracks	✓	✓	✓
Shift + PgUp	Move to next image in series	✓	✓	✓
Shift + PgDn	Move to previous image in series	✓	✓	✓
Left Arrow	Move cursor left	✓	✓	✓
Right Arrow	Move cursor right	✓	✓	✓
Up Arrow	Scroll trace up (on image: move cursor up)	✓	✓	✓
Down Arrow	Scroll trace down (on image: move cursor down)	✓	✓	✓
Shift + Left Arrow	Scroll trace/image left	✓	✓	✓
Shift + Right Arrow	Scroll trace/image right	✓	✓	✓
Ctrl + Left Arrow	Peak search left	✓	✓	✓
Ctrl + Right Arrow	Peak search right	✓	✓	✓
F7	Toggle Palette	✓	✓	✓
F8	Reset	✓	✓	✓
F9	Rescale	✓	✓	✓
Alt + F9	Toggle Rescale Mode	✓	✓	✓
Ctrl + F9	Scale to Active (Please see Displaying Data section)	✓	✓	✓
F10	File information	✓	✓	✓

Table 5: Andor Basic Programming Language Hot Keys

KEY STROKE(S)	DESCRIPTION
Ctrl + N	New program
Ctrl + E	Run program
Esc	Abort acquisition / program
Ctrl + L	Command line
Ctrl + F1	Context sensitive help on reserved words in the Andor Basic programming language is available if you are using the Program Editor Window.

SECTION 4 – PRE-ACQUISITION

4.1 - SETTING TEMPERATURE

For accurate readings, the CCD should first be cooled, as this will help reduce dark signal and associated shot noise. To do this, either select the Temperature option from the Hardware drop-down menu on the Main Window:



or click the **OFF** button in the bottom-left of the screen

This will open up the **Temperature** dialog box :

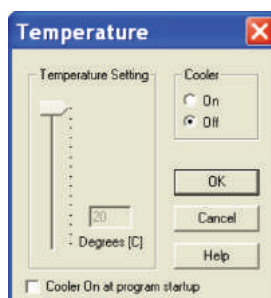

Select **On** in the **Cooler** check box.

The Degrees (C) field in the **Temperature Setting** section will now be highlighted in blue and the **Cooler** will be indicated as **On**, e.g.:

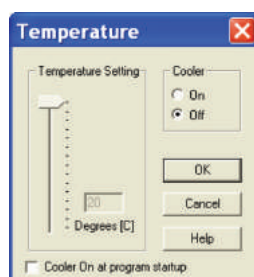

To adjust the temperature, either type in the new figure in the **Degrees (C)** box or move the slider bar down or up. Once the desired temperature has been selected, click OK. The dialog box will disappear and the Temperature Control button in the bottom-left of the screen will show the current temperature highlighted in red e.g.: **-45°C**

This figure will change as the head cools. Once the head has reached the desired temperature, the highlighted area changes to blue.

You can also select the option to have the Cooler switched on as soon as you start the application. This is selectable in the bottom-left of the Temperature dialog box.

PLEASE REFER TO PAGES 22 - 24 FOR DETAILS OF MINIMUM ACHIEVABLE TEMPERATURES, AND IMPORTANT ADVICE ON AVOIDING OVERHEATING.

4.1.1 - Fan Control

The speed of the cooling fan can also be controlled. Select **Fan Control** from the **Hardware** drop-down menu as shown:

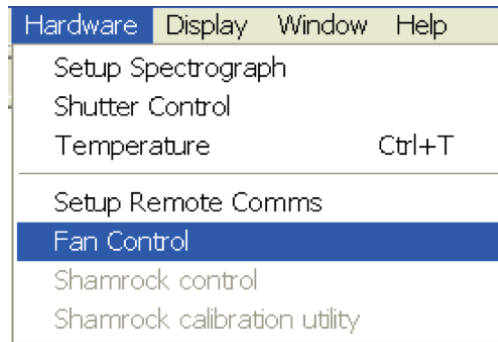

The Fan speed dialog box will appear:

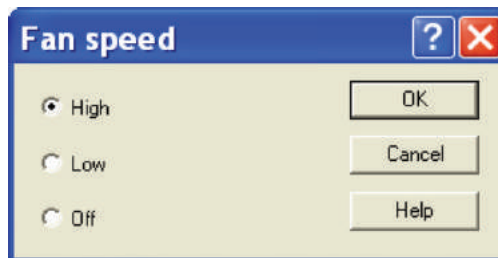

Select the speed you require (this may affect the cooling ability of the CCD).

NOTE: After changing from High to Low, it may be necessary for the camera temp to stabilize before acquiring data. However for optimum performance it is recommended to leave the fan setting at High.

4.2 - SETUP ACQUISITION

To select the mode of acquisition prior to data capture, you can carry out one of the following actions:

- Click the  button
- Key in **Ctrl+A** from the keyboard
- Select **Setup Acquisition** from the **Acquisition** drop-down menu:

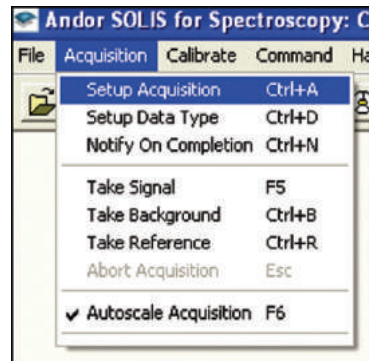

The **Setup Acquisition** dialog box appears, e.g.:

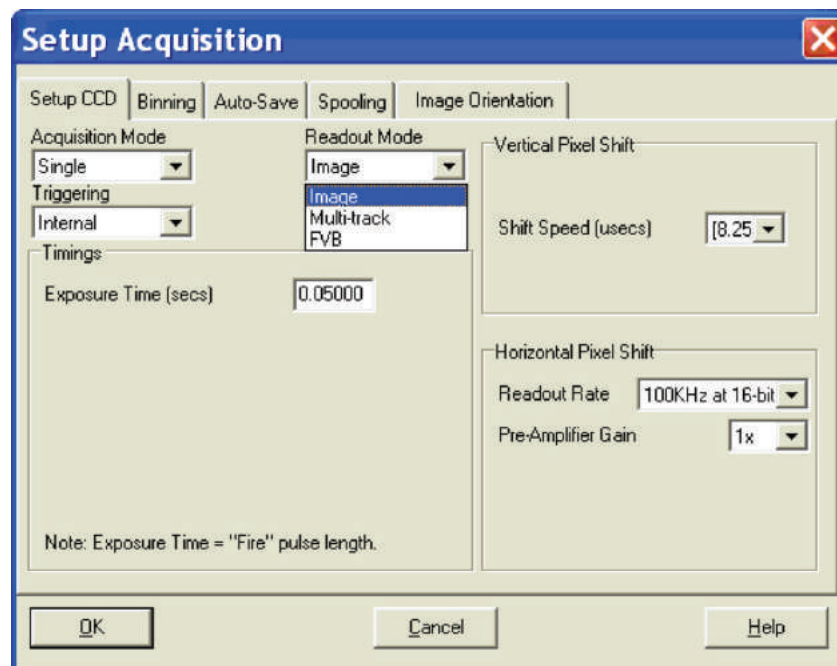

The following options are available in the Setup **CCD** area:

ACQUISITION MODE

- Single
- Accumulate
- Kinetic

TRIGGERING

- Internal
- External
- External Start (Accumulate, & Kinetic modes only)
- Fast External

READOUT MODE

- Image
- Multi-Track
- FVB (Full Vertical Binning)

VERTICAL PIXEL SHIFT SPEED

- (4.25) μ secs
- (8.25) μ secs
- 16.25 μ secs
- 32.35 μ secs
- 64.25 μ secs

HORIZONTAL PIXEL SHIFT READOUT RATE

- 33KHz at 16-bit
- 50KHz at 16-bit
- 100KHz at 16-bit

HORIZONTAL PIXEL SHIFT PRE-AMPLIFIER GAIN

- x1
- x1.7

The **Horizontal Pixel Shift Pre-Amplifier Gain** can be set as required for either lowest possible noise or maximum dynamic range. Depending on which combination of Acquisition, Readout & Triggering modes are selected, other additional Timings options become available.

Table 6 on the next page lists the parameters for which you may enter a value in the appropriate text box. As you select an Acquisition Mode you will notice that you are able to enter additional exposure-related and timing parameters in a column of text boxes.

Certain text boxes become active as you select each Acquisition Mode. Minimum default values are also shown in the text boxes. **NOTE: The value you enter in one text box may affect the minimum permissible value in another text box. The system updates the display of minimum permissible values accordingly.**

Table 6: Acquisition modes

Acquisition Mode (Readout Mode)	Exposure Time (secs)	No. of Accumulations	Accumulate Cycle Time (secs) (Internal Triggering)	Kinetic Series Length	Cosmic Ray Removal	Kinetic Cycle Time (secs)
Single (Image)	✓					
Single (FVB)	✓					
Accumulate (Image)	✓	✓	✓		✓	
Accumulate (FVB)	✓	✓	✓		✓	
Kinetic (Image)	✓			✓		✓
Kinetic (FVB)	✓			✓		✓

Acquisition Mode (Readout Mode)	Exposure Time (secs)	Sub-area Height	Number Of series	Binning	Offset from bottom row
Fast Kinetic (Image or FVB)	✓	✓	✓	✓	✓

4.3 - AUTO-SAVE

Auto-Save allows you to set parameters and controls for the auto saving of acquisition files, thus removing the worry of losing data and files. To select, click on the **Auto-Save** tab on the Setup Acquisition dialog box and the Auto-Save window appears, e.g.:

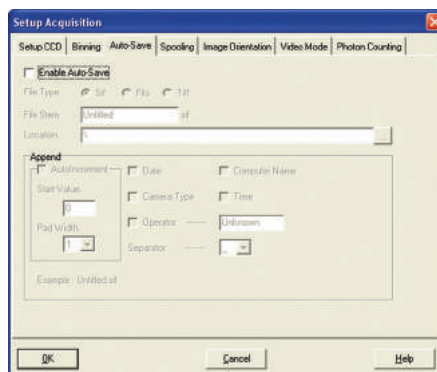

Tick the **Enable Auto-Save** box. If selected, acquisitions will be saved automatically when each one is completed. Each subsequent auto-saved file will overwrite the previously auto-saved one.

There is also an **Auto-Increment On/Off** tick box. This allows a number to also be appended to the main Stem Name. This number is automatically incremented each time a file is saved. This time the auto-saved files will not overwrite any previous auto-saved files. In the Auto-Save dialog box, a Stem Name may be entered. This is the main root of the name that the acquisition is to be saved as, e.g.:

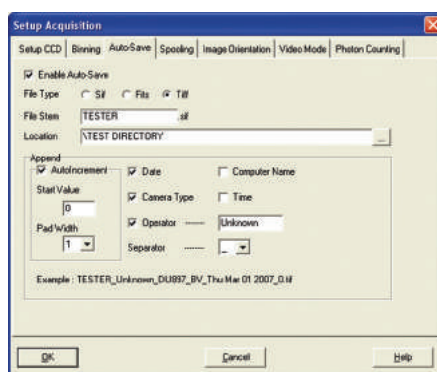

The Stem Name can be appended with a number of details as follows:

- **Date**
- **Computer name**
- **Camera type**
- **Time**
- **Operator name (supplied by user)**
- **Separator**

Any combination of these may be selected by activating the relevant tick box.

NOTE: This function will only **Auto-Save Single Scan, Kinetic Series, Fast Kinetics or Accumulated images, not data acquired in Video mode.**

4.4 - SPOOLING

The Andor Solis software allows you to spool acquisition data directly to the hard disk of your PC. This is particularly useful when acquiring a series of many images. The amount of data generated by a Kinetic Series of, for example 1000 acquisitions, is huge and more than most PC RAM can handle.

To select, click on the **Spooling** tab and the **Spooling** dialog box appears e.g.:

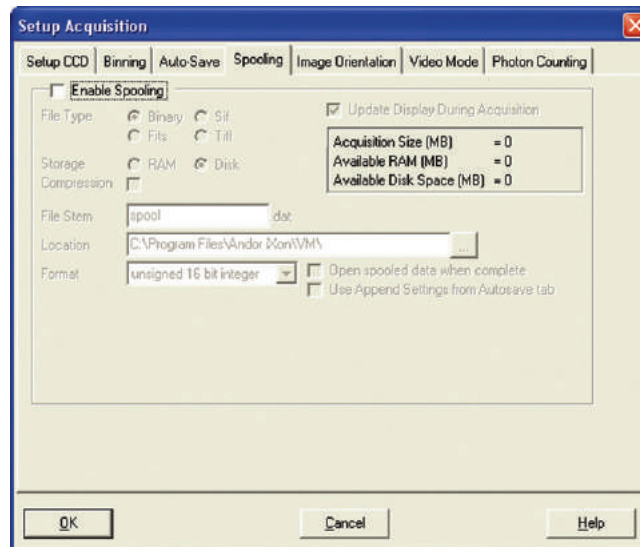

With the spooling function enabled, data is written directly to the hard disk of you PC, as it is being acquired. To enable the spooling function on your software, tick the **Enable Spooling** box. You must also enter a stem name, and also select a location for the for this spooled data file, e.g.:

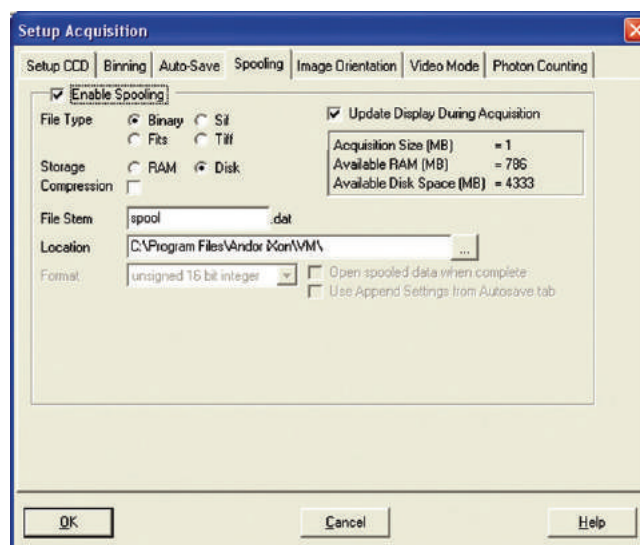

NOTE: Spooling large amounts of data straight to hard disk for later retrieval, requires a hard disk of sufficient read-write speed. Andor recommends only very high-speed hard disk drives be used for this type of operation.

SECTION 5 - ACQUIRING DATA

5.1 - INITIAL ACQUISITION

To start an initial data acquisition you can, click the  button on the Main Window, press F5 on the keyboard or select the Take Signal option from the Acquisition drop-down menu as shown:

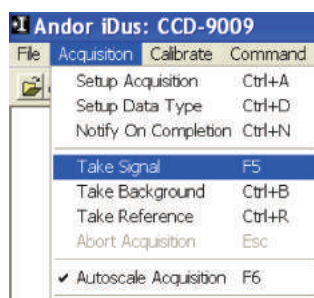

The Data Window opens, (labeled #0 Acquisition) and displays the acquired data, according to the parameters selected on the Setup Acquisition Dialog box. e.g.:

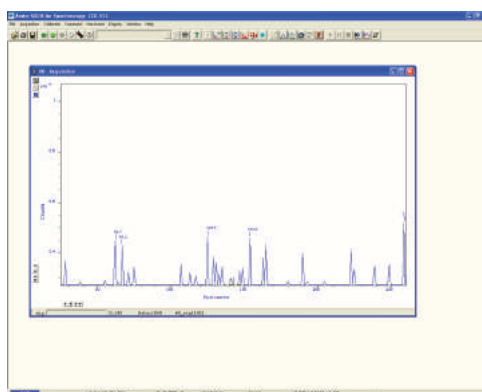

#n uniquely identifies the data set while the data set is being displayed and is temporary. It ceases to be associated with the data set once you close all data windows bearing the same #n. It is often referred to as an Acquisition Window. **NOTE: Each data window has the same name and #n (which identify the Data Set), but a unique number, following the data set name, to identify the window itself. Data can be modified only in a data window labeled with the name and the #n of the data set to which the data belong. If you modify a data set and attempt to close the data window, you will be prompted to save the data set to file.**

If you have selected Accumulate or Kinetic as the Acquisition Mode, new data will continue to be acquired and displayed until you carry out one of the following actions:

- Select Abort Acquisition from the Acquisition drop-down menu
- Click the  button
- Press the <ESC> key

This stops any data capture process that may be under way. Information on how to capture & view more detailed data is contained in the pages that follow.

5.2 - DATA TYPE SELECTION

You can select the type of information that you want the system to compute and display whenever you perform the Take Signal function. When the Setup Data Type option of the Acquisition drop-down menu is selected, the Data Type dialog box opens:

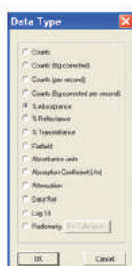

The descriptions of the data types are shown in **Table 7** which follows on this page and the next. The acquired data are presented under the **Sig** tab of an Acquired Data Window.

The data type selected will also determine whether you need to take a background and/or a reference scan using the **Take Background** and/or **Take Reference** options. These options are described in more detail on page 53).

5.2.1 - Definitions of data types

- **Signal:** data in uncorrected Counts
- **Background:** data in uncorrected Counts, acquired in darkness
- **Reference:** background corrected data. Reference data are normally acquired from the light source, without the light having been reflected from or having passed through the material being studied

Table 7 - Data Types

OPTION	FUNCTION
Counts	Counts represent raw, digitized data (i.e. no calculations have been performed on the data) from the CCD detector's analog to digital (A/D) converter. Please refer to the detailed performance sheet accompanying your particular CCD detector for the number of electrons that correspond to 1 count.
Counts (Bg corrected)	Counts (Background Corrected) is digitized Data from the CCD detector's analog to digital (A/D) converter, where Background (or dark signal) has been removed. Counts (Bg. Corrected) = Signal - Background
Counts (per second)	Counts ÷ Exposure Time.
Count (Bg corrected per second)	Counts (Bg corrected) ÷ Exposure Time.
%Absorbance	Represents the light absorbed by an object. If Reference is the background corrected incident intensity, and Signal - Background the transmitted intensity (i.e. the intensity of light which has passed through the material being examined), then: $\% \text{ Absorbance} = 100 \times (1 - (\text{Signal} - \text{Background}) / \text{Reference})$
%Reflectance	Represents the light reflected by an object. If Reference is the background corrected incident intensity, and Signal - Background the reflected intensity (i.e. the intensity of light which has been reflected from the material being examined), then: $\% \text{ Reflectance} = 100 \times (\text{Signal} - \text{Background}) / \text{Reference}$
%Transmittance	Represents the light transmitted by an object. If Reference is the background corrected incident intensity, and Signal - Background the transmitted intensity (i.e. the intensity of light which has been transmitted through the material being examined), then: $\% \text{ Transmittance} = 100 \times (\text{Signal} - \text{Background}) / \text{Reference}$
Flatfield	Flatfield is used to remove any pixel-to-pixel variations that are inherent in the CCD sensor. If Reference is the background corrected incident intensity, the Signal is divided by the Reference so: Flatfield = M x Signal / Reference Where M is the Mean of Reference.

Table 7 - Data Types (continued)

OPTION	FUNCTION
Absorbance units	A measure of light absorbed by an object (i.e. they represent the object's Optical Density - OD). If Reference is the background corrected incident intensity, and Signal - Background the transmitted intensity (i.e. the intensity of light which has passed through the material being examined), then transmission = (Signal - Background) / Reference. Absorbance Units are defined as Log10 (1 / Transmission). Therefore: Absorbance Units = Log10 (Reference / (Signal - Background)).
Absorption Coefficient (/m)	Indicates the internal absorbance of a material per unit distance (m). It is calculated as -log _e t, where t is the unit transmission of the material and log _e is the natural logarithm. If Reference is the background corrected incident intensity, and Signal - Background the transmitted intensity (i.e. the intensity of light which has passed through the material being examined), then: Transmission = (Signal - Background) / Reference and: Absorption Coefficient = -log _e ((Signal - Background) / Reference)
Attenuation	A measurement, in decibels, of light absorbed due to transmission through a material - decibels are often used to indicate light loss in fiber optic cables, for instance. If Reference is the background corrected incident intensity, and Signal - Background the transmitted intensity (i.e. the intensity of light which has passed through the material being examined), then: Attenuation = 10 x log ₁₀ ((Signal - Background) / Reference)
Data*Ref	Allows you to 'custom modify' the background corrected signal: Data x Ref = (Signal - Background) x Reference Store Value See the Andor Basic Programming Manual for similar operations.
Log 10	Calculates the logarithm to the base 10 of the background corrected signal counts. Log Base 10 = log ₁₀ (Signal - Background)
Radiometry(Optional extra)	Allows you to calculate values for radiance or irradiance. The system requires that you supply calibration details. This option must be ordered separately.

As an example, the system will compute % Absorbance as:

$$100 \times (1 - (\text{Signal} - \text{Background}) / \text{Reference}).$$

The illustration below shows a typical use of Background, Reference and Signal for computations such as

%Absorbance or %Transmittance:

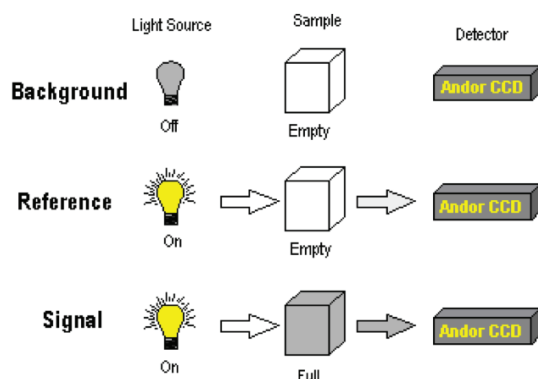

USE OF BACKGROUND, REFERENCE & SIGNAL

Example: % Transmittance, % Absorbance

The default data type (used when you capture data and have not explicitly made a selection from the Data Type dialog box) is **Counts**.

- If you select any data type **other than** Counts or Counts (Bg Corrected) you will have to perform Take Background and Take Reference (in that order) before performing Take Signal.

The calculations for the various data types assume the following definitions:

- > **Signal:** uncorrected raw data acquired via **Take Signal**. 'Signal', as used in the definitions of the calculations, refers to **'raw'** data from the CCD and should not be confused with the possibly 'processed' data to be found under the **Sig** tab of the Data Window.
- > **Background:** data in uncorrected Counts, acquired in darkness, via **Take Background**.
- > **Reference:** background corrected data, acquired via **Take Reference**.

5.3 - DATA FLIPPING

For some spectrographs, it may be necessary to change the direction in which data is read out. Simply click the **Horizontally** tick box in the **Flip** section of the **FVB** tab as shown:

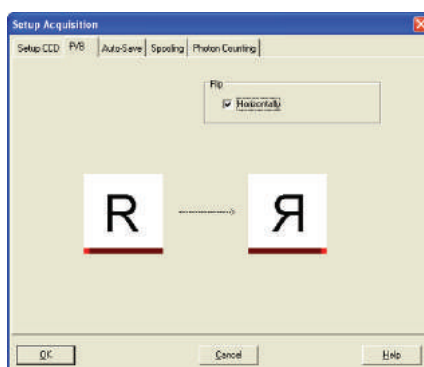

An example of flipped spectra is shown here:

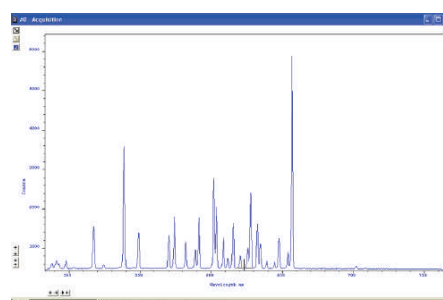
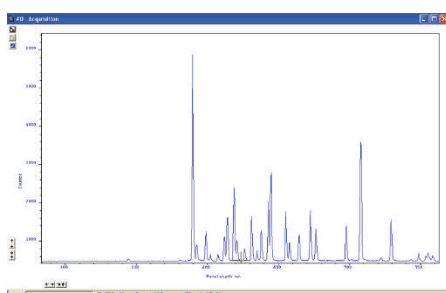

5.4 - ACQUISITION TYPES

From the Acquisition drop-down menu on the Main Window, you can make the following data acquisition selections:

- **Take Signal**
- **Take Background**
- **Take Reference**

Provided you do not change the acquisition parameters, the scans you take for background and reference are automatically used for subsequent data acquisitions whenever you perform Take Signal.

5.4.1 - Autoscale Acquisition

Prior to the **Take Signal** function being activated, **Autoscale Acquisition** can be selected from the Acquisition drop-down menu as shown (alternatively, press **F6** on the keyboard):

Acquisition	Calibrate	Command
Setup Acquisition		Ctrl+A
Setup Data Type		Ctrl+D
Notify On Completion		Ctrl+N
Take Signal		F5
Take Background		Ctrl+B
Take Reference		Ctrl+R
Abort Acquisition		Esc
✓ Autoscale Acquisition		F6

- With Autoscale Acquisition deselected, the display will remain the same size regardless of brightness settings, etc. When selected off, the  button appears (click this button to switch back on).
- With Autoscale Acquisition selected, the system will configure the Acquisition Window (if necessary adjusting its scales in real time) so that all data values are displayed as they are acquired. The

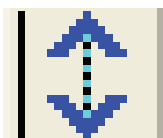

button appears when selected on. The data are displayed in accordance with the selection made on the Rescale Data Mode on the Display Menu:

You can choose to display values between the following parameters:

- **Minimum & maximum (Min..Max)**
- **Zero & maximum (0..Max)**
- **Zero & 65535 (0..65535)**
- **Minimum & 65535 (Min..65535)**
- **Custom setting as required**

For further information on Rescale, please refer to page 90.

5.4.2 - Take Background

The Take Background option of the Acquisition drop-down menu instructs the system to acquire raw background data. These are as counts of the Acquisition Window. No calculations are performed on these data.

The data type you select via Setup Data Type on the Acquisition Menu may require you to perform Take Background before you perform Take Signal.

NOTE: You do not necessarily have to take background data prior to each acquisition of signal data. If the data acquisition parameters remain unchanged since you last performed Take Background, then no NEW background data are required.

5.4.3 - Take Reference

The Take Reference option of the Acquisition drop-down menu instructs the system to acquire background corrected data that will be used subsequently in calculations that require a reference value. Before executing this function you must therefore perform a Take Background. The data you acquire using Take Reference are displayed as counts minus background under the Ref tab of the Acquisition Window.

NOTE: The data type you select via Setup Data Type on the Acquisition menu may require you to perform Take Reference before you perform Take Signal.

5.4.4 - Acquisition Errors

If you perform an operation “out of sequence”, the system will prompt you by launching an Acquisition Error message, e.g.

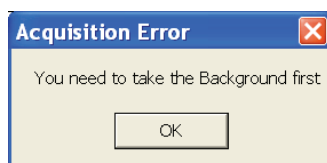

5.5 - ACQUISITION MODES & TIMINGS

An acquisition is taken to be the complete data capture process that is executed whenever you select **Take Signal**, **Take Background** or **Take Reference** from the Acquisition menu or whenever you click the  button. By contrast, a scan (an 'Acquired Scan' in the definitions that follow) is 1x readout of data from the CCD-chip. Several scans may be involved in a complete data acquisition.

The minimum time required for an acquisition is dependent on a number of factors, including the Exposure Time (the time in seconds during which the CCD collects light prior to readout.) and the Triggering mode. Triggering modes are described in more detail later in this section.

5.5.1 - Single Scan

Single scan is the simplest acquisition mode, in which the system performs one scan of the CCD.

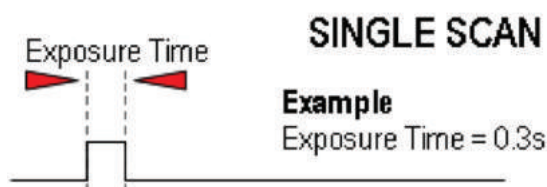

NOTE: Should you attempt to enter too low a value, the system will default to a minimum exposure time.

5.5.2 - Real Time

If you click the  button, the system repeatedly performs a single scan and updates the data display.

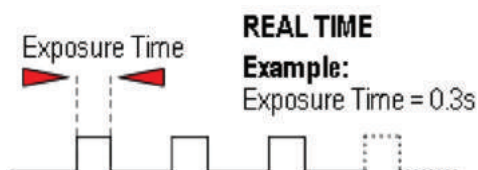

New data will continue to be acquired and displayed until you either :

- Select Abort Acquisition from the Acquisition Menu
- Click the  button
- Press the ESC key.

This stops any data capture process that may be under way.

NOTE: This is a useful mode if, for example, you want to capture data as you optimize a hardware set-up.

5.5.3 - Accumulate

Accumulate mode allows you to add together in computer memory the data from a number of scans to create an 'Accumulated Scan' i.e.

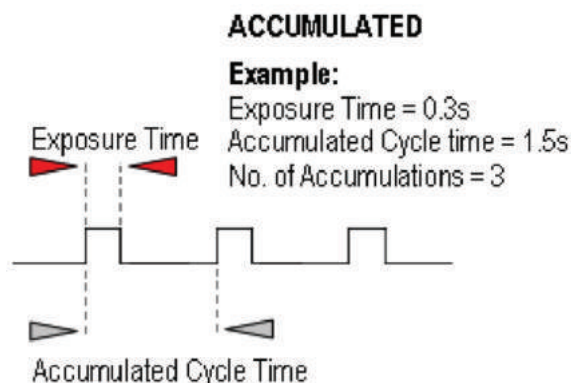

You can select the following parameters in the Setup Acquisition dialog box:

- **Exposure Time**
- **Accumulated Cycle Time:** the period in seconds between each scan. This parameter is only available if you have selected Internal triggering (please refer to **Triggering Modes** on page 50).
- **No. of Accumulations:** the number of scans you want to add together.

NOTE: This mode is used to improve the Signal to Noise ratio.

5.5.4 - Kinetic Series & Accumulated Kinetic Series

In the Setup Acquisition dialog box you can key in the following parameters, which relate both to the kinetic series itself (and where marked *, to the accumulation process):

- **Exposure Time**
- **Accumulate Cycle Time*:** the period in seconds between the individual scans (see **Number of Accumulations** below) that are accumulated in computer memory to create each member of your kinetic series - each member of the series is an 'accumulated scan'. This parameter is only available if you have selected Internal Triggering.
- **Number of Accumulations*:** the number of scans you want to add together to create each member of your kinetic series. The default value of 1 means that each member of the kinetic series will consist of a single scan.
- **Kinetic Cycle Time:** the interval at which each scan (or set of accumulated scans) begins. This parameter is only available if you have selected Internal Triggering.
- **Number in Kinetic Series:** the number of scans or accumulated scans you require in your series.

KINETIC SERIES

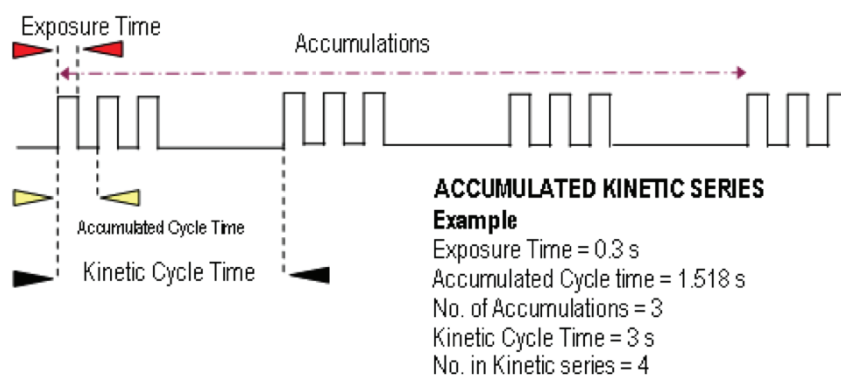
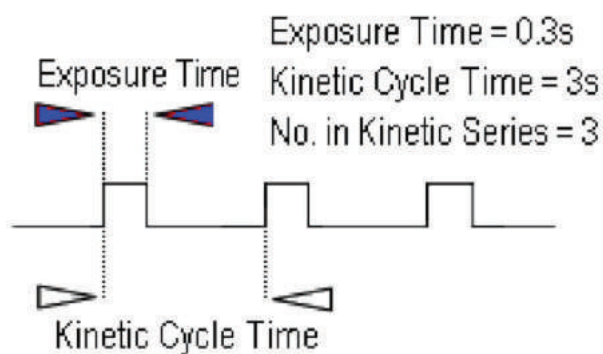

NOTE: This mode is particularly well suited to recording the temporal evolution of a process.

5.6 - TRIGGERING MODES

The Triggering modes are selected from a drop-down list on the Setup Acquisition dialog box:

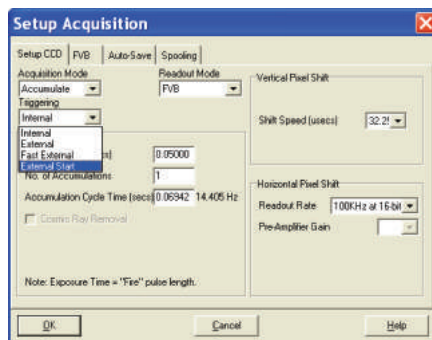

5.6.1 - Internal

In Internal mode, once you issue a data acquisition command, the system determines when data acquisition begins. You can use Internal mode when you are able to send a trigger signal or 'Fire Pulse' to a short-duration, pulsed source (e.g. a laser). In this case starting data acquisition also signals the pulsed source to fire. The Fire Pulse is fed from the **Fire** SMB connector on the rear of the camera. Internal Trigger Mode is also used with 'Continuous Wave' (**CW**) sources (an ordinary room light, for instance), where incoming data, for the purposes of your observation, are steady and unbroken. This means that acquisitions can be taken at will.

IMPORTANT NOTE ON EXTERNAL TRIGGER FUNCTIONS: If you have a shutter connected and are using external triggering, you must ensure that the shutter is open before the optical signal you want to measure occurs.

5.6.2 - External

In External mode, once you issue a data acquisition command, data will not be acquired until your system has received an External Trigger signal generated by an external device (e.g. a laser). The External Triggering signal is fed to the Ext Trig SMB connector on the rear of the camera.

5.6.3 - Fast External

Normally, when using External Trigger the system will only enable the triggering of the system after a complete Keep Clean Cycle has been performed. This is to ensure that the CCD is always in the same known state before it is triggered. This is particularly important when the system is in Accumulation or Kinetics mode. In cases where repetition rate is paramount, and slight variation in the base background level is less important, it is possible to remove this restriction by using Fast External triggering. The Keep Clean process is continuous on the iDus and any delay is negligible.

5.6.4 - External Start

With External Start triggering, once you issue a data acquisition command, data will not be acquired until your system has received an external trigger signal generated by an external device. The system will then continue to acquire data based on user options set within the Acquisition Dialog.

This means that an External Start Trigger could be used to commence acquisition of a Kinetic series, but with the parameters of that series being controlled by internal software options. The External Start trigger signal is fed to the camera head via the Ext Trig SMB on the back of the camera.

5.7 - SELECTING TRIGGER TYPE

The following flowchart will help you decide whether you should use Internal, External, External Start or Fast External triggering:

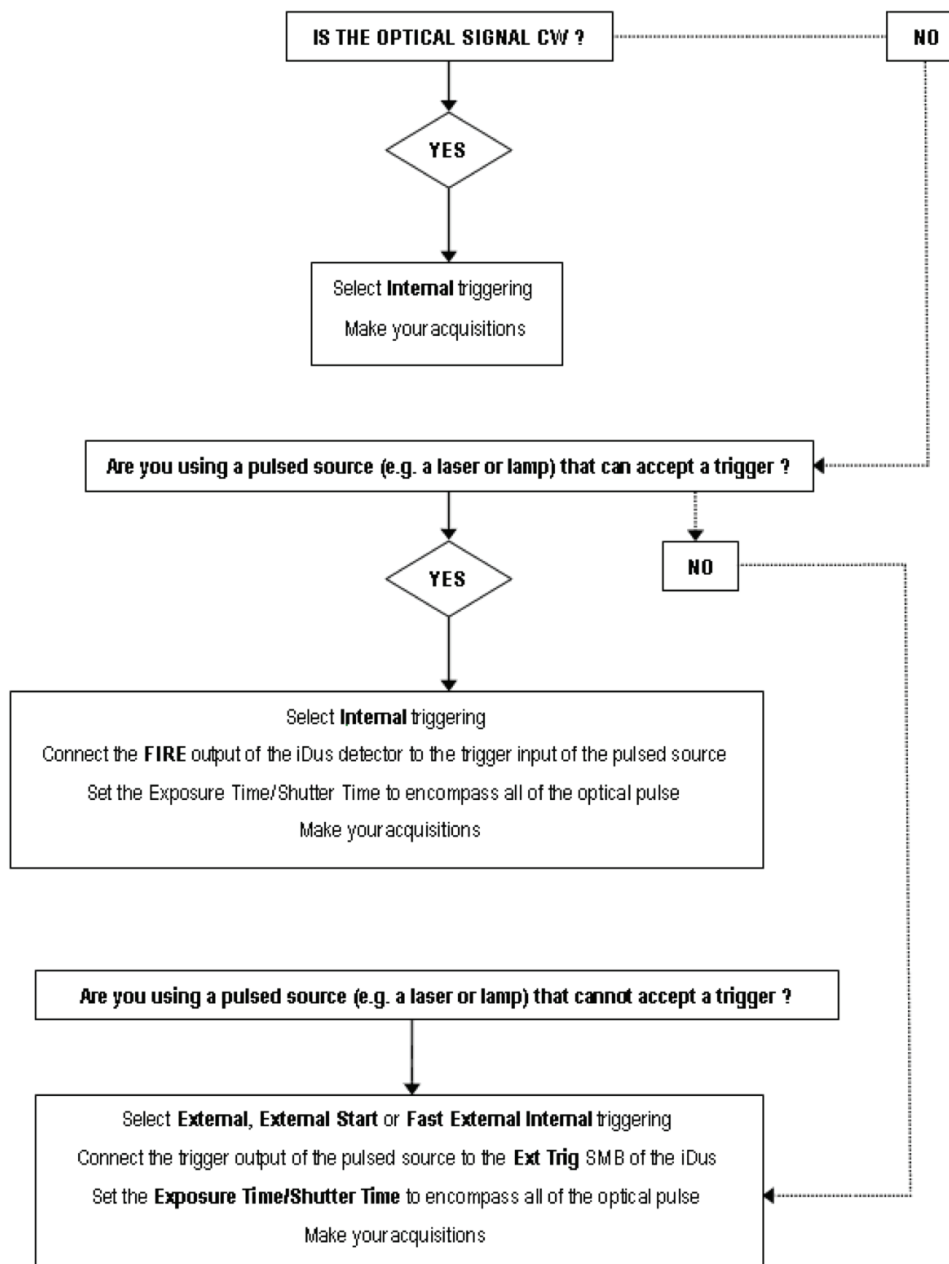

5.8 - READOUT MODES

The Readout Modes available from the Setup Acquisition dialog box let you use the CCD chip at the heart of the camera to collect/readout data. The options available are as follows:

- **FVB (Full Vertical Binning)**
- **Multi-Track**
- **Random Multi-Track**
- **Image**

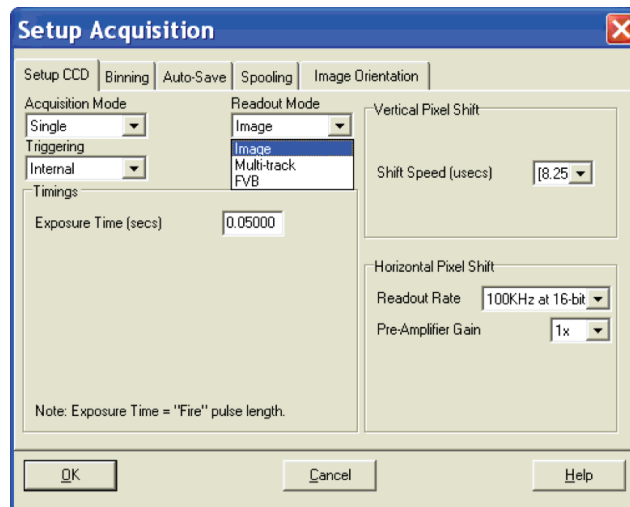

The Binning patterns used in each readout mode are as follows:

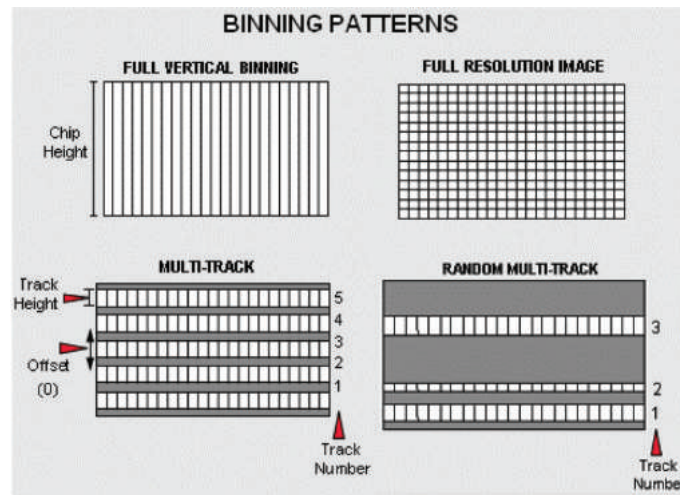

Binning is a process that allows charge from two or more pixels to be combined on the CCD-chip prior to readout. For a full explanation of binning please refer to **page 138**.

NOTE: The examples given in this manual to illustrate the use of binning patterns are based on a 30-11 chip with 1024 x 256 pixels, each pixel measuring 26 μm^2

5.8.1 - Full Vertical Binning

FVB allows you to use the CCD-chip as a **Linear Image Sensor** (cf. **PhotoDiode Array** or **PDA**). The charge from each column of pixels (each column being chip height) is combined on the chip, or binned, to give a single value per column. To define the binning in FVB mode, click on the **FVB** tab in the Setup Acquisition dialog box and the following dialog box appears:

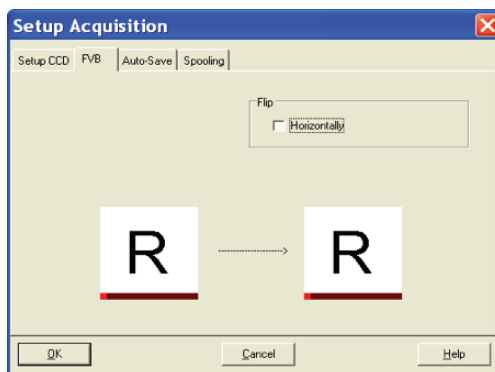

For some spectrographs, it may be necessary to change the direction in which data is read out. Simply click the **Horizontally** tick box in the **Flip** area as shown:

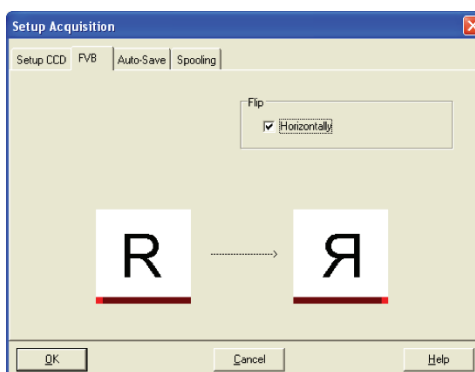

An example of flipped spectra is shown here:

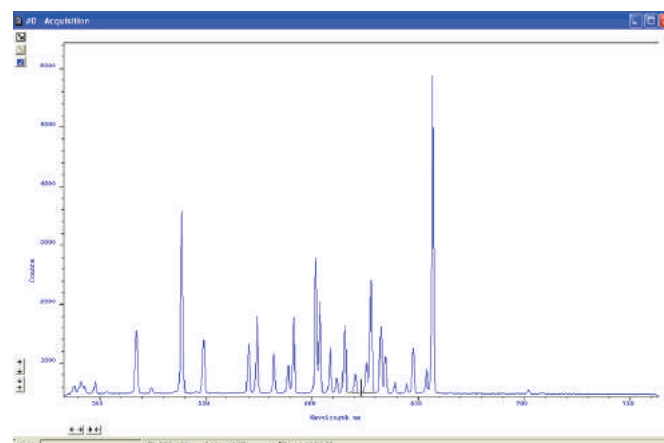
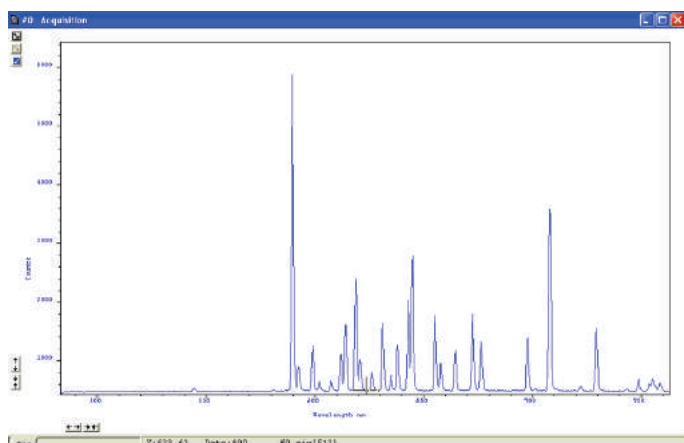

5.8.2 - Multi-track

Multi-track mode allows you to create one or more tracks. You can define (in rows) the height of each track, and the offset, which in effect, 'raises' or 'lowers', on the CCD-chip, the pattern of tracks from which you will readout charge. In this way you can adjust the position of the tracks to match a light pattern produced on the CCD-chip by a fiber bundle, for example. The vertical spacing of the multiple tracks is intended to match the light patterns produced by Andor imaging spectrographs and Andor fiber bundles.

To define multiple tracks on the CCD-chip, click on the **MT Setup...** tab in the Setup Acquisition dialog box. The **Setup Multi-track** dialog box appears e.g.:

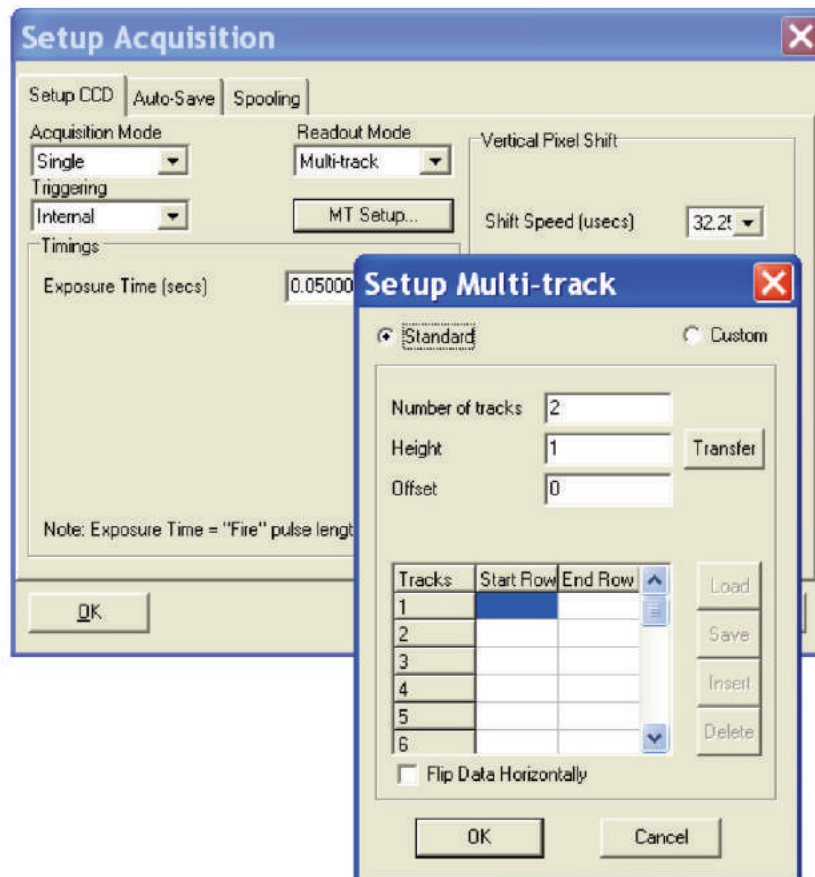

Select **Standard** and put in the required parameters, e.g.:

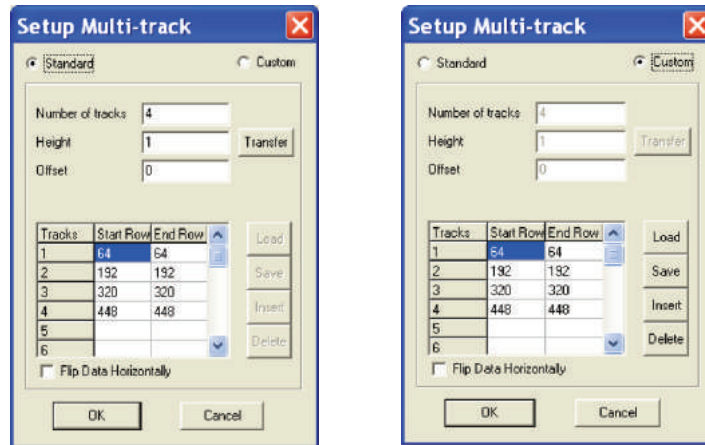

If you click on the Transfer button, the mode changes to **Custom** and the values that were used in Standard mode are moved in to the table as shown above. The **Load, Save, Insert & Delete** buttons also become active. Multi-track files (*.mtr) can then be **Opened, Saved, Inserted** or **Deleted** as required, e.g.:

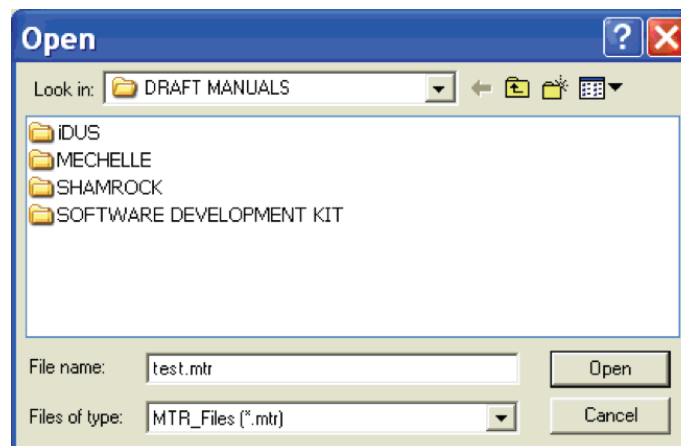

When all the parameters have been selected, the display should be similar to the following:

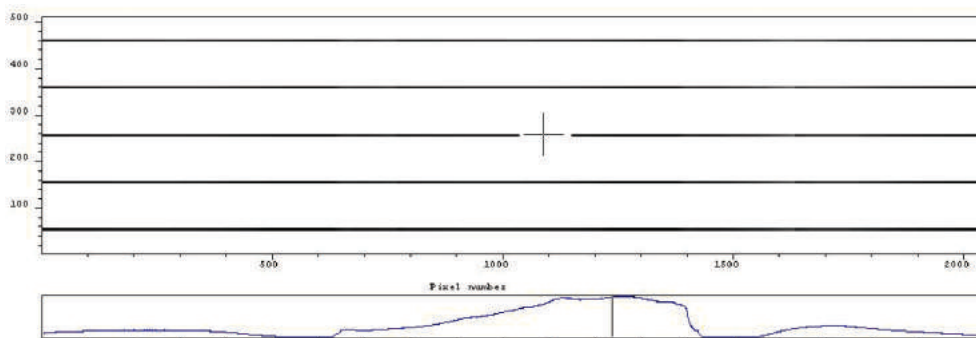

5.8.3 - Random Multi-track

In Random Multi-track mode the position and height of each track is specified by the user, unlike Multi-track mode where the driver sets the position of each track automatically.

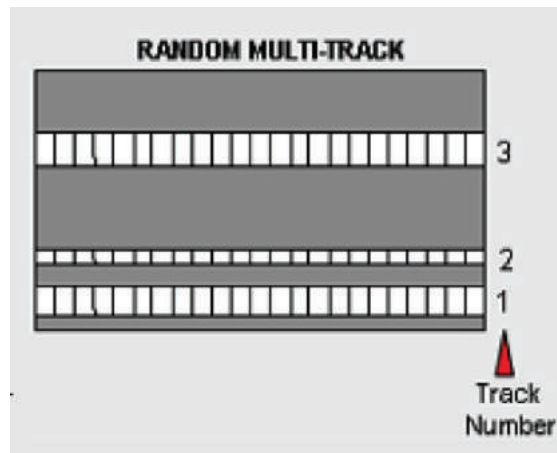

Random Multi-track will allow you to simultaneously acquire a number of spectra, delivered typically via a fiber bundle. Unless you are acquiring data from a pulsed source you will need to use a shutter to avoid streaking the spectra during the binning process. When all the parameters have been selected, the display should be similar to the following:

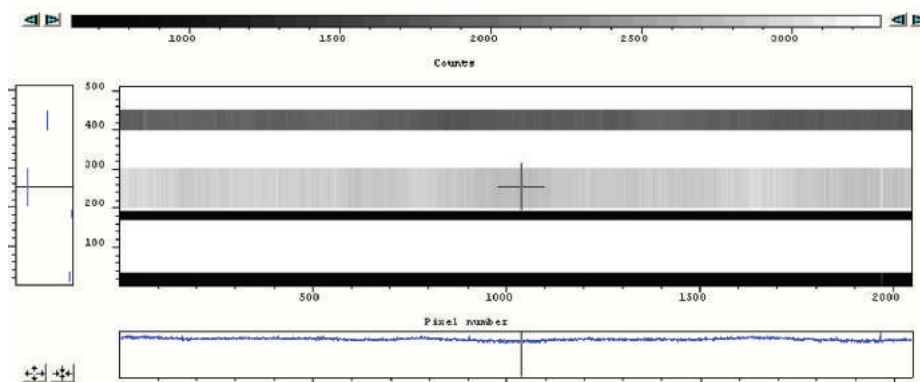

NOTES ON RANDOM MULTI-TRACK:

1. A track of 1 row in height will have the same start and end positions.
2. Before using Random Multi-track mode with fiber bundles it is often useful to acquire a full resolution image of the output.
3. Having observed the vertical positions of the individual spectra, set the Random-track mode accordingly.
4. Imaging spectrographs vertically invert input light (i.e. light from the top fiber will fall on the bottom track of the CCD-chip.)
5. Random tracks are limited to 20 tracks

5.8.4 - Image

Image mode supplies you with a count from each pixel on the CCD, in effect allowing you to take a picture of the light pattern falling on the pixel matrix of the CCD. This default is referred to as a **Full Resolution Image**. The image may be viewed in Grayscale or false color, or displayed as 2D or 3D traces. To define the binning in Image mode, click on the **Binning** tab in the **Setup Acquisition** dialog box, then type in the required parameters, e.g.:

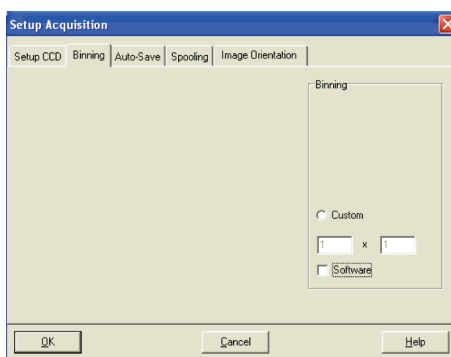

The display should be similar to the following:

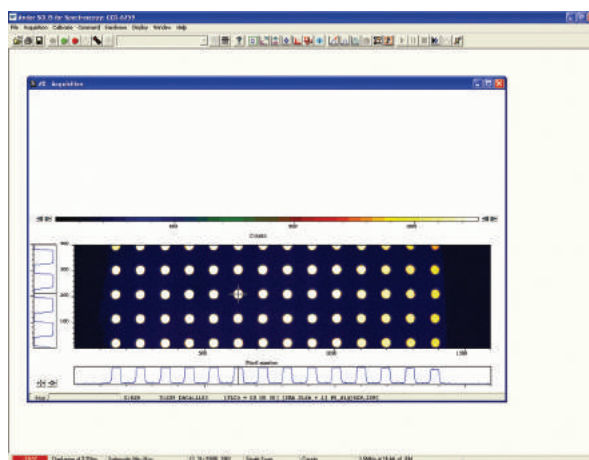

5.8.4.1 - Image Orientation

In Image mode, the data can also be orientated as they are acquired. This is particularly useful if the CCD-chip has a readout register along its short, vertical edge. Without rotation, images would by default appear sideways on screen.

To orientate the image data, click the Spectral Orientation tab on the Setup Acquisition dialog box, then select the required parameters with the appropriate check buttons, e.g.:

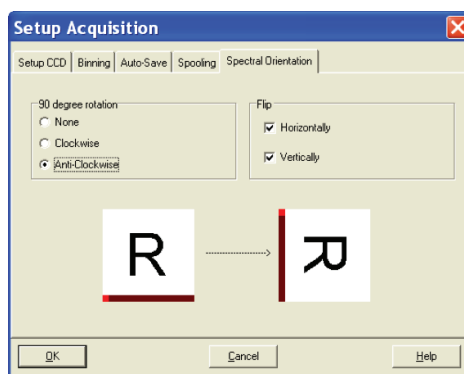

5.8.5 - Horizontal Pixel Shift Readout Rate

This defines the rate at which pixels are read from the shift register. The faster the readout rate, the higher the frame rate that can be achieved. Slower readout rates will generate less noise in the data as it is read out. The rate can be selected from a drop-down list on the Setup Acquisition dialog box. The options available are as follows:

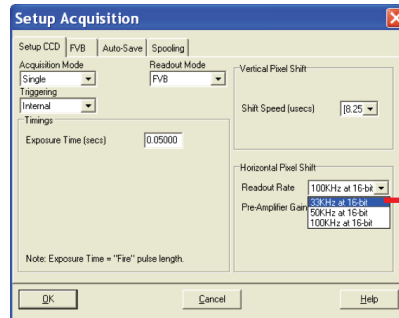

- 33 kHz @ 16-bit
- 50 kHz @ 16-bit
- 100 kHz @ 16-bit

5.8.6 - Vertical Pixel Shift Speed

The Vertical Pixel Shift Speed is the speed at which charge is moved down the CCD-chip. The speed is actually given as the time in microseconds taken to vertically shift one line, i.e. shorter times = higher speed. The speed you select will affect the minimum exposure and cycle times available. The options available will vary depending on the system, but typical values are as follows:

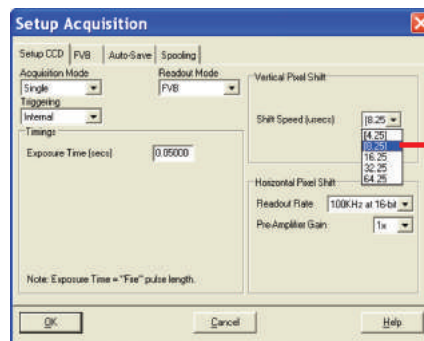

- (4.25) μ secs
- (8.25) μ secs
- 16.25 μ secs
- 32.35 μ secs
- 64.25 μ secs

NOTE: Operation is guaranteed at the 'unbracketed' speeds. At the faster ('bracketed') speeds there may be some degradation of CTE (Charge Transfer Efficiency). These faster speeds are offered as the user may wish to accept a reduced CTE to increase repetition rates. The speeds offered ('bracketed' and 'unbracketed') will vary depending on the type of system purchased.

5.9 - TIMING PARAMETERS

Depending on which combination of Acquisition, Readout & Triggering modes is selected, various timing parameters are available as follow:

- **Exposure Time (secs)**
- **No. of Accumulations**
- **Accumulation Cycle Time (secs)**
- **Cosmic Ray Removal**
- **Kinetic Series Length**
- **Kinetic Cycle Time (secs)**

5.10 - SHUTTER

When the **Shutter Control** option is selected from the **Hardware** drop-down-menu, or the  button is clicked, the Shutter Control dialog box opens e.g.:

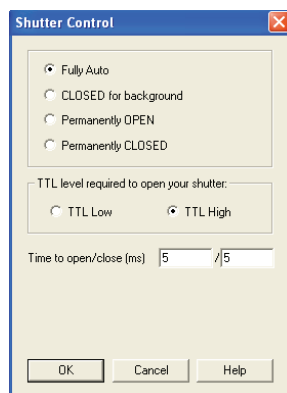

You can use this to indicate when and how a hardware shutter should be used. With a CCD, the shutter is used for background shuttering. Certain settings (e.g. **Permanently OPEN & Permanently CLOSED**) take effect as soon as you close the Shutter Control dialog box. Other settings will be applied whenever you acquire data.

- **Fully Auto** is the simplest shutter mode, as it leaves all shuttering decisions to the system. When you perform Take Signal the shutter opens for the duration of the Exposure Time you have entered in the Setup Acquisition dialog box.

NOTE: This option will automatically provide suitable shuttering for the majority of data acquisitions. The shutter will be closed for background data acquisitions and will be opened for all other data acquisitions.

- If CLOSED for background mode is selected, any shutter driven from the Shutter output will be closed as you perform Take Background. If you want the shutter to be open so that the Take Background function records genuine optical background data, deselect the option.

NOTE: Usually a background scan is used to subtract the dark signal and the Fixed Pattern Noise (FPN) of the sensor. For this reason the background scan is usually performed in darkness. A shutter may be used to stop light entering the spectrograph or other imaging system. Strictly speaking though, the background acquisition may be regarded as comprising all light with the single exception of the source. Thus, when you are working with a pulsed or independently shuttered source, it may be appropriate to have the mode deselected.

- In **Permanently OPEN** mode, the shutter will be open before, during and after any data acquisition.
- **Permanently CLOSED** mode can be useful if you want to take a series of acquisitions in darkness and do not require the shutter to open between acquisitions. You might, for example, wish to capture a sequence of background values. The shutter remains closed before, during and after any data acquisition.
- The TTL (Transistor-Transistor Logic) buttons, **TTL Low & TTL High**, let you instruct the system as to how it should control the opening and closing of the shutter.
 - > If you select **TTL Low**, the system will cause the output voltage from the iDus to go 'low' to open the shutter.
 - > If you select **TTL High**, the system will cause the output voltage from the iDus to go 'high' to open the shutter.

The documentation supplied by the shutter manufacturer will show whether your shutter opens at a high or a low TTL level. An illustration of the TTL structure is shown on the next page.

NOTE: The shutter pulse is not capable of driving a shutter. It is only a 5V pulse designed to trigger TTL & CMOS compatible shutter drivers. Also there is no shutter pulse during the Take Signal and Take Reference data acquisitions.

TTL & CMOS
COMPATIBLE

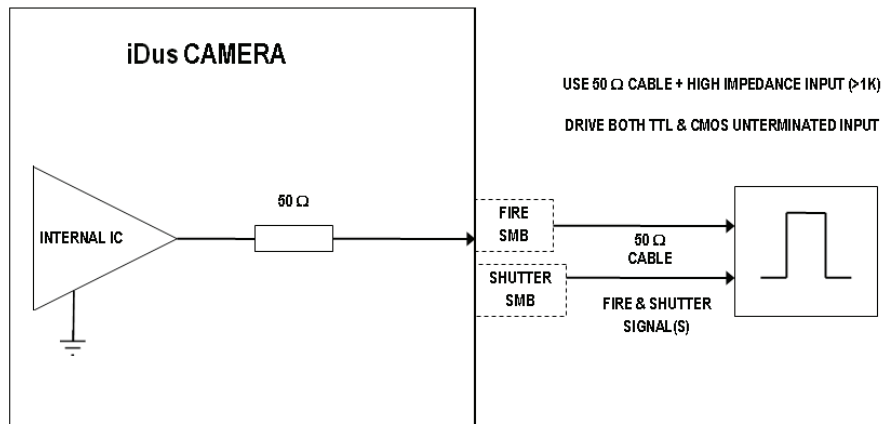
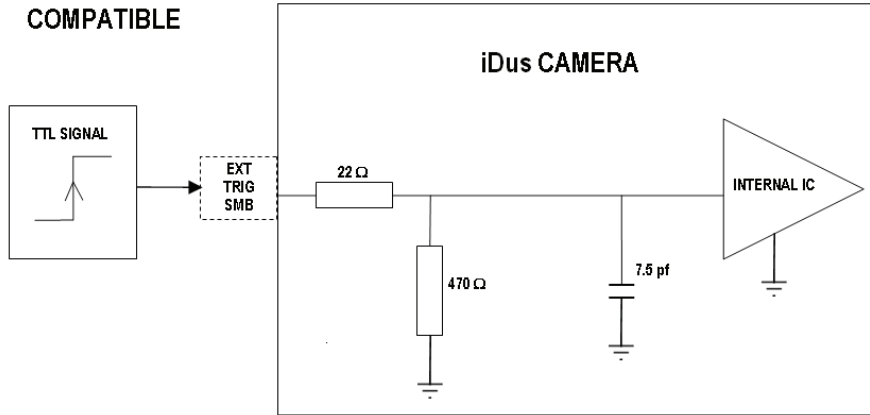

5.10.1 - Time to open or close

Shutters take a finite time to open or close and this is sometimes called the **Shutter Transfer Time (STT)**. The documentation supplied by the shutter manufacturer should indicate the STT you can expect from your particular shutter. In the case of a CCD detector, the STT gives enough time for the shutter to open before acquisition starts and enough time to close after acquisition finishes and before readout commences.

Let us look at the STT in the context of the Andor system. By default, the value you enter in the **Exposure Time** text box in the **Setup Acquisition** dialog box determines the length of time the shutter will be in the open state. However, to accommodate the STT, the rising edge of the shutter output is sent before the **FIRE** output signal by an amount equal to the STT. You should set this value to the Transfer Time of your shutter.

The system also automatically adds the STT to the end of the acquisition sequence, introducing an appropriate delay between the start of the shutter closed state and the commencement of the data being read out as shown in the following example diagram:

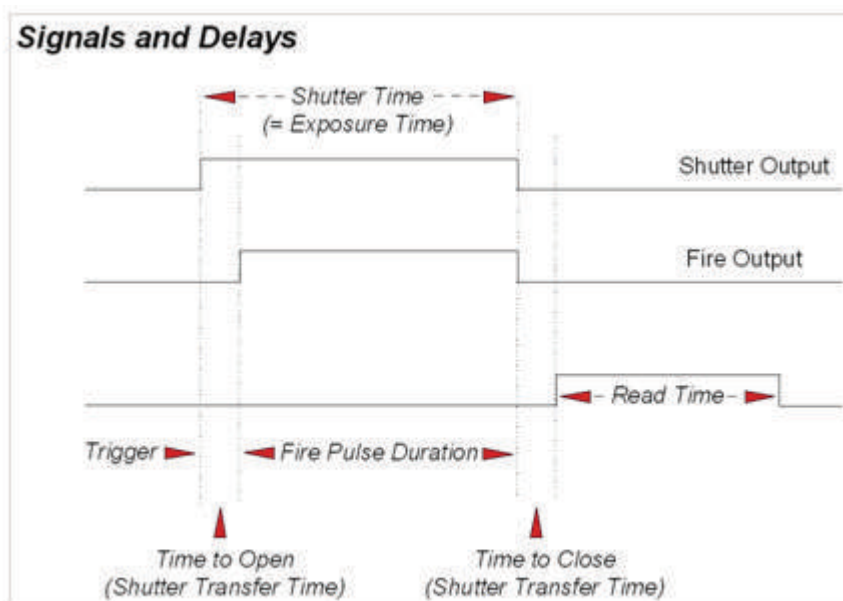

If you do not have a shutter connected, set the Time to open or close to 0. Setting the Time to open or close to any other value will insert extra delays into cycle time calculations.

5.10.2 - Exposure Time

As mentioned previously, Exposure Time (secs) is the time during which the CCD collects light prior to readout. The system will default to a minimum Exposure Time should you attempt to enter too low a value.

You will notice that the Exposure Time caption changes to Shutter Time if you have selected a Readout Mode other than Full Vertical Binning. The caption changes to reflect the fact that the CCD will be exposed to light for the duration of the Shutter Time (which includes any transfer time).

If your binning pattern is **Full Vertical Binning**, the shutter, if connected, will remain in the **Open** position at all times, except when background data are being acquired. If you want the equivalent of Full Vertical Binning but with shutter operations, choose Single Track, with the Track Height set to maximum.

5.10.3 - Accumulate Cycle Time & No. of Accumulations

If you have selected Accumulate or Kinetic as the acquisition mode, with Internal triggering, you can also select the Accumulation Cycle Time and No. of Accumulations.

The Accumulation Cycle Time is the period in seconds between each of a number of scans, whose data are to be added together in computer memory to form an Accumulated Scan.

The Number of Accumulations indicates the number of scans you want to add together.

5.10.4 - Kinetic Series Length & Kinetic Cycle time

When Kinetic is selected as the acquisition mode, with Internal triggering you can also select the Kinetic Series Length and Kinetic Cycle Length (secs).

- **Kinetic Series Length:** the number of scans you require in your series
- **Kinetic Cycle Length:** the interval (in seconds) at which each scan (or accumulated scan) in your series begins

5.11 - COSMIC RAYS

Cosmic rays are very high energy particles, originating in outer space, that enter the Earth's atmosphere and produce a shower of further high energy particles. When one of these particles passes through the CCD it will produce between 0 and thousands of photoelectrons in a very small area (usually 1 to 4 pixels) and due to the low read noise of the CCD this will appear as a spike of up to several hundred counts.

If the Cosmic Ray Removal option is selected, each scan will be compared with the previous one, for the presence of unusual features. An example of a unusual feature is shown here:

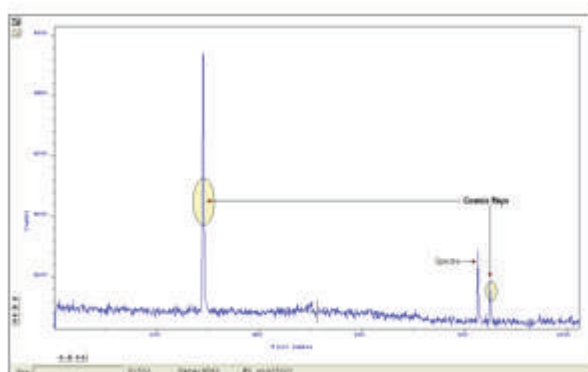

If one is found, its pixel value will be replaced with a scaled version of the corresponding scan, e.g.:

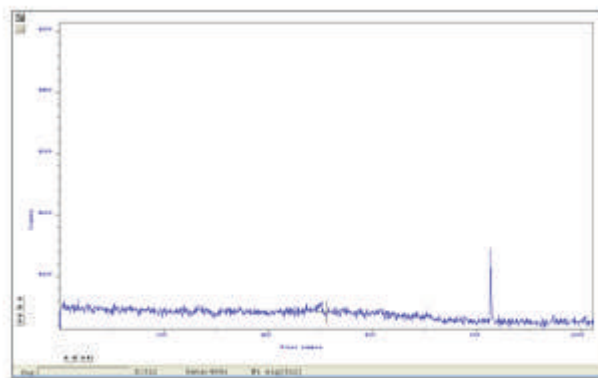

NOTE: This option is only available if there are 2 or more scans to compare. It takes twice as long to acquire one data set.

5.12 - FILE INFORMATION

Details of the Acquisition selection can be viewed by clicking the  button on the Main Window which opens the Information dialog box (you can enter your own notes in the Comments box):

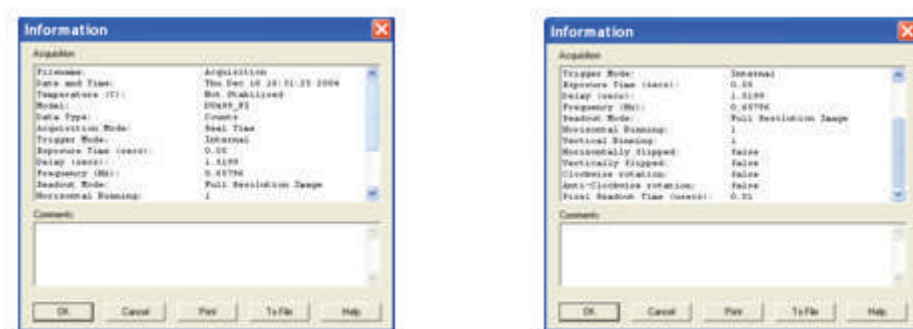

The table below details the type of information contained in the dialog box.

Table 8: Information Types

Filename	The filename associated with the active Data Window. If the data has not yet been saved this will default to Acquisition
Date and time	The date & time at which the acquisition was made.
Temperature (C)	The temperature to which the camera had been cooled.
Model	The model number of the camera
Data Type	Data Type: Counts, % Transmittance, etc.
Acquisition Mode	Single, Accumulate or Kinetic
Trigger Mode	Internal, External or Fast External
Exposure Time (secs)	"Fire" pulse length
Delay (secs)	Value in microseconds
Horizontal Binning	Always = 1
Vertical Binning	Minimum = 1, Maximum = 256
Horizontally flipped	True or False
Vertically flipped	True or False
Clockwise rotation	True or False
Anti-clockwise rotation	True or False
Pixel Readout Time (usecs)	Value in microseconds

SECTION 6 - DISPLAYING DATA

6.1 - DISPLAY MODES

Once the parameters for the data acquisition have been set and data has been successfully acquired, there are 3 main options available to display the data as seen below.

- **2D**
- **3D**
- **Image**

The Display drop-down menu also offers a range of options to change the various formats of the display as shown below:

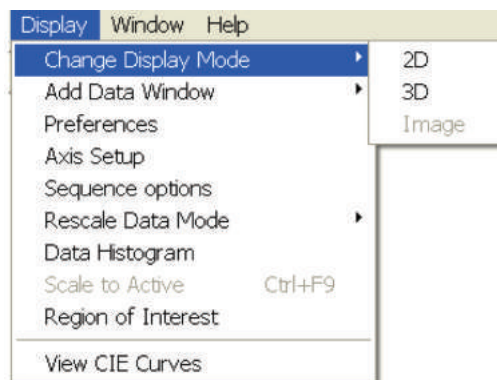

Some of the options are also available via icons on the Main Window and these are shown later in this section.

NOTE: The menu item Scale to Active is only available if you are in 2D display mode and have chosen to overlay a number of traces. This is explained in more detail in Overlay, on page 76.

6.2 - DISPLAY PREFERENCES

The way data is displayed in the various modes can also be changed. From the **Display** menu drop-down options, select the **Preferences**' option as shown:

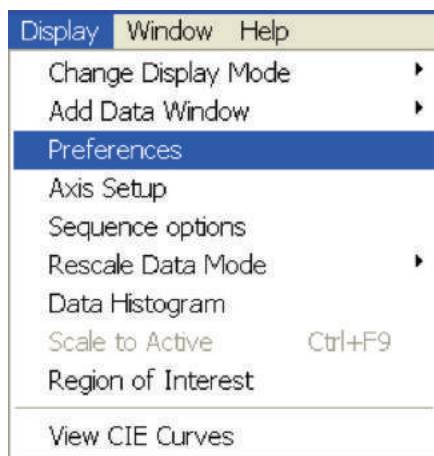

The **Display preferences**' dialog box appears, e.g.:

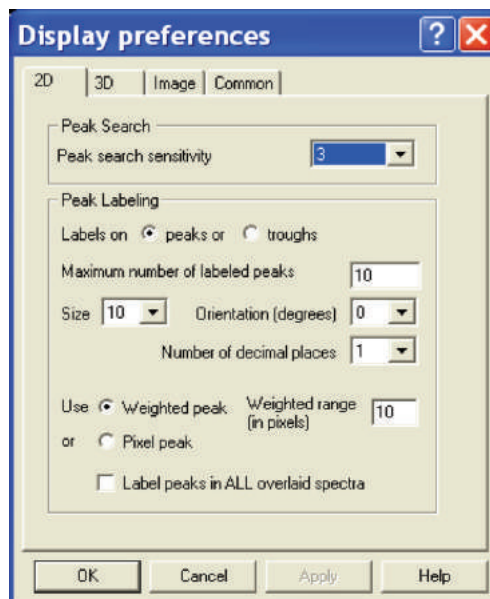

By clicking on the appropriate tab, you can select or deselect certain features associated with the data window for the mode of your choice.

6.3 - AXIS DEFINITIONS

In descriptions of the data window and in on-screen captions, the terms x-axis, y-axis and data-axis are used as follows:-

- The x- and y-axes define a pixel's position on the two-dimensional CCD-chip, e.g.:

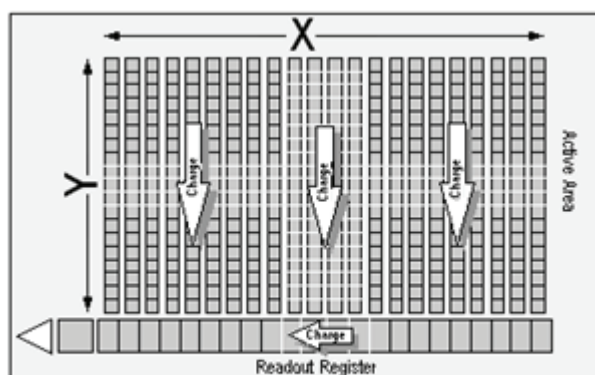

- The x-axis (or horizontal display axis) is parallel to the readout register and may be calibrated in pixels or in a unit of your choice.
- The y-axis (or vertical display axis) is perpendicular to the readout register and may be calibrated in pixels or in a unit of your choice.
- The data-axis is calibrated in the unit of your choice and has data values plotted against it. In 2D and 3D display modes, the data-axis is the vertical display axis. In Image Display Mode, data is represented by a color or a grayscale tone. For information on Calibration, please refer to **Section 8**.

In all display modes, x- and data-values are displayed on the status bar along the bottom edge of the Data Window.

When data has been acquired in a mode other than Full Vertical Binning, y-values are also displayed in the status bar.

6.4 - AXIS SETUP

When you are in 2D or 3D display mode and the **Axis Setup** option on the **Display** menu is selected, the **Axis Setup** dialog box opens, e.g.:



The minimum & maximum values you wish to appear on the x- and data-axes (the horizontal and vertical display axes respectively) of your data window can be entered in the text boxes.

If you select Axis Setup while you are viewing data in Image display Mode, the Axis Setup dialog box opens as shown:

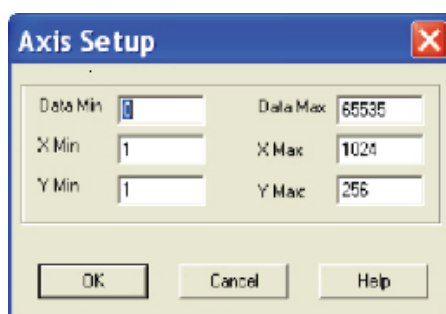

You can now also enter, in the text boxes, minimum & maximum values for the y-axis (the vertical display axis) of your data window. In a full resolution image, data is represented as a color or a grayscale tone.

You can now enter minimum & maximum x- and y- values of your choice, provided those values (when converted to pixels) do not exceed the width or height of the CCD-chip.

However, if you have selected **Always Maintain Aspect Ratio** in **Preferences**, the system may have to resize the 'plotting region' in which the image appears. The plotting region then, generally, occupies less of the available window space, but the aspect ratio is maintained.

NOTE: If you want the system to use the maximum available window space, either resize the data window or click the Reset button.

6.5 - ZOOM BOX

In 2D & Image modes, you can also zoom into an area by drawing a Zoom Box. In both instances, hold down the primary mouse button and pull the cursor in a diagonal across the screen around the area that you are interested in.

- In 2D mode, the top and bottom edges of the zoom box demarcate the range of values that will be shown over the full height of the data-axis. Having drawn the zoom box, release the mouse button to perform the zoom operation. The minimum zoom width is 30 pixels.

NOTE: You may wish to perform a Rescale (see page 90) on data you have just zoomed. Rescale will plot all recorded data values that fall within the new, zoomed range of the x-axis against a newly calibrated data-axis. In this way you will be able to see peaks and troughs that may have been clipped off by your zoom box.

- In Image mode, release the mouse button to perform the zoom operation. The image will zoom to show the selected area in greater detail. The minimum zoom area is 30 x 30 pixels.

If you have selected **Always Maintain Aspect Ratio** you may find that an area slightly larger than the zoom box has been expanded. The system adds extra area as necessary so that the zoomed image accurately represents the height to width ratio of the individual pixels on your CCD-chip.

NOTE: To help the system zoom the area you require, draw the zoom box in similar proportions to the height and width of the image display.

6.6 - ZOOMING & SCROLLING

The following functions are available in data windows whilst in 2D & 3D Display modes:

- Zoom in
- Zoom out
- Scroll

6.6.1 - Zoom In & Zoom Out

On a data window in 2D or 3D display mode, pairs of **Zoom In:**  and **Zoom Out:**  buttons are provided on both the x- and data-axes of the trace.

These buttons allow you to stretch or shrink the scale (to cover a smaller or larger range) on either the x- or data-axis, creating the effect of zooming in or zooming out in either the vertical or horizontal dimension of the display.

6.6.2 - Scrolling

If you have stretched a scale by zooming, you can slide the scale to cover a different range, and the display will scroll in synchronization with the moving scale. Place the cursor arrow over the scale so that it changes to a finger flanked by arrows. Now, depressing the primary mouse button allows you to 'slide' the scale up and down (or left and right) and scroll the display.

If you place the finger cursor at either end of an axis you will notice that a single arrow appears beside it, indicating the direction in which the scale will slide automatically when you depress the primary mouse button: the display "fast scrolls" accordingly.

6.6.3 - Reset

Clicking the  button when a Data Window is open, returns the displayed data to its original configuration, thus undoing any adjustment to scale that you may have performed in accordance with the descriptions given in 'Zooming In', 'Zooming Out', 'Scrolling' and 'Rescale' (see [page 90](#) for more information on rescaling). Reset is available for all display modes.

6.7 - 2D DISPLAY MODE

To view data in 2D, either select 2D from the drop-down menu or click on the  button. Data is then displayed as an unlabeled trace, e.g.:

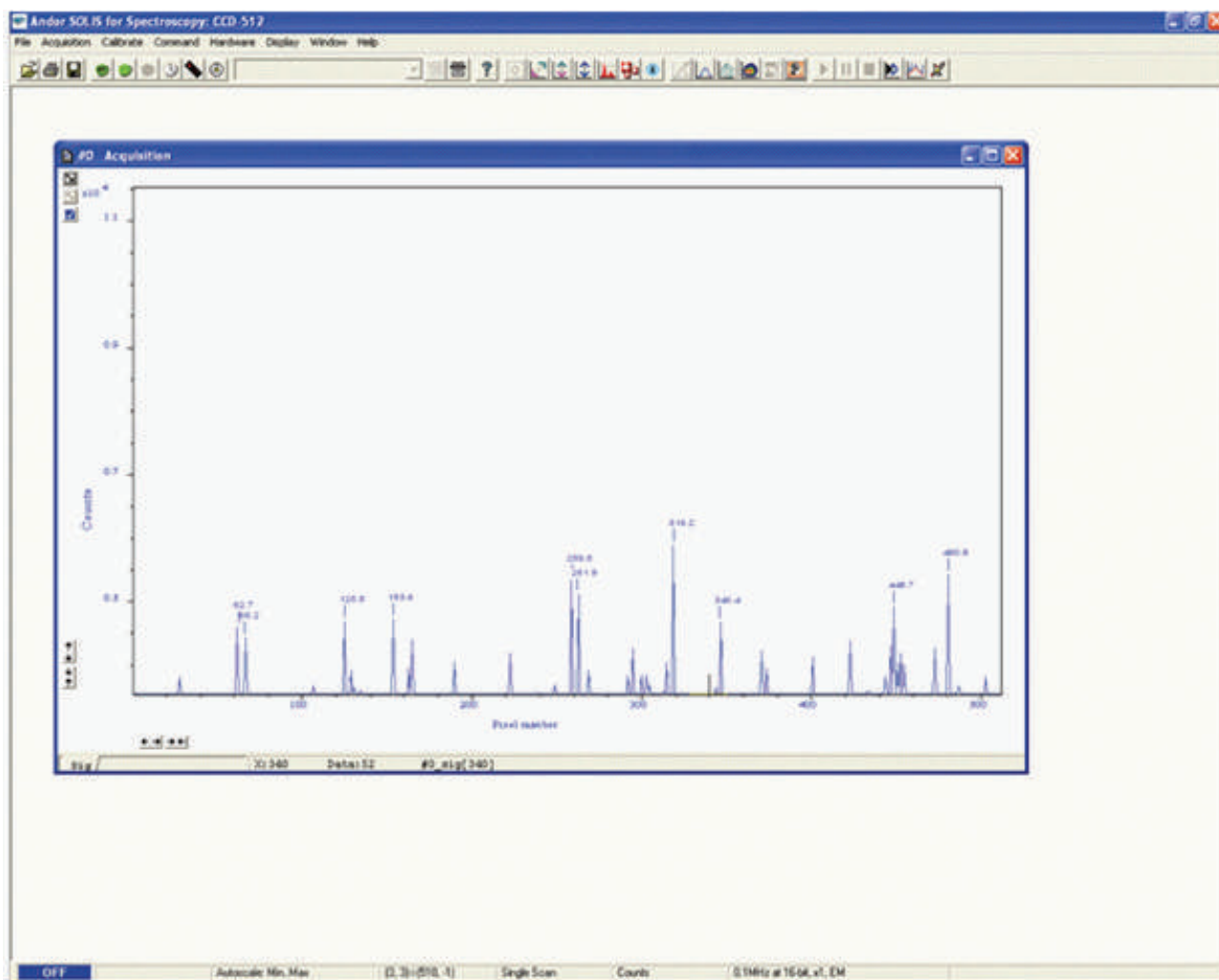

6.7.1 - 2D display mode preferences

The following options are available to view peaks when in 2D Display mode:

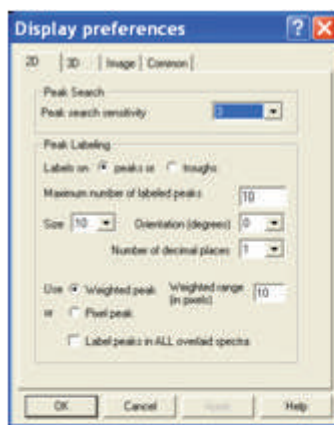

The display is similar to the following:

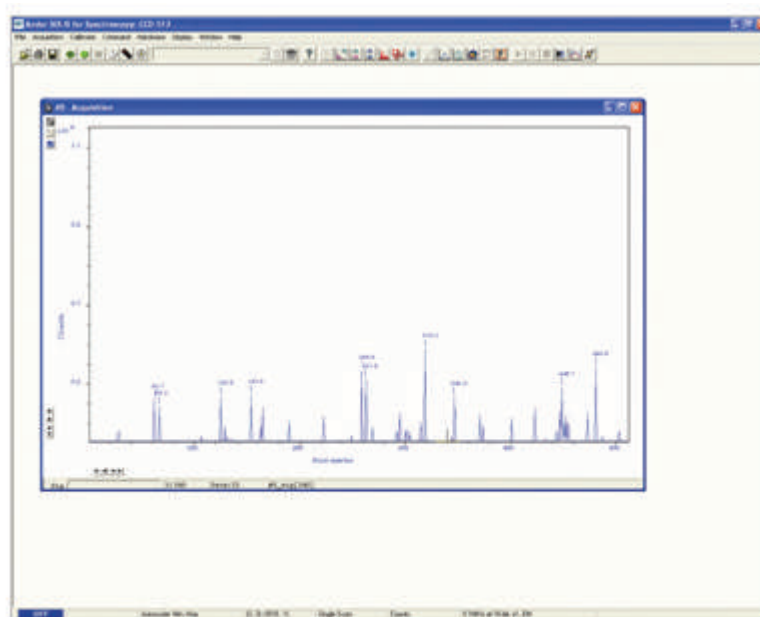

6.7.1.1 - PEAK SEARCH

6.7.1.1.1 - Peak Search Sensitivity

The Peak Search Sensitivity option Determines the manner in which the cursor moves between peaks/troughs when you key in **Ctrl + Right Arrow** or **Ctrl + Left Arrow**.

A low sensitivity (e.g. 1) means the system will find the most prominent peaks or troughs.

A high sensitivity (e.g. 5) means less obvious peaks or troughs will be found.

NOTE: This parameter relates only to Peak Search, not to Peak Labeling.

6.7.1.2 - Peak Labelling

6.7.1.2.1 - Labels on Peaks or Troughs

Lets you choose whether to mark the highest points (peaks) or lowest points (troughs) on the trace.

6.7.1.2.2 - Maximum Number of Labeled Peaks

Causes only the highest peaks or lowest troughs, up to the total number of peaks/troughs indicated, to be labeled automatically.

6.7.1.2.3 - Format Labels

Size, Orientation & Number of Decimal Places lets you format the peak labels.

For Orientation, 0° is horizontal; 90° vertical. You can have up to 4 decimal places in the label.

6.7.1.2.4 - Weighted Peak

Weighted Peak in combination with a Weighted Range (centered on the highest/lowest positioned pixel) lets the system calculate and label a weighted mean to represent the peak or trough.

NOTE: This feature works best on peaks or troughs which are symmetrical about the highest/lowest point.

6.7.1.2.5 - Pixel Peak

The system can label the Pixel Peak (the highest/lowest positioned pixel).

6.7.1.2.6 - Label Peaks in all Overlaid Spectra

You can also choose whether to label peaks in all overlaid spectra or to have peaks labeled only on the active trace. See **Overlay** on page 76.

6.7.2 - 2D with Peak Labeling

To label peaks automatically, either select 2D from the drop-down menu or click the  button. The data window display will change e.g. :

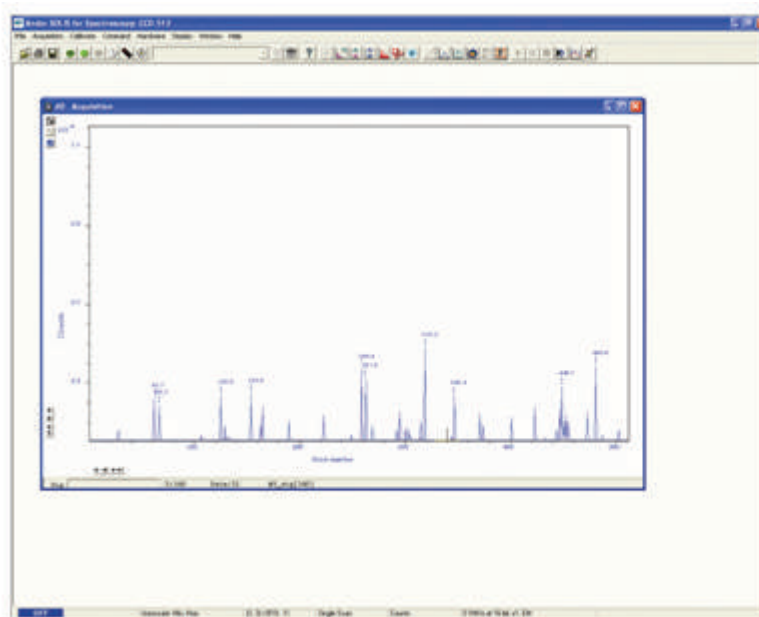

When labeling is selected, you can label a peak manually by double clicking it.

To remove a peak label, double click it again. If you switch off peak labelling (by clicking the  button), your manual labeling will be lost. **NOTE: To manually label peaks accurately, it is best to zoom in on the trace as described previously.**

By default, the x-axis will be calibrated in pixels (1 on the x-axis corresponds to the position of the first column of pixels on the CCD-chip, etc.). The data-axis will, by default, be calibrated in counts. For details of how to change the calibration on the x-axis, please refer to **Section 8**.

- If you have acquired data in an imaging mode you will be able to view the data from each track on the CCD-chip (or row, if you have acquired a Full Resolution image).

To view the traces from each track or row individually, use the scroll bar on the data window. The numeric display on the bottom edge of the data window will indicate which track or row you are currently viewing. **NOTE: If there is only one track of data, no track or row number will be displayed, nor will there be a scroll bar.**

- If you have acquired data as a Kinetic Series, you may also use the scroll bar to move between the members of the series. The display on the bottom edge of the data window will indicate which member of the series you are currently viewing.

To read off a data value, click on the trace to position the cursor on the point of interest (you may need to use the left and right arrow keys on your keyboard to position the cursor precisely). The numeric display on the status bar along the bottom edge of the data window will indicate the corresponding x- and data-values.

6.7.3 - Overlay

The ability to Overlay data traces is useful, if you wish to compare several traces on the same axes. You can display up to nine 2D traces simultaneously in the same data window. The data window in which you intend to display the overlaid traces, must be in 2D display mode. Only the data which was originally in that data window, can be saved or modified when the data window is active. You cannot, for instance, use the data window to calibrate traces that have been added as overlays. The data window from which the 2D overlays are taken, can be in any display mode. **NOTE: The examples shown for Overlay functions are taken from an Andor Newton camera setup, but the principle is exactly the same.**

- To add an overlay, first obtain a live signal, e.g.:

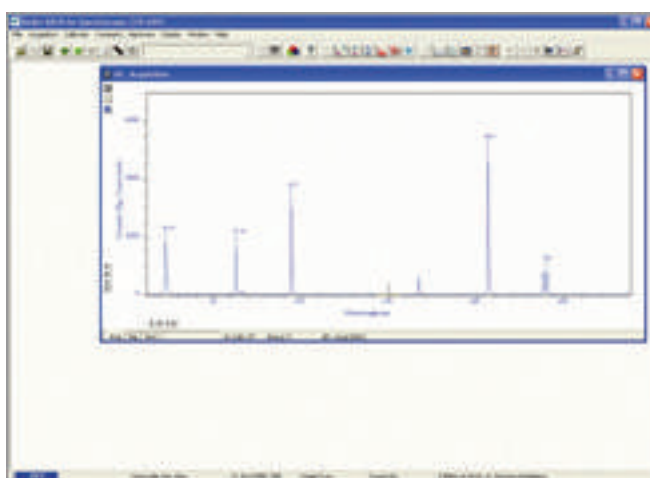

- Then save the image as a SIF file, e.g.:

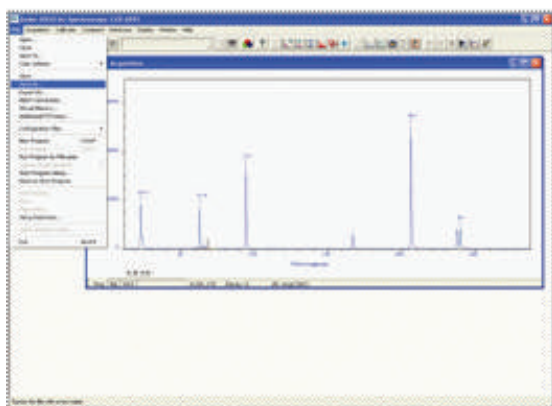

- Take some further acquisitions (this is normally done with different parameters set) and save these as SIF files again. The examples below show the same source as above but acquired in different modes:

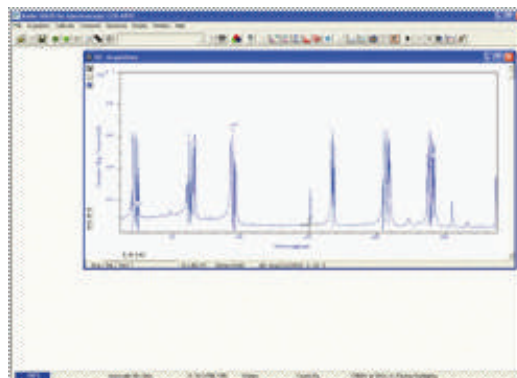
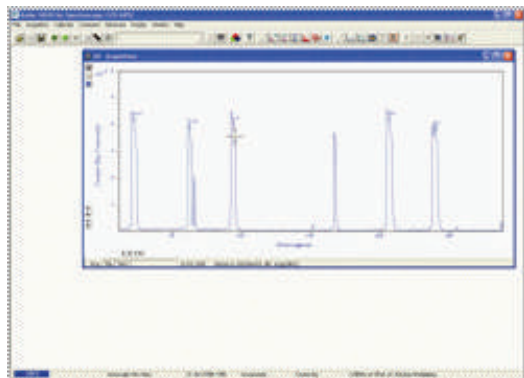

- When you have taken all the reference acquisitions required, keep the last live acquisition window active and open the previously saved SIF files.
- Click the  button on the live #0 Acquisition data window and the **Add Another Trace To Display** dialog box appears:

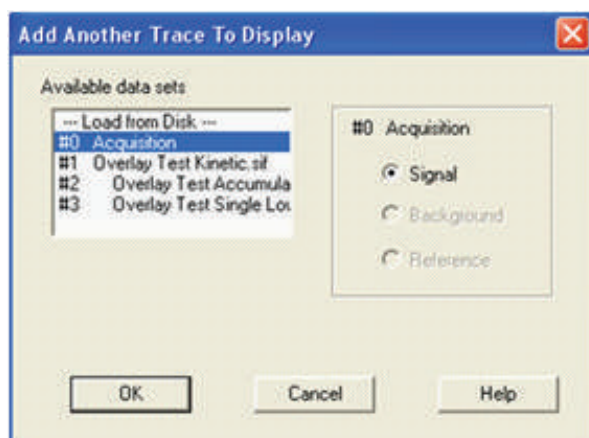

The selection list displays the names of data sets that are already being displayed in a data window. Alternatively, you can select files previously stored by selecting the **Load from Disk** option and choosing the appropriate file or files, e.g.:

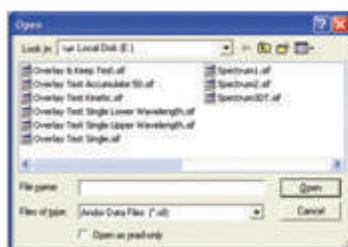

Buttons also let you specify **Signal**, **Background** or **Reference** data (if these are contained in the data set you have selected for overlay).

- Once you have selected the required file(s) and have clicked **OK**, the display will change, e.g.:

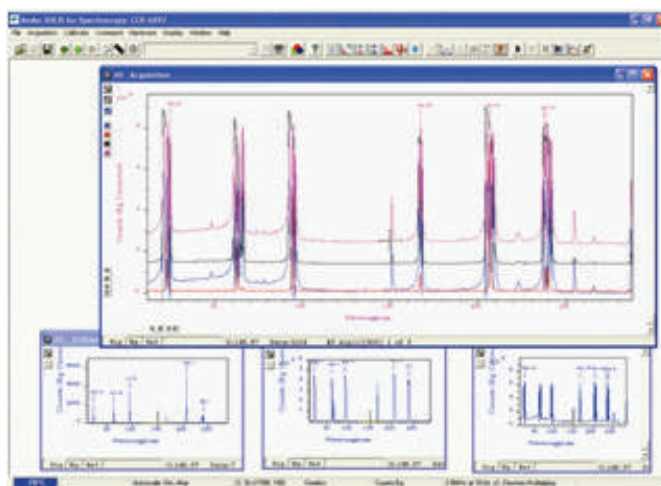

NOTE: You can add up to a maximum of 8 overlays to your original data trace.

The original data trace is always displayed in blue. Each new overlay appears in a unique identifying color and the **Active Trace** button is displayed on the left in the same color.

- To manipulate the trace you want, click on the Active Trace button corresponding to the color of the trace you wish to work with. The values on the horizontal and vertical axes will change to correspond to the Active Trace and will be presented in the same color as the trace itself.
- Once active, a trace can be manipulated the same manner as any **2D Display**. If you try to add too many traces, you will be prompted with the following message:

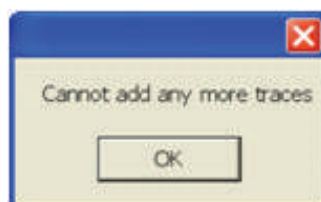

6.7.3.1 - Overlay and Keep

The **Overlay and Keep** feature is used only with 'live' data acquired into the #0 Acquisition Window. If you have just acquired data that you think you might want to compare with subsequent data, click the button. In the #0 Acquisition window, the live trace will appear in blue but overlaid with a copy in red and the new data window containing the selected data will be shown minimized at the bottom of the screen, e.g.:

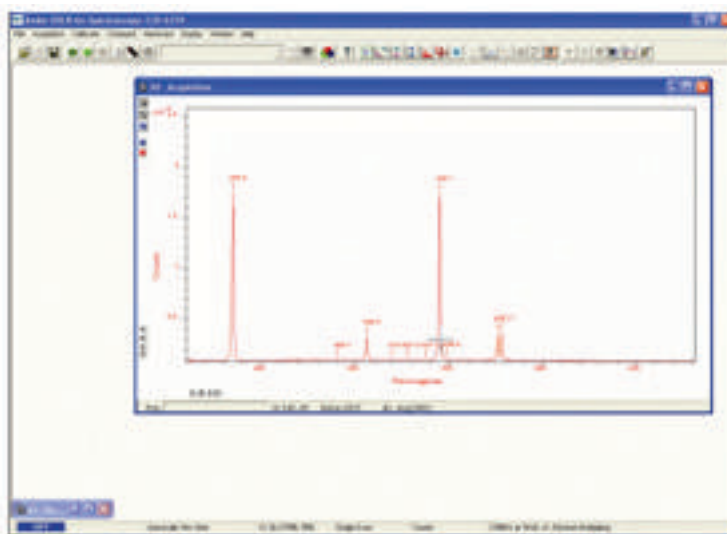

You can display the #1 data window again by clicking on the minimized window, e.g.:

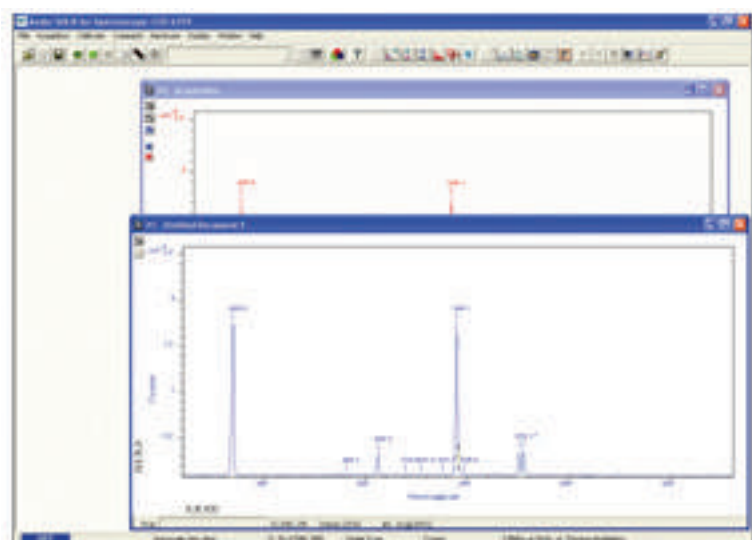

If required, you can then save this new data window to file for subsequent analysis.

6.7.3.2 - Scale to Active

If you have overlaid a number of traces, the **Scale to Active** option becomes available on the **Display Menu**, e.g.:

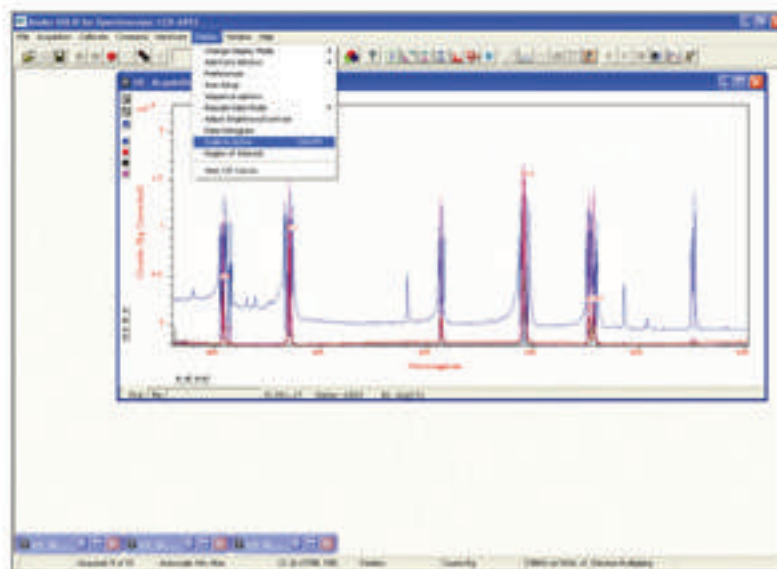

When **Scale to Active** is selected, all the data traces in your data window will be plotted against the scales of the active trace, e.g. for the red trace:

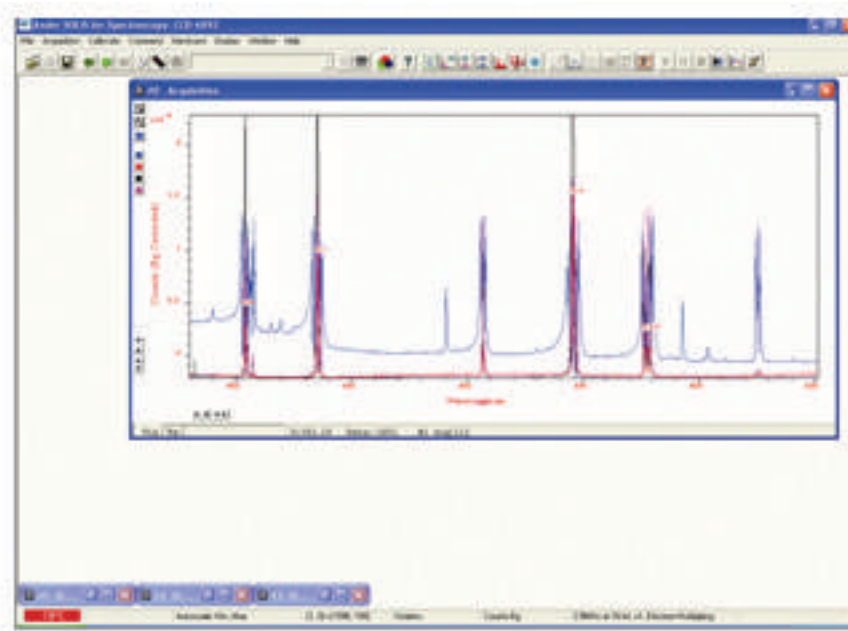

Vertical axes will be rescaled even if the units do not match those of the active trace.

6.7.3.3 - Remove Overlay

If you want to remove an overlay, first make sure that it is the Active Trace then click the  button. If necessary use the Active Trace buttons to select a new active trace.

6.7.4 - Baseline Correction

With Baseline Correction, a series of points on a signal are selected through which a smooth, continuous reference is obtained. This reference is subsequently subtracted from the original signal and the resultant spectrum saved to a new data set.

To select the function, click the  button and the **Baseline correcting** dialog box appears, e.g.:



The user can now enter and define customized baselines. The values to be subtracted are entered against individual pixel numbers in the dialog box. The user can select whether to fit the data using polynomial or cubic spline. The user can also select where the **Corrected** and **Baseline** data are stored. When the necessary parameters have been set and the **Apply** button is clicked, other data windows will be generated as defined by the user, e.g.:

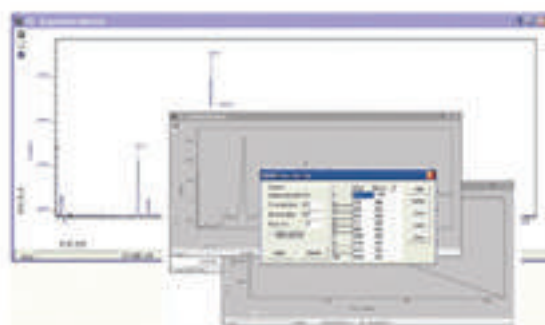

Window #0 will show the raw data as acquired during the last acquisition, by default window #2 will show the profile of the customized baseline to be subtracted off the raw data and window #1 will show the baseline corrected data i.e. #0 - #2). The window number labels of the customized baseline profile and corrected data can be adjusted by changing the numbers detailed in the Baseline correcting dialog box.

6.8 - 3D DISPLAY MODE

If you have acquired data in Imaging mode or as a Kinetic series you can view the traces taken from all the rows or tracks on one set of axes in a data window.

Select the 3D option from the Change Display Mode option on the Display menu, or click the  button. A data window will appear e.g.:

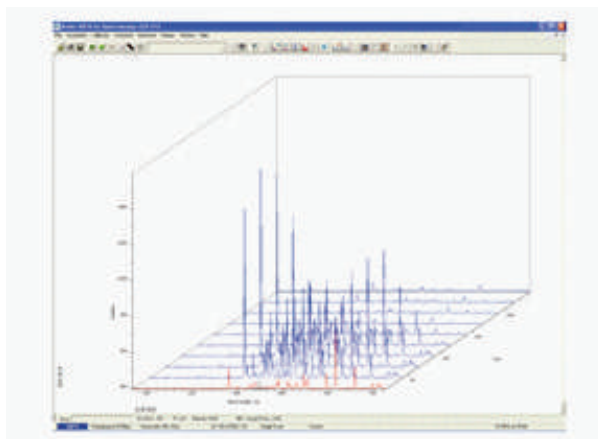

Along with the x-axis (calibrated by default to represent pixels across the CCD-chip) and the data-axis (calibrated by default in counts), you now see a 3rd (or y-axis) calibrated in rows or tracks, depending on the acquisition mode you have selected.

To read off a data value on a particular trace, use the scroll bar on the data window to move the trace into the plane delineated by the x- and data-axes, and click on the trace to position the cursor on the point of interest (you may need to use the left and right arrow keys on your keyboard to position the cursor precisely).

The numeric display on the status bar along the bottom edge of the data window will indicate the series member on which the cursor is positioned ('Kinetics'), along with the corresponding x- and data-values.

If your data set contains a series of images (each of which may represent data acquired in Kinetics Mode) you will notice that the data window has two scroll bars, placed end to end. The upper scroll bar allows you to move between the members of the series, while the lower scroll bar allows you to view the traces that make up the particular member of the series.

NOTE: Zooming, Scrolling and Reset functions are the same as for 2D mode.

6.8.1 - 3D display mode preferences

When 3D display mode is selected, the following options are available from the **Display Preferences** dialog box:



You can display multiple tracks either **Overlaid**:

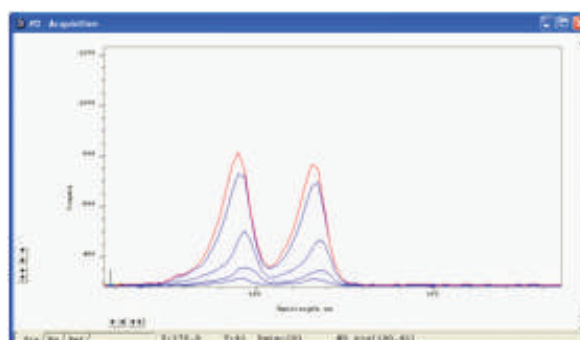

or **Stacked**:

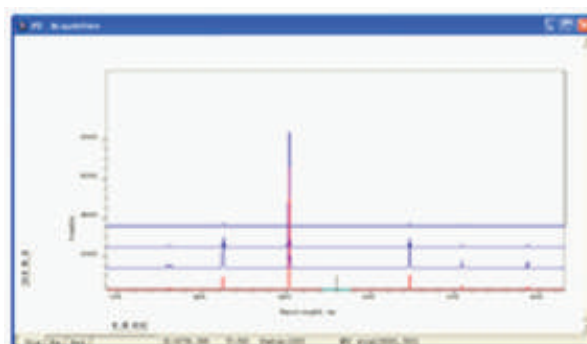

or at 45 degrees:

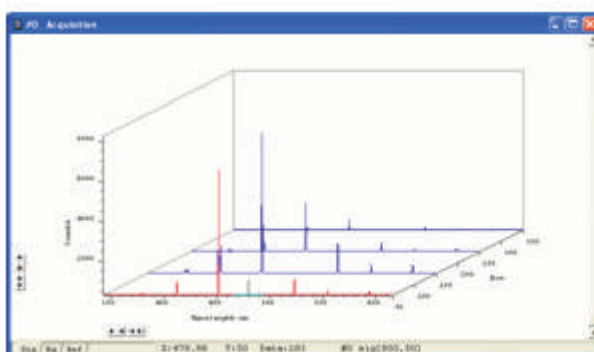

6.9 - IMAGE DISPLAY MODE

Data acquired in **Imaging** mode can be viewed as an image in a data window.

Select the **Image** option from the **Display** drop-down menu or click the  button and an image will appear, e.g.:

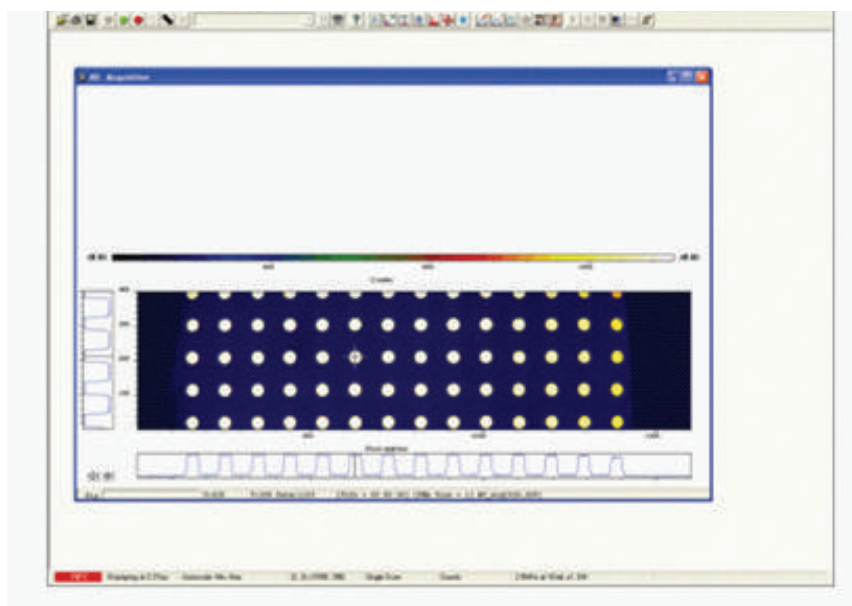

The cross-hair moves to any point on the image that you click. See also **Show 2D cross sections** (page 86) and **Large Cursor** (page 87)

The data value for the point, along with the pixel numbers on the x- and y-axes that identify the point, is displayed on the bottom edge of the data window.

NOTE: If your data set contains a **Kinetic Series**, each member of which has been acquired in an **Imaging mode**, you will notice a **vertical scroll bar** that allows you to move between the images that make up the series. The **number of the member of the Kinetic Series** is also displayed on the bottom edge of the data window.

6.9.1 - Image display mode preferences

When the Image tab on the Display Preferences dialog box is selected, the following options are made available:

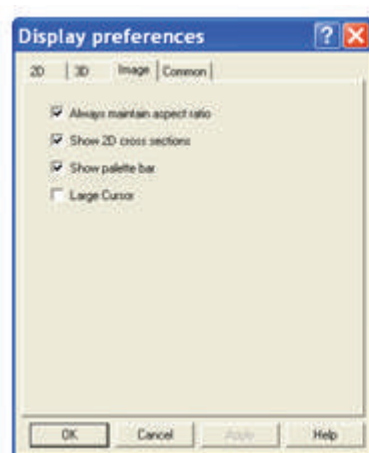

6.9.1.1 - Always maintain aspect ratio

- When the Always Maintain Aspect Ratio option is ticked, 2 special buttons appear on the data window as shown:



Clicking these buttons causes the scales on both the vertical and horizontal display axes to stretch or shrink proportionately to one another, giving the impression of zooming in towards or zooming out from the image, while maintaining the original proportions of the image.

- When the Always Maintain Aspect Ratio option is deselected, the following buttons appear instead of those shown previously:



Clicking these buttons allows you to stretch or shrink the scale on either the x- or y-axis.

This creates the effect of Zooming In or Zooming Out in either the vertical or horizontal dimension.

6.9.1.2 - Show 2D cross sections

When Show **2D cross sections** is selected, 2D Side Traces are displayed parallel to the vertical and horizontal edges of the display area, e.g.:



The long edge of each Side Trace is calibrated in the same units as the corresponding edge of the display. Plotted against the unmarked 'short edge' of the vertical and horizontal Side Traces are the data values taken (respectively) along a vertical or horizontal line running through the cross-hair. See **Large Cursor** below also.

NOTE: If you are displaying data in Image Display Mode and resize the Data Window, so that it occupies only a small screen area, the system removes the Side Traces and the Zoom In and Zoom Out buttons. In this 'display only' mode the Zoom Box is also disabled. 'Display only' is of benefit if you want to review many Data Windows simultaneously in Image display mode.

6.9.1.3 - Show palette bar

Show palette bar causes the palette and it's control to be displayed or removed e.g.:

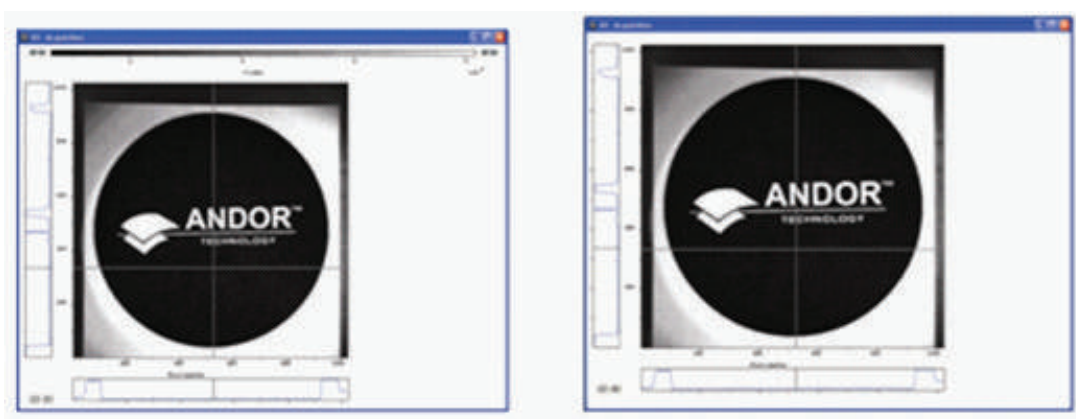

The arrow buttons at either end of the palette bar can be used to adjust the manner in which values are mapped against colors, and so change the brightness and contrast of the image. See next page for further details of the Palette Bar.

6.9.1.4 - Large Cursor

When the **Large Cursor** option is selected, the cross-hairs run the full height and width of the display, e.g.:

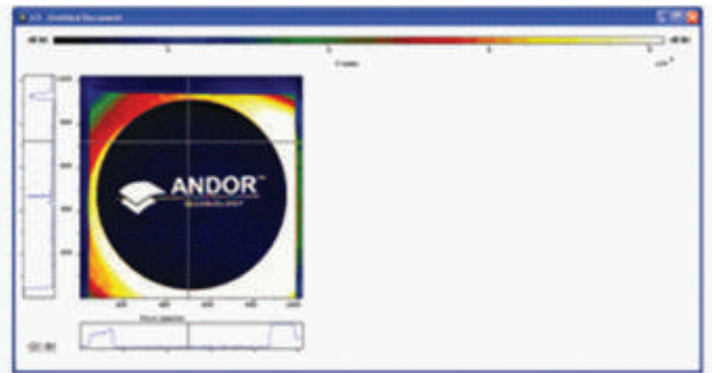

This makes it easier to identify the corresponding points on the Side Traces.

6.9.2 - Palette bar

The Palette bar:  runs across the top of the data window. This shows the full palette of grays or colors available in each color mode. The palette is graded so that lower data values correspond to the darker tones to the left of the palette, and higher data values correspond to the brighter tones to the right of the palette.

- The arrows to the left of the Palette bar on the data window allow you to adjust the minimum distinguishable data value (i.e. min, the value at which the Palette bar becomes black), e.g.:



- The arrows to the right of the Palette bar on the Data Window allow you to adjust the maximum distinguishable data value (i.e. max, the value at which the Palette Bar becomes white), e.g.:

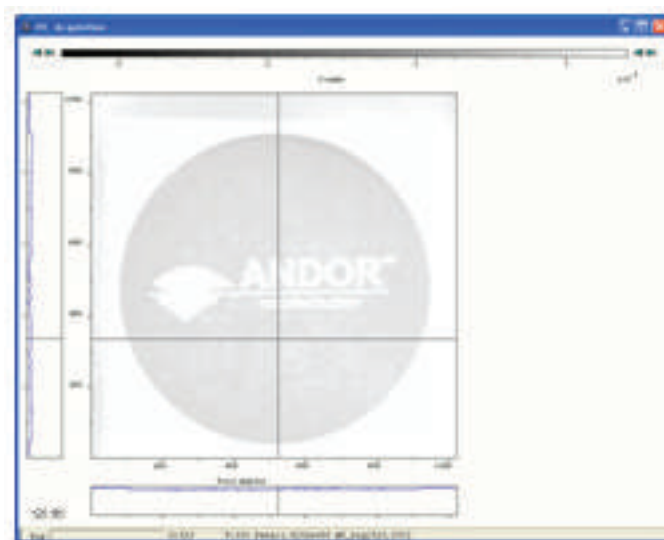

The scale on the Palette bar is calibrated in your chosen data units. By default, the full range of colors/grays is correlated with the full range of data in your data set. This is known as **'Rescaling'** (see **Rescale** on page 90).

Adjusting the Brightness & Increasing and Decreasing Contrast later in this section explain how you can use these controls to change the brightness and contrast of the display.

6.9.3 - Selecting Color/Grayscale

The display appears initially in grayscale, e.g. :



Clicking on the  button causes the data window to cycle through the following modes:

- **False Color**, e.g.



- **Iterated Grayscale** (a small sequence of grays is repeated at intervals to cover the same range of data as grayscale), e.g.:



6.9.4 - Rescale

When a data window is open and you click on the  button on the button bar of the Main Window, the system displays against an appropriate data scale all data that falls within the range selected on the x-axis.

In Image Display Mode, it will also be displayed in appropriate colors or grayscale tones.

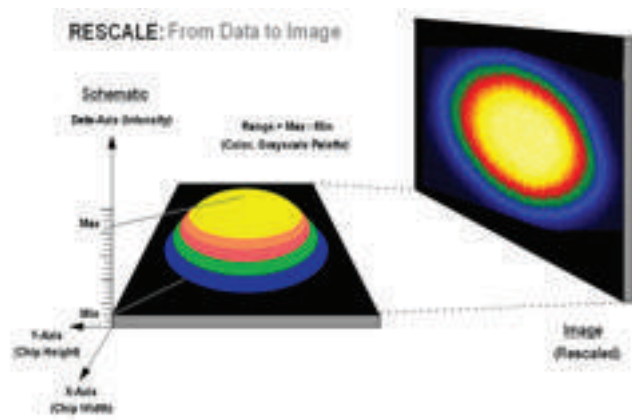

From the **Rescale Data Mode** menu of the **Display** drop-down menu, you can also select the maximum number of counts that can be recorded for a single pixel, your rescaled data distinguishes values between the following parameters:

- Minimum and Maximum: **(Min..Max)**
- Zero and Maximum: **(0..Max)**
- Zero and 65535: **(0..65535)**
- Minimum and 65535: **(Min..65535)**
- Custom Setting: When **Custom..** is selected, the **Custom Autoscale** dialog box appears, e.g.:

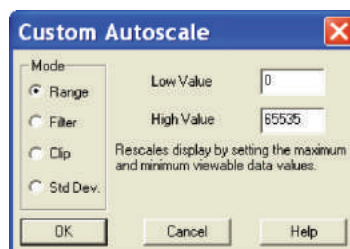

Autoscale Acquisition performs a similar function for the display of data as they are being acquired. It can be selected from the Acquisition drop-down menu, or by clicking the buttons on the buttons:

 = **On**

 = **Off**

or by pressing **F6** on the keyboard.

Rescale is available for all the Display Modes. The following comments take rescaling in Image display mode as a specific example. Image display mode is used to display the members of a Kinetic Series as an image (each member of the series forms a row of the image.)



The computer rescales your display by default. The full available palette of colors/grays is correlated with the full range of data you have acquired.

When it rescales in Image display mode, the computer defaults to Minimum (Min) and Maximum (Max) and scales the available number of colors to the range.

Alternatively, depending on the rescale submenu item you have selected, the range may be between 0 and Max, or between 0 and 65535.

For various reasons (e.g., a cosmic ray may produce a data 'peak' that is unrepresentative of data levels generally), rescaling may not adequately illustrate the features of the data you are most interested in. To emphasize or de-emphasize particular features, you can adjust the contrast and/or the brightness of the display. See Increasing & Decreasing Contrast and Adjusting the Brightness that follow.

6.9.5 - High & Low Contrast Overview

Assume your original data are rescaled.

Data-Axis

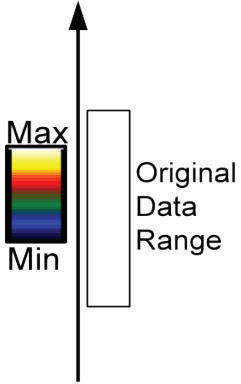

To achieve high contrast, the computer scales a smaller range of data with the same number of colors as it used for rescaling.

Any data value greater than the maximum in the displayed data range is represented by the brightest color (white). Any data value lower than the minimum in the displayed data range is represented by the darkest color (black). Now only a fraction of the original data range is represented by the total number of colors.

High Contrast Decreasing the displayed data range produces high contrast.

Data-Axis

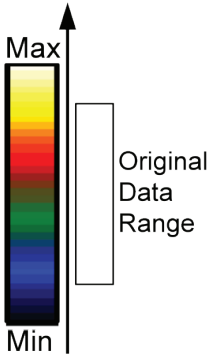

To achieve low contrast, the computer scales a larger range of data with the same number of colors as it used for rescaling. Thus the original data are represented by a smaller range of colors.

Increasing the displayed data range produces low contrast.

Low Contrast

6.9.5.1 - Increasing & Decreasing Contrast

You can use the pairs of left-right arrows at either end of the Palette Bar to increase or decrease the displayed data range (i.e. “shrink” or “stretch” the scale on the palette) and thereby alter the contrast of the data shown in Image display mode. You can also use the + and – keys to do the same function.

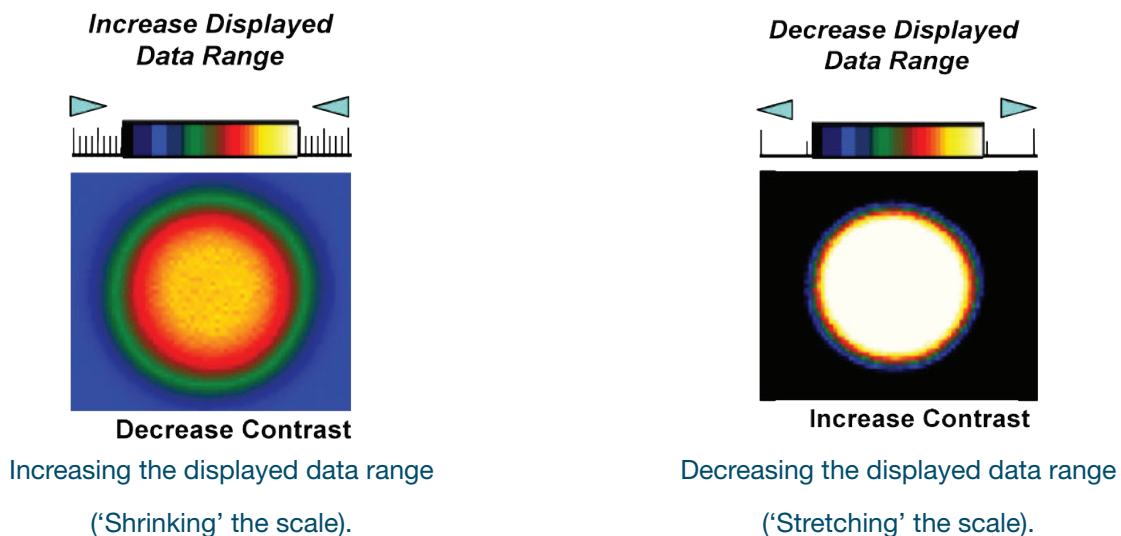

By holding down the left-right arrows at either end of the Palette Bar you can alter the minimum and maximum values in the displayed data range independently of each other, and so adjust the contrast to the level you require.

As you hold down the arrows (place the cursor over an arrow button and hold down the primary mouse button), observe carefully how the scale changes and how the displayed data range is affected. If you wish to undo your changes, use Rescale.

NOTE: When the left-right arrows are held down for a time, you will see the display flash periodically as the system performs the contrast adjustment. These flashes occur as the system refreshes the color palette to cover your new displayed data range. Hold the arrows down until you reach your required contrast level.

6.9.6 - Brightness Overview

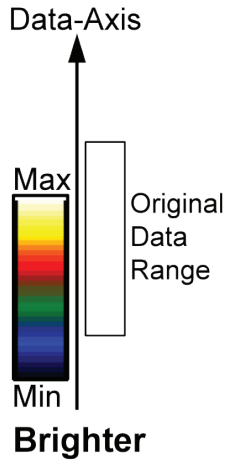

To make the data shown in Image display mode brighter, the computer uses the same number of colors as it used for rescaling to scale lower data values.

Thus any data originally represented by darker colors are now represented by brighter colors.

To make the data shown in Image Display Mode darker, the computer uses the same number of colors as it used for rescaling to scale higher data values.

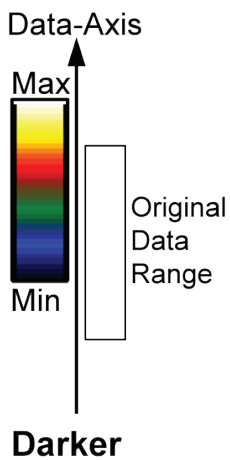

Thus any data originally represented by brighter colors are now represented by darker colors.

NOTE: If you wish to undo your changes, use Rescale.

6.9.6.1 - Adjusting Brightness

You can alter the brightness of the data shown in Image display mode by moving the displayed data range so that it covers higher or lower data values.

To move the displayed data range, place the cursor on or just below the Palette Bar (the cursor changes to a finger) and, holding down the primary mouse button, 'slide' the scale on the palette to the left or right.

Sliding the scale to the right means that the displayed data range covers lower data values (the numbers on the scale decrease).

The display then becomes brighter as shown on the right.

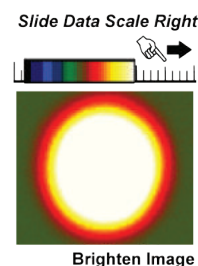

Brighten Image

Sliding the scale to the left means that the displayed data range covers higher data values (the numbers on the scale increase).

The display then becomes darker as shown on the right

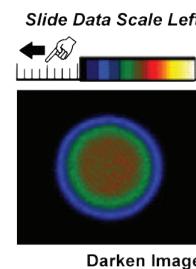

Darken Image

NOTE: When you slide the scale, you will see the image flash periodically as the system performs the brightness adjustment. These flashes occur as the system refreshes the color palette to cover your new displayed data range. Continue to slide the scale until you reach your required brightness level.

6.10 - IMAGE & DISPLAY DATA RANGES SUMMARY

In summary, the general rules that follow apply:

- Larger displayed data range = **Less contrast**
- Smaller displayed data range = **Greater contrast**
- Displayed data range covers higher values = **Darker display**
- Displayed data range covers lower values = **Brighter display**

6.11 - DATA HISTOGRAM

The Data Histogram dialog Box is launched either by clicking on the  icon on the Main Window, or selecting Data Histogram from the Display drop-down menu. This tool allows you to plot a histogram, or graph, between the maximum and minimum data points in the displayed range. It also contains a filter drop down menu, which allows for more accurate analysis and presentation of data values.

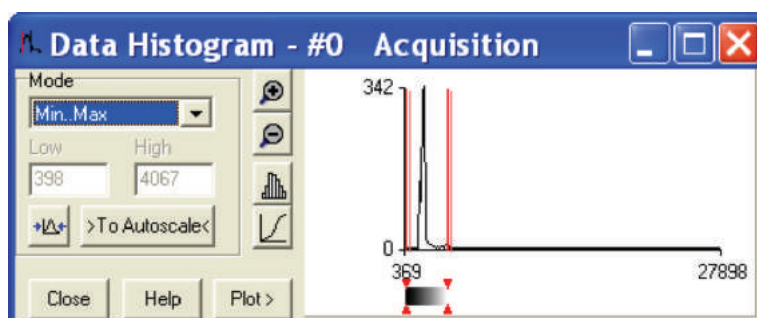



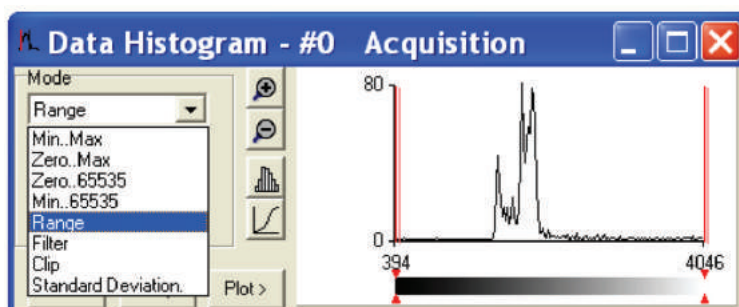

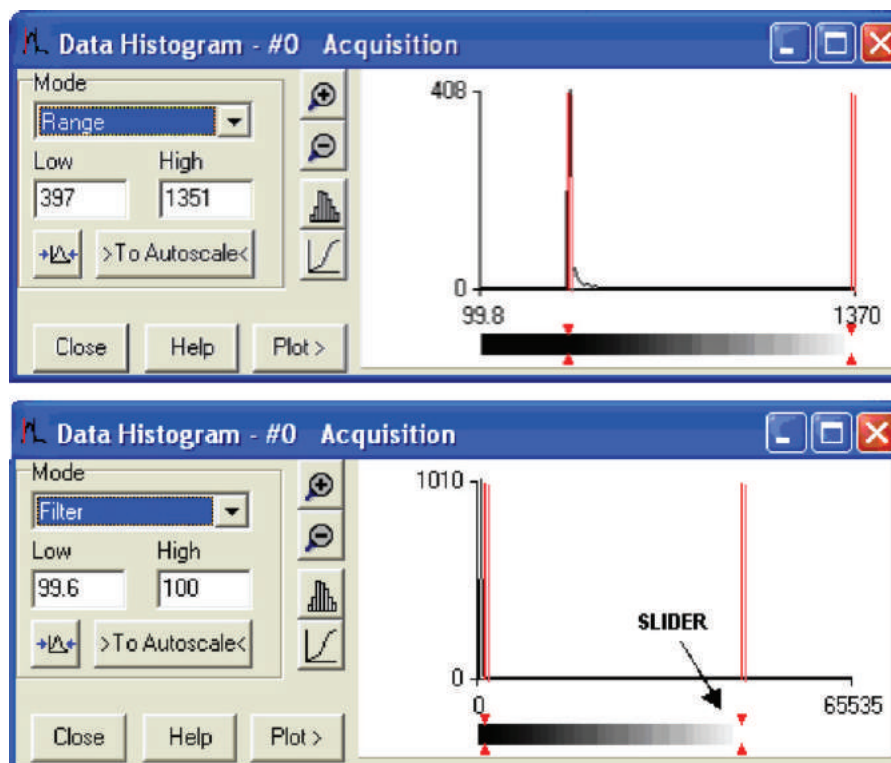

By clicking on an open data window, its histogram will be displayed on the Data Histogram dialog. When plotting the histogram, the focus is transferred to the new data window and the displayed histogram is that of the plotted histogram. The data from which the histogram is displayed is indicated on the title bar of the Data Histogram dialog. To return the focus on the original data, click on the original data window. Modes to view specific areas of spectra can be selected through the drop-down menu:



Values can be modified either by typing in the new values in the Low and High text boxes or by dragging the red arrows and bars below the histogram, e.g.:



- **Update:** any change on the mode and/or the Low/High values is updated when the Update button  is clicked.
- **Autoscale:** after clicking the  button, acquisitions that follow will use these scaling settings as default.
- **Expand to bounds:** clicking on the  button zooms in on the histogram.
- **Zoom Out:** clicking on the  button zooms out on the histogram.
- **Bar Chart:** clicking on the  button toggles between x-y and bar chart histogram display.
- **Cumulative:** clicking on the  button toggles between cumulative (integral) and non-cumulative histogram display.
- **Plot:** clicking on the  button plots the histogram into a data window.

6.12 - REGION OF INTEREST

Region of Interest (ROI) is an important post-acquisition tool, used for quantitative analysis and it can be selected either by clicking the  button or selecting **Region of Interest** from the Display drop-down menu. When ROI is selected, the following dialog box opens:

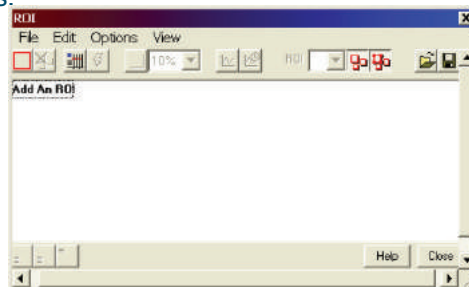

Click on the **Add An ROI** text or position your cursor on the image, and an ROI will be added, e.g.:

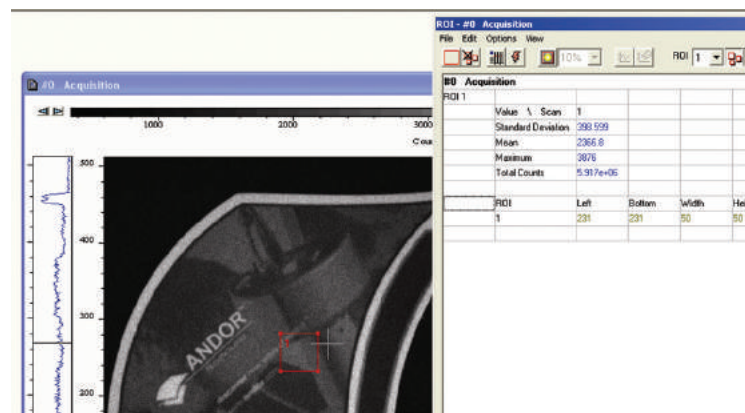

The area covered by the ROI can be altered by dragging any of the four corners in or out as required.

You can also select and draw multiple ROI's onto your image then use the ROI data set to compare the values obtained, e.g.:



There are 3x buttons in the bottom-left of the ROI dialog box:



- Clicking the **View** button will present and group your ROI data, according to each individual ROI region selected on the image. It will also display the pixel co-ordinates of all the ROI's for that scan, e.g.:

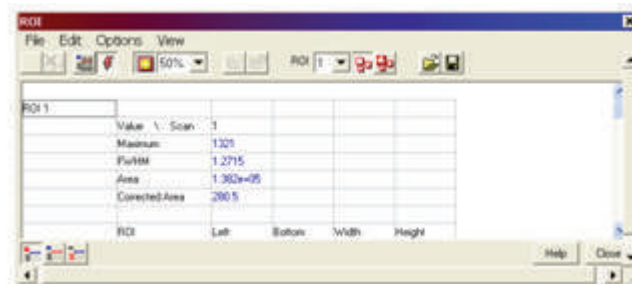

- Clicking the **Scan** button will present and group your ROI data, according to individual data scans. It will also display the pixel co-ordinates for all the ROI's for that scan, e.g.:

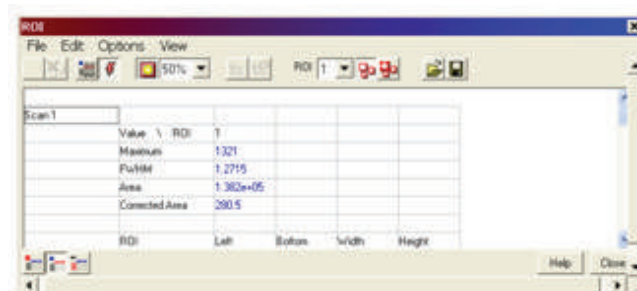

- Clicking the **Property View** button will present and group your ROI data, according to value regions, i.e. Mean, Range and Standard Deviation. It will also display the pixel co-ordinates for all the ROI's for that scan, e.g.:

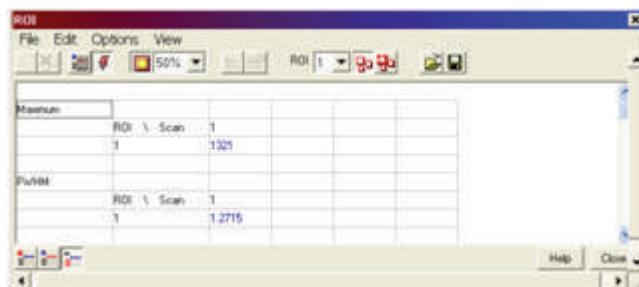

The ROI can be switched on and off by clicking the  button. When Show ROI is selected on, the selected ROI will be displayed and outlined by red boxes, e.g.:

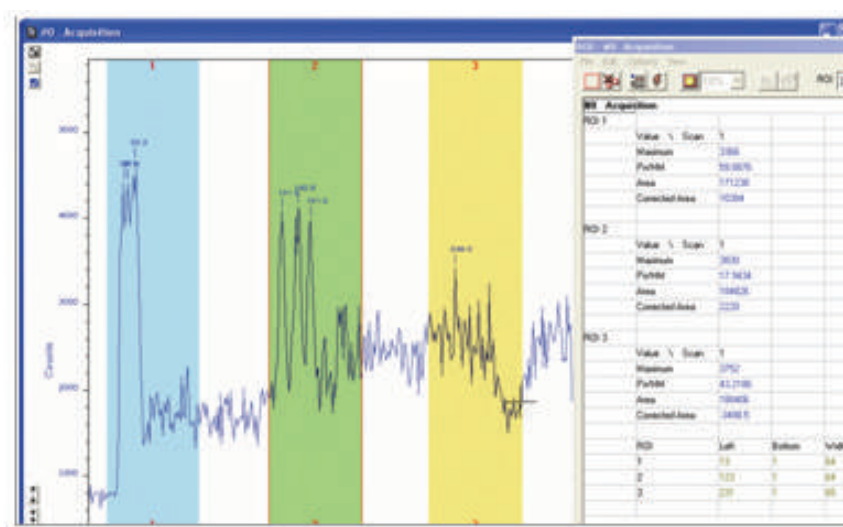

When Show ROI is selected OFF, the red ROI boxes are hidden.

NOTE: When Show ROI is selected On, it is not possible to position the Cross Hair cursor on the image to perform Zoom In or Zoom Out functions. The Edit ROI function is only available when Show ROI is selected On.

To activate, click on the  (Edit ROI) button. You can then change the size and location of the ROI's.

NOTE: When the Edit ROI tool is selected OFF, the red ROI boxes are locked and cannot be altered. This is useful tool to prevent accidental interference with ROI's.

The current ROI (including the ROI data set) can be deleted by clicking on the  (Delete current ROI) button.

6.12.1 - ROI Counter



This identifies the current active ROI. It can also be used to select and isolate a particular ROI, which can be a useful tool, e.g. if two ROI's are overlapping or are layered on top of each other. By clicking the down arrow, you can also see how many ROI's are currently defined.

6.12.2 - Hot Spot Approximation

This can be used to take a selected percentage of the highest data values within a given ROI.

To select, click on the  button, then select the % required from the drop-down menu. For example selecting 50% will give you the mean value for the top 50% of pixel values within the ROI.

6.12.3 - Recalculate

To recalculate the values in the ROI window, click on the  button.

6.12.4 - Live Update

You can receive and calculate ROI data, while the system is acquiring a Kinetic Series or running in Real Time Mode.

To select Live Update, click on the  button. The software is then able to acquire data and at the same time calculate and tabulate ROI data.

6.12.5 - Maximum Scans

When **Maximum Scans** is selected from the **Options** drop-down menu of the ROI dialog box, the **Scan Limit** dialog appears, e.g.:

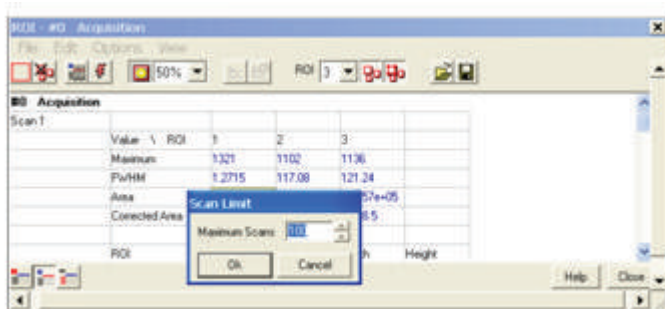

You can then enter the length of the history buffer you require (i.e. the number of previous values stored when acquiring in Real Time Mode with the Live Update feature enabled).

NOTE: This defaults to 100 and can be modified for longer series.

6.12.6 - Plot Series

Select any data value for a particular ROI and series position and the following buttons become available:



Clicking on these buttons will create a new dataset window displaying the currently selected property values plotted against series position or time.

6.13 - TIME STAMP

When the  button is clicked, the **Display preferences** dialog box opens, e.g.:



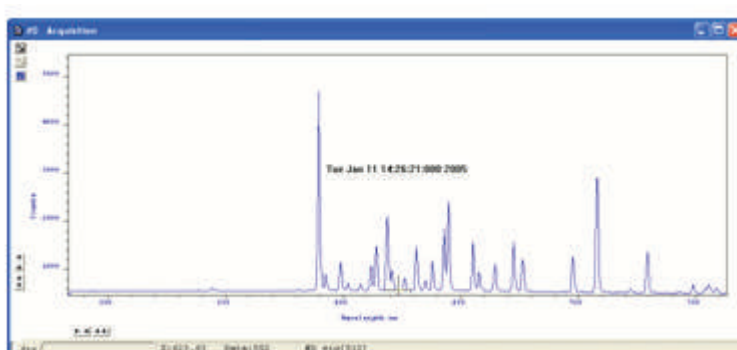

The Time Stamp feature allows you to add to the display, the time at which the acquisition (or each scan in a kinetic series) occurred, e.g.:



- Time & date information, or time relative to the start of the acquisition can be displayed by selecting **Enabled**, then selecting the appropriate option in the **Style** drop down list.
- The position of the time stamp within the display can be set by adjusting the Vertical & Horizontal Alignment controls.
- The color of the text can also be changed.
- The time can be made to print on a solid background by de-selecting Transparent.
- To remove the Time Stamp from the display de-select Enabled.

6.14 - PLAYBACK

After a Kinetic series acquisition has been taken, it can be played back again for analysis.

- To replay, click the  button and the acquisition will display again as taken
- To pause, click the  button
- To stop, click the  button

Playback autoscale performs a similar function to Autoscale acquisition and is selected from the button on the top of the main window, i.e.:

 = On

 = Off

The sequence can also be viewed with different parameters set.

Select Sequence options from the Display drop-down menu and the **Sequence Setup** dialog box appears, e.g.:



Select the parameters as required, click **OK**, then playback the sequence as normal.

NOTE: This can be exported as an MPEG or other similar file for use in presentations, etc. Please refer to Section 7 for further details on Handling Files

SECTION 7 - HANDLING FILES

7.1 - MENU OPTIONS

The File drop-down menu on the Main Window has the following options:

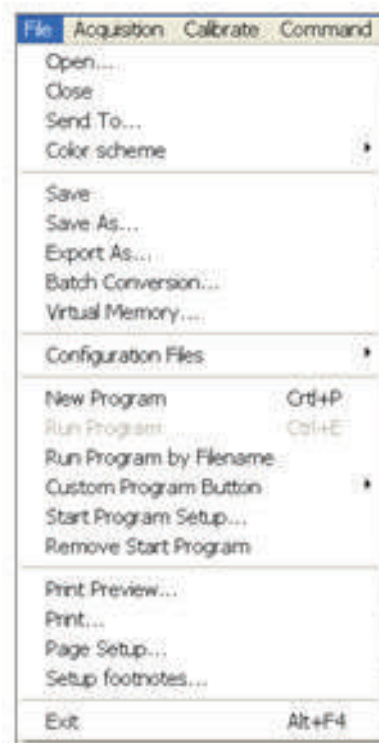

Some of the options available are typical 'Windows' facilities to Open, Save, Print files, etc., but some are specific to Andor Solis to let you create or run programs.

7.1.1 - Open

Selecting **Open...** from the drop-down menu or clicking on the  button opens a standard dialog box, e.g.:

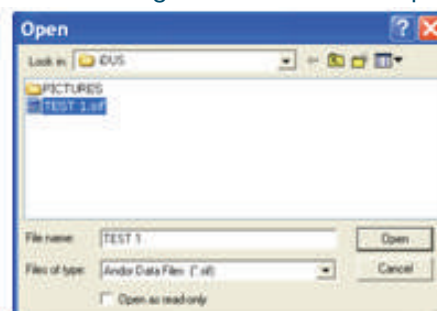

If you select a Data file (.sif), the system launches a data window with the appropriate file displayed, e.g.:

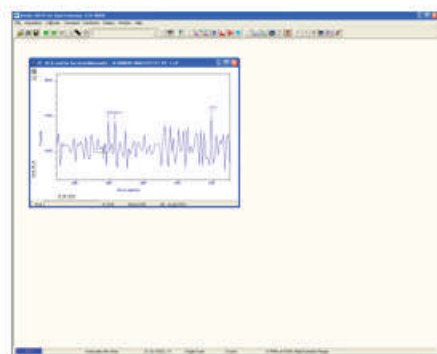

If you open a Program file (.pgm), the system launches a Program Editor window and makes available a selection of editing tools on the Main Window, e.g.:

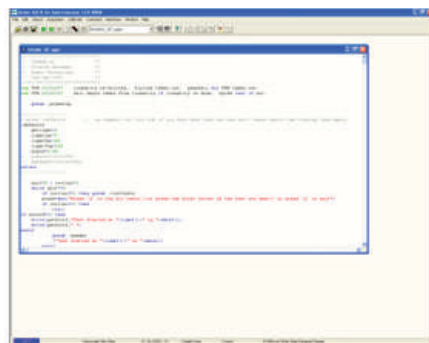

7.1.2 - Close

Close removes the active Data Window or Program Editor Window from the Main Window. You will be prompted to save any unsaved data to an appropriate filename.

7.1.3 - Save

Save or  stores the contents of an active and previously saved Data Window or Program Editor Window under the current filename.

7.1.4 - Save As

Save as... launches the Save As dialog box, which lets you save the contents of an active Data Window or Program Editor Window under a filename and in a directory of your choice.

NOTE: If data is saved as a .sif file, the information contained within file information is saved. If the data is exported to another file type, the information within file information is lost.

7.1.5 - Export As

Selecting **Export As...** opens the **Export As...** dialog box, e.g.:

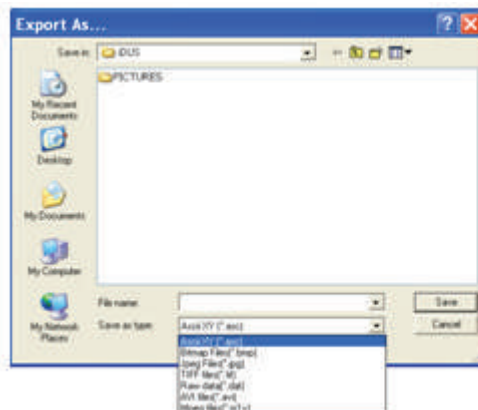

Depending on the Display & Readout modes selected, the file can be saved in one or more of the following formats:

- **ASCII (.asc)**
- **AVI (.avi)**
- **Bitmap (.bmp)**
- **GRAMS (.spc)**
- **Jpeg (.jpg)**
- **Mpeg (.m1v)**
- **Raw data (.dat)**
- **TIFF (.tif)**

Table 8 below shows a matrix of the actual combinations available.

Table 8: File Export combinations

READOUT MODE	DISPLAY MODE	EXPORT OPTIONS							
		ASCII	AVI	BMP	GRAMS	JPEG	MPEG	Raw Data	TIFF
Image	2D	<input checked="" type="checkbox"/>						<input checked="" type="checkbox"/>	
	3D	<input checked="" type="checkbox"/>						<input checked="" type="checkbox"/>	
Multi-Track	IMAGE	<input checked="" type="checkbox"/>	<input checked="" type="checkbox"/>	<input checked="" type="checkbox"/>	<input checked="" type="checkbox"/>	<input checked="" type="checkbox"/>	<input checked="" type="checkbox"/>	<input checked="" type="checkbox"/>	<input checked="" type="checkbox"/>
	2D	<input checked="" type="checkbox"/>						<input checked="" type="checkbox"/>	
	3D	<input checked="" type="checkbox"/>						<input checked="" type="checkbox"/>	
FVB	IMAGE	<input checked="" type="checkbox"/>	<input checked="" type="checkbox"/>	<input checked="" type="checkbox"/>	<input checked="" type="checkbox"/>	<input checked="" type="checkbox"/>	<input checked="" type="checkbox"/>	<input checked="" type="checkbox"/>	<input checked="" type="checkbox"/>
	2D	<input checked="" type="checkbox"/>	<input checked="" type="checkbox"/>	<input checked="" type="checkbox"/>	<input checked="" type="checkbox"/>		<input checked="" type="checkbox"/>	<input checked="" type="checkbox"/>	
	3D	<input checked="" type="checkbox"/>	<input checked="" type="checkbox"/>	<input checked="" type="checkbox"/>	<input checked="" type="checkbox"/>		<input checked="" type="checkbox"/>	<input checked="" type="checkbox"/>	
	IMAGE	<input checked="" type="checkbox"/>		<input checked="" type="checkbox"/>	<input checked="" type="checkbox"/>	<input checked="" type="checkbox"/>		<input checked="" type="checkbox"/>	<input checked="" type="checkbox"/>

7.1.5.1 - ASCII

File extension = .asc

ASCII (American **S**tandard **C**ode for **I**nformation **I**nterchange) is the most common format for text files in computers and on the Internet. In an ASCII file, each alphabetic, numeric, or special character is represented with a 7-bit binary number. 128 possible characters are defined.

Exporting Data as ASCII text means you can subsequently import your data into other applications (such as spreadsheets) that use the ASCII format.

After you have selected **ASCII XY (*.asc)** from the Save as type drop-down menu, allocated a filename and clicked **Save**, the **Save data** as dialog box appears, e.g.:

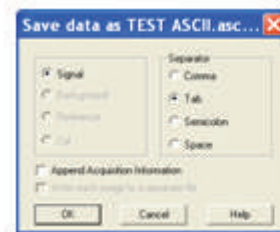

The radio buttons on the left allow you to choose whether you want to save the Signal, Background, Reference or Cal (calibration) data from the live data set.

The radio buttons on the right allow you to choose a character that will serve as a Separator between the numeric values in your raw data. You can then configure the importing application to recognize this separator (or delimiter) and in the case of a spreadsheet, display the data in a suitable configuration of rows and columns.

In an application such as Microsoft Excel you can perform this configuration by means of a wizard, launched automatically as you import the ASCII file.

Exporting data as ASCII text causes all the data associated with the data set to be exported, not just the portion of the data that is currently being displayed. Data which have been acquired through Single track or Full Vertical Binning will typically be displayed on a spreadsheet as a single column.

Data from acquisitions involving Multi-Track, Imaging or Kinetic Series are normally displayed in rows and columns. The columns represent the height (and/or the member of the kinetic series) and the rows the width of the CCD-chip.

7.1.5.2 - AVI

File extension = .avi

An **AVI** (Audio Video Interleaved) file is a sound and motion picture file that requires a special player.

After you have selected AVI files (.avi) from the Save as type drop-down menu, allocated a filename and clicked Save, the AVI Export dialog box appears, e.g.:

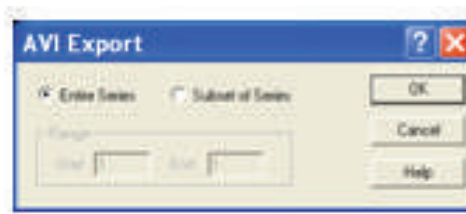

You can then select which series of data to export to the file.

7.1.5.3 - Bitmap

File extension = .bmp

BMP exports data in Microsoft Windows bitmap format that can be embedded into documents created in word processing and presentation packages, etc. If you adjust the image, it is the adjusted image that will be exported. After you have selected Bitmap Files (*.bmp) from the Save as type drop-down menu, allocated a filename and clicked Save, the file is saved.

7.1.5.4 - GRAMS

File extension = .spc

GRAMS (Graphic Relational Array Management System) is a software package that supports advanced data visualization and management. It is produced by Galactic Industries Corporation of Salem, New Hampshire.

After you have selected **GRAMS Files (*.spc)** from the Save as type drop-down menu, allocated a filename and clicked Save, the Export # dialog box appears, e.g. :

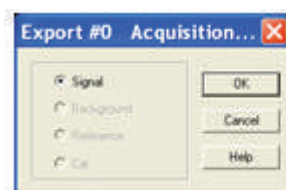

Provided data has been acquired in each format, you can select Signal, Background, Reference or Calibration data from the active data set.

7.1.5.5 - JPEG

File extension = .jpg

JPEG (Joint Photographic Experts Group) is a group of experts that develops and maintains standards for a suite of compression algorithms for computer image files. JPEG is a term used for any graphic image file produced by using a JPEG standard.

When you create a JPEG or convert an image from another format to a JPEG, you are asked to specify the quality of image you want. Since the highest quality results in the largest file, you can make a trade-off between image quality and file size.

After you have selected **Jpeg** Files (*.jpg) from the Save as type drop-down menu, allocated a filename and clicked Save, the file is saved.

7.1.5.6 - MPEG

File extension = .m1V

MPEG (Moving Picture Experts Group) is a standard for digital video and digital audio compression. MPEG standards are an evolving series, each designed for a different purpose.

After you have selected **Mpeg** (*.m1V) from the Save as type drop-down menu, allocated a filename and clicked Save, the file is saved.

7.1.5.7 - Raw Data

File extension = .dat

The .dat file comprises data only and has no header information of any kind. The original data set remains unchanged.

After you have selected Raw data (*.dat) from the Save as type drop-down menu, allocated a filename and clicked Save, the Export # dialog box appears, e.g.

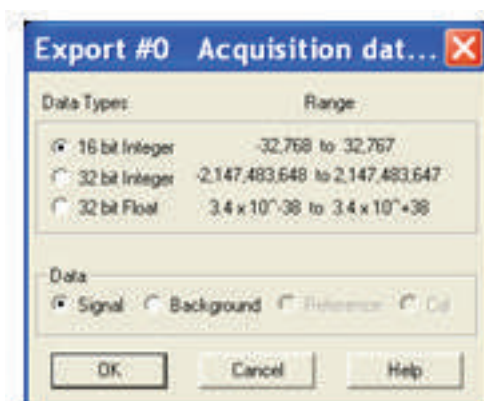

This allows the user to save a data set (currently in memory) to a file located on disk. A data set refers to a collection of data comprising one or more of the following subsets:

- **Signal**
- **Background**
- **Reference**
- **Cal**

A .dat file, however, will contain only one of the above data subsets.

Note: The Cal subset is used in radiometry/colorimetry measurements. It does not refer to the x-axis calibration of sig, bg or ref data.

The .dat file format reflects the CCD sensor format, e.g., with a CCD sensor of 1024 columns * 256 rows then the first 1024 data values in the .dat file correspond to the first row of the CCD, the second 1024 data values correspond to the second row, etc.

The .dat types range is shown in **Table 9**

Table 9: Types of .dat files

	DATA TYPE	NO. OF BYTES	RANGE
(1)	16 bit integer	2	-32,768 to 32,767
(2)	32 bit integer	4	-2,147,483,648 to 2,147,483,647
(3)	32 bit float	4	3.4×10^{-38} to $3.4 \times 10^{+38}$

(1) Saves a data set to a 16 bit integer .dat file.

NOTE: If a data value exceeds the limits of a 16-bit integer (<-32,768 OR > 32,767), that data value is truncated to the corresponding limit (e.g. if a data value is 36,000 units then the value is truncated to 32,767 units).

(2) Saves a data set to a 32 bit integer .dat file. The limits for the 32 bit integer are handled in similar fashion to the 16 bit integer above.

(3) Saves a data set to a 32 bit floating point .dat file.

When using your own software to handle a .dat file, you have to work out how many bytes to read in. Each 32 bit value requires 4 bytes to handle the value. Thus, for example, to read in a 32 bit .dat file consisting of 1024 data values, you would have to read in 4096 bytes in total.

7.1.5.8 - TIFF

File extension = .tif

TIFF (Tagged or Tag Image File Format) is used for storing bitmapped images and is widely supported by commercial publishing packages.

After you have selected from the Save as type drop-down menu and allocated a filename, the TIFF export dialog box appears, e.g.:

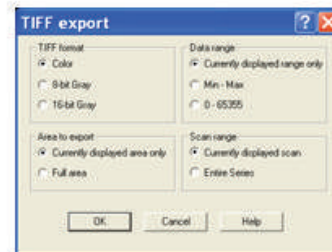

You can then choose the parameters you require to be displayed.

7.1.5.9 - Configuration Files

File extension = .cfg

A configuration file contains the values that appear on the system's dialog boxes whenever the application is launched, or whenever a configuration file is newly loaded.

Using configuration files is an easy way to tailor the overall application set-up to suit particular experiments. Configuration files reside in the same directory as the executable (.exe) of the application itself.

The factory-supplied configuration file (.cfg) contains typical default settings. Each time you start up the system, the .cfg is loaded automatically.

The files are accessed from the Configuration Files menu on the File drop-down menu of the Main Window as shown:

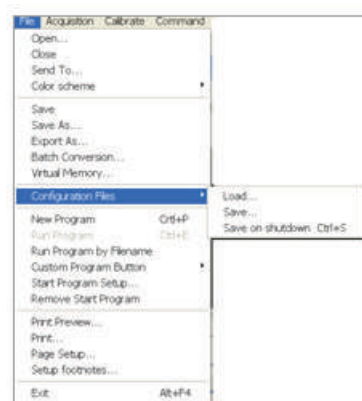

- **Load...** selects the configuration file you currently want to use. The system will immediately use the settings in the newly loaded file.
- **Save...** stores your current settings under a filename and in a directory of your own choosing. You can (if you wish) overwrite an existing configuration file.
- **Save on shutdown** stores your current settings under a filename when the computer is shutdown.

7.2 - PROGRAM SELECTION

The menus for working with Programs are selected from the File drop-down menu of the Main Window, e.g.:



Working with Programs is explained in more detail in **Section 9**.

SECTION 8 - CALIBRATION

8.1 - CALIBRATION OPTIONS

The following calibration options for data displays are available from the Calibration Menu on the Main Window:

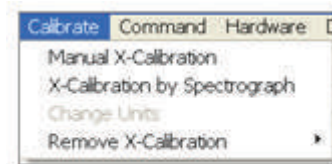

- **Manual X-Calibration:** lets you calibrate the x-axis of data displays by manually setting values (time, pixel number, wavelength, Raman shift or spatial position) against recognizable features of a particular 2D data trace.
- **X-Calibration by Spectrograph:** lets you calibrate the x-axis of your data displays with reference to your spectrograph's specifications. Calibration may be in wavelength or Raman shift.
- **Change Units:** lets you change the units on the x-axis of a data display (e.g. nm to μm , cm to pixel number, etc.)

In addition, the option **Remove X-Calibration** has 2 further options:

- Current Data returns the data in the active Data Window to its default pixel x-calibration.
- New Acquisitions causes future data to be acquired with the default pixel x-calibration.

8.2 - MANUAL X-CALIBRATION

Using newly acquired or previously stored data, select Manual X-Calibration from the Calibrate menu. The Manual X-Calibration dialog box appears, e.g.:

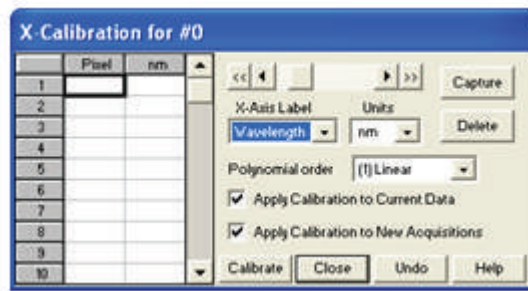

The number (#n) of the data window (or #0 in the case of an Acquisition Window) appears on the title bar of the dialog box.

8.2.1 - Supplying Calibration Details

To manually calibrate a data window, first use the drop-down lists on the Manual X-Calibration dialog box to choose the label and the units you wish to use for the x-axis. The available labels and units are shown here:

X-AXIS LABEL	UNITS
Wavelength	nm, μm , cm-1, eV
Raman Shift	cm-1
Position	μm , mm, cm, $\mu\text{i(nches)}$, in(ches)
Time	ms, secs
Pixel	pixels

Your chosen unit will appear on the top of the right-hand column of the two columns to the left of the Manual X-Calibration dialog box. Another drop-down list allows you to choose a polynomial order for your calibration. The following polynomial options are available:

POLYNOMIAL ORDER	DESCRIPTION
Linear	The linear fit is best for situations where only 2 or 3 spectral features can be identified.
Quadratic	A quadratic polynomial produces the best calibration fit if the known spectral features are located near the centre of the CCD sensor.
Cubic	A cubic polynomial produces the best calibration fit if the known spectral features are evenly distributed across the CCD sensor.

To perform the calibration:

1. Place the cross-hairs on a feature which you know to have a particular x-axis value and click Capture. If you wish to remove a point that you had previously selected, click Delete.
2. The pixel number will appear in the left-hand column. Against it, in the right-hand column, enter a value.

Repeat steps **1 & 2** for at least one other point. However, to achieve a good quality calibration you should choose a polynomial order fit commensurate with the spread of known spectral features across your sensor.

8.2.2 - Applying Calibration

Two check boxes on the Manual X-Calibration dialog box allow you to choose how the system should act upon the calibration details you have provided. You may select either or both of the following options:

1. **Apply Calibration to Current Data:** lets you change the x-axis calibration on an active data window whose filename (or #0 in the case of an Acquisition Window) appears on the title bar of the Manual X-Calibration dialog box.
2. **Apply Calibration to New Acquisitions:** the calibration details you have supplied in the Manual X-Calibration dialog box will be applied to any subsequent data acquisitions.

8.2.3 - Calibrate

Depending on the selections made using the check boxes on the Manual X-Calibration dialog box, clicking the Calibrate button will apply calibration to the active data window and/or to future data acquisitions

8.2.4 - When Manual X-Calibration goes wrong

In the event that Manual X-Calibration fails, it typically does so for one of two reasons:

- Data that you are attempting to calibrate are non-monotonic (for example, a wavelength that should correspond to a single pixel value has several pixel values)
- You have identified too few points (i.e. 0 or 1) for the system to perform a calibration. The system displays one or other of the following error dialog boxes:



8.2.4.1 - Data are Non-Monotonic

Your data may be **Non-Monotonic** if you have entered an incorrect value for one or more points on your data trace. An instance of grossly inaccurate manual calibration is shown here:



From Pixel 706 to Pixel 953 the user has indicated a fall in wavelength, despite the preceding rise in pixel 690. In such a case, an illegal non-monotonic calibration (as shown on the graph below) results.

The squares indicate points entered by a user, pixel values A, B and C illustrate the non-monotonicity of a sample wavelength of around 570 nm (i.e. three different pixel values for a single wavelength).

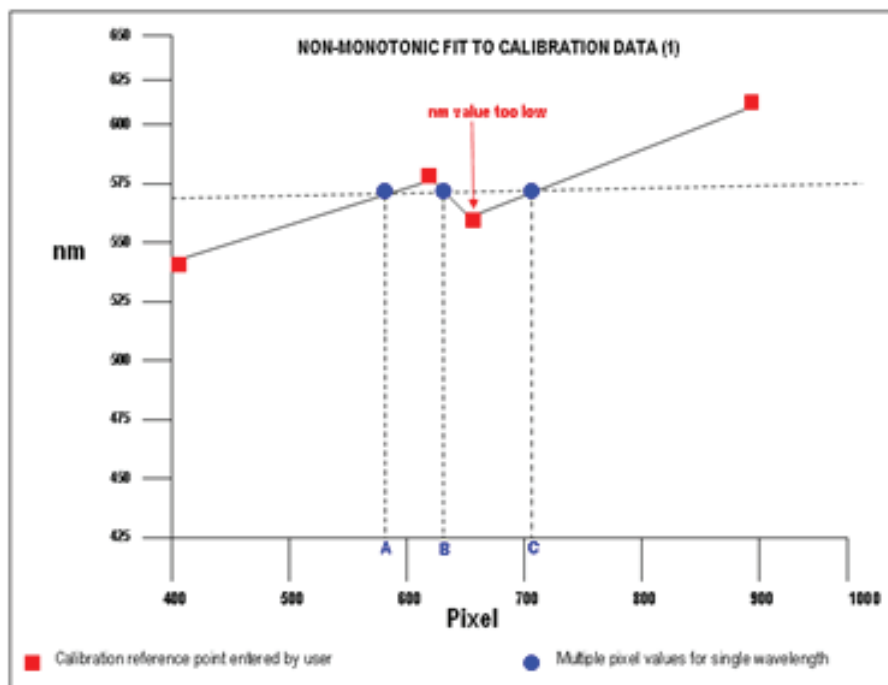

However, a non-monotonic calibration may come about even in cases where your data are not as grossly inaccurate as those shown in the example above. A non-monotonic calibration sometimes results if you attempt to calibrate points that are very close together on your trace, even if, for example, you are entering rising wavelength values against rising pixel values. In its background processing, the system models the calibration data (the user-supplied reference points) as a cubic polynomial. Inaccurate values mapped to pixels that are close together may cause the system to model the calibration data as shown in the graph below. Again certain (wavelength) values are non-monotonic relative to pixel value (see pixel values A and B, for example). The squares on the graph indicate points entered by the user, the rightmost point being at slightly too low a wavelength value.

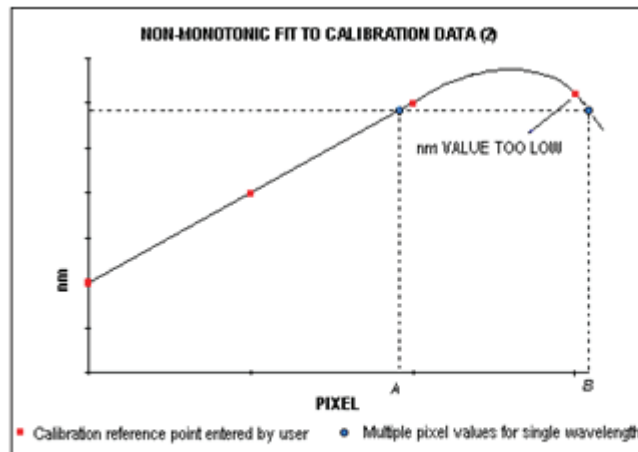

8.2.4.2 - Too few points

A calibration error will also occur if you have entered no data points, or only one data point, in the Manual X-Calibration dialog box. As general rule to obtain a good quality calibration, use more than five reference points, at regular intervals, across the full width of the CCD sensor.

8.2.5 - Undo

Click the Undo button to exit the Manual X-Calibration dialog box and to undo any calibrations that you have performed since entering the dialog box.

8.2.6 - Close

Click the Close button to exit the Manual X-Calibration dialog box.

8.3 - X-CALIBRATION BY SPECTROGRAPH

To calibrate data using the spectrograph, select the X-Calibration by Spectrograph option from the Calibration Menu. The Spectrograph X-Calibration dialog box will appear e.g.:

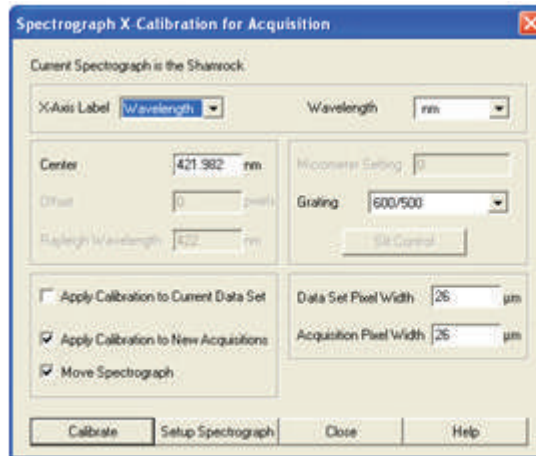

NOTE: This dialog box can also be opened by selecting the Setup Spectrograph option from the Hardware menu on the main window.

8.3.1 - Setup Spectrograph

Before you can perform a calibration using the spectrograph, you must ensure that the system knows which spectrograph you are using. To select the type of spectrograph to be used, click the **Setup Spectrograph** button on the **Spectrograph X-Calibration** dialog box and the **Setup Spectrograph** dialog box appears, e.g.:

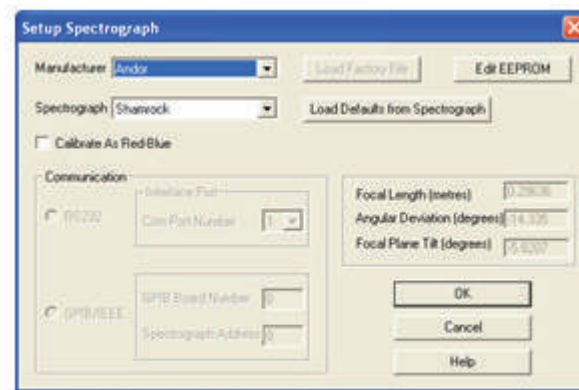

From the Manufacturer drop-down list, select the appropriate company name and from the Spectrograph drop-down list, select the model type being used, then click OK. The Spectrograph X-Calibration will appear again, with the details of the selected spectrograph.

With the exception of User Defined, selecting one of these options will cause the system to select and display (in grayed - i.e. non-writable - text boxes) your spectrograph's Focal Length, Angular Deviation and Focal Plane Tilt.

If you select the User Defined option from the drop-down list, you should consult the manufacturer's handbook for details, then key in the values for the spectrograph.

If you are using a motorized spectrograph, the system may be able to load spectrograph attributes (number of gratings, lines/mm, etc.) directly. The Load Defaults from Spectrograph button is enabled if an appropriate motorized spectrograph is chosen from the Spectrograph drop-down list.

Depending on the type of spectrograph being used, you can also select the type of interface needed from the Communication section of the dialog box.

8.3.1.1 - Calibrate As Red-Blue

Some CCD detectors readout data in the reverse direction to Andor cameras. In this case, the longer wavelengths (red) are to the left (as viewed from the detector), and shorter wavelengths (blue) are to the right.

If you tick the **Calibrate As Red-Blue** option in the Setup Spectrograph dialog box, the system then uses software to "reverse" the output of the detector when it generates a data window, thus presenting the display in the more usual orientation.

8.3.2 - Communications

The radio buttons in the **Communication** section of the **Spectrograph Setup** dialog box can be used to establish an interface between your computer and the spectrograph.

If you are using an Andor Shamrock SR303i, you can also choose between USB or I2C control links. Select Shamrock Control from the Hardware drop-down menu and the Shamrock Control dialog box appears e.g.:



Select USB for USB control or for I2C control select CCD, then click OK.

NOTE: When a Shamrock SR-303i is connected, the Shamrock icon;  appears in the menu bar of the main window.

In the event of an error in communication occurring, you will be prompted by a message, similar to the following:



8.3.2.1 - Other Spectrographs

If you have selected the Oriel MS257 spectrograph for example, you can now **Load Factory File**. This file supplies the system with important configuration details of your particular spectrograph. It must be loaded for the system to control the spectrograph correctly. The Factory File will have been supplied on diskette with your MS257 spectrograph.

Performing Load Factory File lets you save the file contents to the .ini file included with the Andor Solis software, after which the Factory File need not be loaded again.

When you click the Load Factory File button you will see a typical Windows 'Open File' dialog box. Select the directory and the filename of the file you wish to load, and click OK. The Factory File is now loaded.

8.3.2.2 - Reverse Spectrum

Some spectrographs produce somewhat “atypical” spectra, where longer wavelengths (red) are to the left (as viewed from the detector), and shorter wavelengths (blue) are to the right. If you select the MS127 or the FICS spectrograph from the drop-down list for example, you will notice a tick in a **Reverse Spectrum** check box. Because both these spectrographs are of this type, the Reverse Spectrum check box is ticked by default when these spectrographs are selected. The system then uses software to ‘reverse’ the output of the detector when it generates a data window, presenting the display in the more usual orientation.

You may, if you wish, disable the Reverse Spectrum function by clicking the check box.

8.3.2.3 - X-Axis Labels & Units

The Spectrograph X-Calibration Dialog box allows you to select, from scrollable drop-down list boxes, an X-Axis Label for your data window and an appropriate Unit of measurement. The following label & unit combinations are available:

X-Axis Label	Units
Wavelength	nm, μm, cm-1, eV
Raman Shift	cm-1

8.3.2.4 - Change Units

To change the x-axis units of an active data window which you have previously calibrated, select the Change Units option on the Calibrate Menu. The Change X-Calibration of Acquisition dialog box will appear on your screen, e.g.:

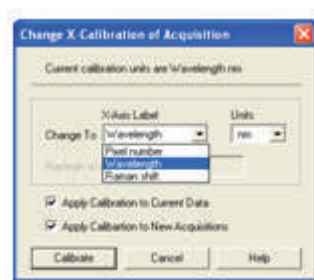

From the X-Axis Label drop-down list choose whether you want the x-axis to represent Wavelength, Pixel Number or Raman Shift. From the Units drop-down list, choose the units that you want to use for your recalibration. The available combinations depend on how the data were previously calibrated. If for instance, the data were previously calibrated in Wavelength and Nanometers the available combinations for recalibration are:

Wavelength	nm, μm , cm^{-1} , eV
Raman Shift	cm^{-1}
Pixel Number	-

Table 10 shows the available combinations for all modes.

Table 10: Label & Unit changes

	X-Axis Label	Units	Can Change to:
0	User Type	-	
1	Pixel Number (see Note 1. below)	-	
2	Wavelength	nm, μm , cm^{-1} , eV	1, 2, 3
3	Raman Shift	cm^{-1}	1, 2
4	Position	μm , mm, cm, $\mu\text{i(nches)}$, in(ches)	1, 4
5	Time	ms, s	1, 5
6	Sample	-	1

NOTES:

1. Changing from pixel number actually constitutes a new calibration and can only be performed by using Manual X-Calibration or X-Calibration by Spectrograph.
2. If you choose to recalibrate a data window in pixels, you will not be able to perform any further recalibrations on that window using the Change X-Calibration of Acquisition dialog box. If you save (under its previous filename) data that has been recalibrated in pixels, you will lose any previously saved calibration.

8.3.3 - Center Wavelength / Center of Raman Shift

The system allows you to adjust your spectrograph so that light of a chosen Wavelength or a chosen Raman Shift falls on the center of the CCD-chip.

These are referred to as the Center Wavelength and the Center of Raman Shift respectively.

If you have chosen Wavelength as your X-Axis Label, enter the Center Wavelength in the text box provided on the Spectrograph X-Calibration dialog box. If you have chosen Raman Shift as your X-Axis Label enter the Center of Raman Shift in the text box.

In each instance, the value is expressed in the units you selected previously above.

If you enter too large or too small a value an Error dialog box appears, e.g.:

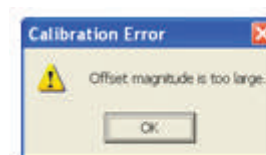
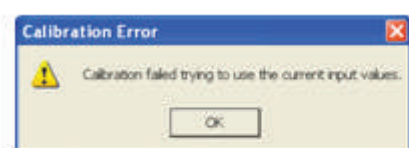

8.3.3.1 - Note on Raman Shift

The Raman Shift is calculated as follows:

If scatter is the wavelength of the Raman scattered light in nanometers and laser is the wavelength of the incident laser light in nanometers, then the Raman Shift in cm⁻¹ (i.e. rs) is calculated as follows:

$$rs = 107 \times [(scatter - laser) / (scatter \times laser)]$$

Thus, if **scatter < laser**, a negative Raman Shift (**anti-Stokes transition**) will result.

If **scatter > laser**, a positive Raman Shift (**Stokes transition**) will result.

Positive and negative values for Raman Shift may thus appear on the x-axis of a data window that is calibrated for Raman Shift, and may be used in the calibration process itself.

8.3.4 - Offset

By entering a value in the Offset text box of the Spectrograph X-Calibration dialog box you can compensate for small misalignments of the detector or the wavelength drive in your spectrograph. A positive value will cause the x-axis of the data window to move to the right (relative to the trace) by the corresponding number of pixels. A negative value will cause the x-axis to move to the left.

NOTE: To assess the accuracy of any calibration you have performed, you will need a calibration spectral line source, such as a helium neon laser or a mercury vapor lamp. Ideally, set the spectrograph to one of the prominent spectral lines, take a scan and use the cursor on the data window to determine any offset (in pixels) of the line from its true wavelength.

8.3.5 - Rayleigh Wavelength

If you have selected **Raman Shift** as your **X-Axis Label**, you must enter a value in nanometers for the Rayleigh Wavelength. In Raman Spectroscopy the Rayleigh Wavelength is that element of a spectrum line (in scattered radiation) whose wavelength is equal to that of the incident radiation (i.e. the laser wavelength) and is a product of ordinary or Rayleigh scattering.

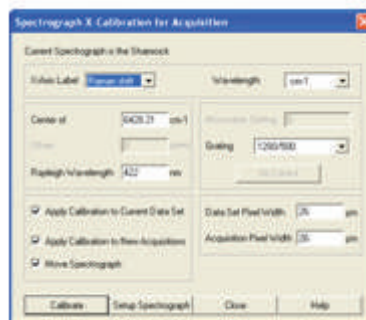

An Error Message will appear if you attempt to perform a calibration without having entered a valid Rayleigh Wavelength, e.g.:

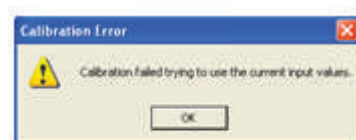

8.3.6 - Micrometer Setting

For certain non-motorized spectrographs, the system will calculate a Micrometer Setting that corresponds to the Grating and the Center Wavelength / Center of Raman Shift you have chosen. The Micrometer Setting allows you to manually adjust the angle of the diffraction grating (by means of the micrometer on the spectrograph housing), so that light of the wavelength / Raman shift of your choice falls on the centre of the CCD-chip.

The Micrometer Setting appears in a text box on the Spectrograph X-Calibration dialog box. You should use this value to manually set the micrometer on the spectrograph.

NOTES:

1. If you choose to enter a micrometer setting, the system will calculate a value for the Center Wavelength / Center of Raman Shift and vice versa. You need enter only one of the two values. Because Raman shift does not correlate linearly with wavelength (or pixel positions), the center column of pixels on the CCD-chip (e.g. column 512 on a chip of 1024 pixels) is likely to be represented off-center on the x-axis of a data window linearly calibrated for Raman shift. Column and where appropriate, row number, are expressed in the form [x,y] on the status bar along the bottom edge of the data window.
2. If you choose Raman Shift as the X-Axis label, the Center Wavelength text box is relabeled Center of Raman Shift.
3. In the case of motorized spectrographs, the wavelength drive is under direct software control.

8.3.7 - Grating

From the scrollable drop-down list select the specification of the diffraction grating you are currently using. Grating specifications are shown as a line density followed by (where applicable) a blaze wavelength.

8.3.8 - Close

To exit the Spectrograph X-Calibration dialog box, click Close.

NOTE: The details you supply regarding your spectrograph, including any retrieved data, will subsequently appear by default whenever you open the Spectrograph X-Calibration dialog box. You can change them whenever you choose.

8.3.9 - Processing Data via the Command Line

8.3.9.1 - Command Line

The Command Line allows you to enter one-line commands that are written in the Andor Basic programming language. These commands are used to manipulate acquired data. Several command lines can be entered and they are separated by “.”.

To open the Command Line dialog box, either click the  button or select the Command Line option from the Command drop-down menu. The dialog box opens as per the following example:



To run a command, click Execute. For further details on how to use the Andor Basic programming language, please refer to the User’s Guide to Andor Basic.

8.3.9.2 - Calculations

The **Calculations** option lets you display the output of colorimetry calculations in a CIE Calculations Window.

8.3.9.3 - Configure Calculations

The **Configure Calculations** option lets you choose which colorimetry calculations you are going to perform and which parameters you are going to use.

For further information, please refer to Colorimetry Calculations in the **Radiometry Guide**.

SECTION 9 - WORKING WITH PROGRAMS

9.1 - WORKING WITH ANDOR BASIC PROGRAMS

9.1.1 - Command Line

The Command Line gives you ready access to all functions and arithmetic data processing of the Andor Basic programming language, without the need to write programs. However, to process the contents of a data set, the data set must first be in memory (RAM), and a corresponding Data Window will therefore be on screen.

To open the Command Line, click the  button.

As an example, the following entry on the command line adds together the data in the data sets #1 and #2, and stores the result in a third, possibly new, data set labeled #100. Thus **#100 = #1 + #2**:



9.1.2 - Program Editor Window

Opening a program file, or selecting New Program from the File Menu launches a Program Editor Window where you can enter unformatted text, e.g:

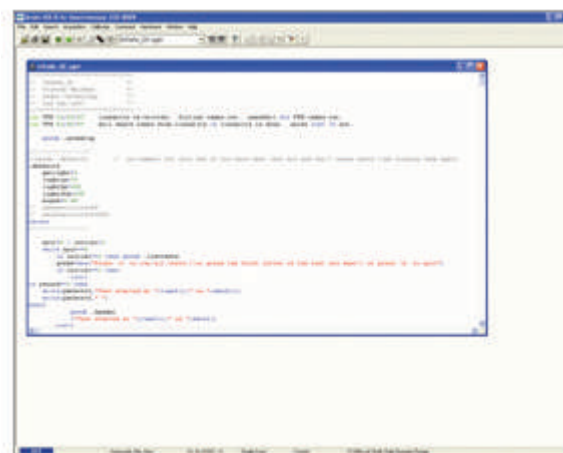





While you are working in the Program Editor Window, context sensitive help is available on the ‘reserved words’ of the programming language: with the cursor on or immediately after a reserved word, press Ctrl + F1.

9.1.3 - Accessing the Edit functions

Edit facilities are available either as edit buttons on the Main Window or as options on the Edit and Save Menus.

Some options (i.e. Cut and Copy) become available only when you have highlighted a segment of text; others are available only when preceded by another operation (Paste must be preceded by Cut or Copy). The following pages provide details of how to work with Andor Basic.

9.1.4 - Cut, Copy, Paste, Undo

- Cut  or Copy  text that you have highlighted. Paste the text into a new position.
- Paste  inserts cut or copied text into the position following the cursor, or replaces text that you have highlighted.
- Undo  causes the text to revert to its state before the last change was made

9.1.5 - Search

To search for items, either click on the  button on the Program Window or select **Find...** from the **Search** drop-down menu:



The Find dialog box appears:

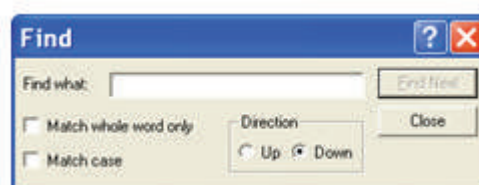

- In the **Find what** text box, type the word or phrase (the 'search string') that you want to find.
- **Select Match whole word** only to look for a complete word or for the same combination of capital and/or small letters as occur in the search string, select **Match case**.
- Select **Direction** to determine in which way the search will be carried out.

To activate the search, click on **Find Next** or click the  button.

9.1.6 - Replace

To replace items, select **Replace...** from the Search drop-down menu:

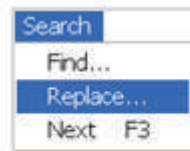

In the **Find what** text box, type in the search string and in the **Replace with** text box, type the word or phrase that you want to use instead, e.g.:

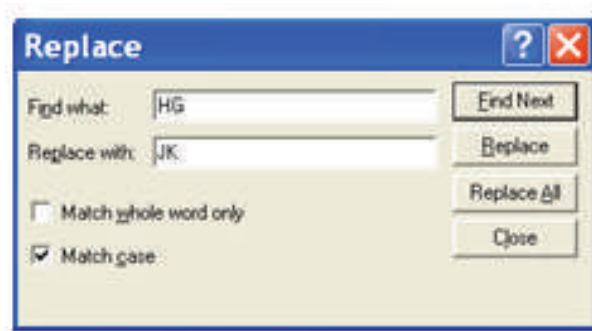

- Click the **Replace** button to change the next occurrence of the search string (or the highlighted search string if you have just used Find Next).
- Click **Replace All** to replace the search string wherever it occurs after the current cursor position.
- Check boxes let you match the whole word only and/or match the case of the letters.

9.1.7 - Run Program

To run a program, first ensure sure you have opened the appropriate **.pgm** file and ensure that the filename appears in the drop-down list box.

Secondly either click the  button or select **Run Program** from the File drop-down menu:

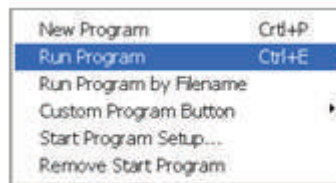

The program will now start. To change the name of the file you want to run, carry out one of the following actions:

- Open the drop-down list and click the name of the file
- Select an open Program Editor Window
- Open the **.pgm** file from the File menu

9.1.8 - Run Program by Filename

You can also run a program by means of the Run Program by Filename option on the File Menu.

Select **Run Program by Filename** from the File drop-down menu:

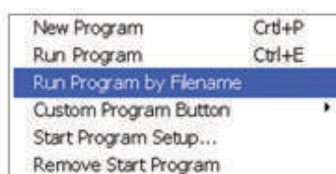

A standard Open dialog box appears, from which you may select the file whose contents you want to run. The file containing the program appears on screen as an iconized Program Editor Window and the program begins to execute immediately.

9.1.9 - Entering Program Input

Any text-based input required by the program (i.e. in Andor Basic you have indicated that the user must manually enter a value at a particular point in the program's execution) is entered via an Input dialog box.



SECTION 10 - TUTORIAL

10.1 - CALIBRATING DATA USING FLUORESCENT ROOM LIGHT

The object of this experiment is to let you learn to use the iDus by applying a wavelength calibration using a typical fluorescent room light as a source. You will need the following items:

- **iDus**
- **Fluorescent room light**
- **Spectrograph**

10.1.2 - Description

1. Attach the camera to the spectrograph. Ensure that the spectrograph has been fitted with a suitable diffraction grating (e.g. 600 l/mm) and that the spectrograph's micrometer (when using a manual spectrograph) has been set for a center wavelength of about 500 nm, i.e. in the middle of the visible range. For a 600 l/mm grating and center wavelength 500 nm the micrometer setting will be 250.
2. To remove dark signal, you should acquire data as background corrected counts. To select background corrected counts as your data type, open the **Acquisition** menu on the **Main Window** and select the option **Setup Data Type**. In the Data Type dialog box click the **Counts (Bg - corrected)** radio button and close the Data Type dialog box by clicking the OK button.
3. You are now ready to acquire data. Acquire the background data first. To ensure that the background is acquired in darkness, cover the input slit of the spectrograph (if you have no shutter) and from the **Acquisition** menu on the Main Window select the option Take Background. Background data is displayed on-screen under the **Bg tab** of an Acquisition window. Uncover the input slit of the spectrograph.
4. Now acquire the signal data. This data will automatically be background corrected. Point the spectrograph's input slit at a fluorescent room light. From the Acquisition menu on the Main Window select the option **Take Signal** (or alternatively, click the  button). By default the system will acquire signal data in Real Time mode, i.e. it will repeatedly acquire and display data until you press the **Esc** key or click the  button on the Main Window.
5. Signal data are displayed on-screen under the **Sig** tab of an Acquisition Window. If the signal appears weak (i.e. the signal data are at low numbers of counts on the data-axis) or if the CCD is saturating (there are 'plateaus' on the trace at the top of the data-axis) try repositioning the spectrograph relative to the light in order to change the light level. The system's default exposure time of 25ms should be adequate for acquiring data from typical room lighting. When you are happy with the signal strength, press the Esc key or click the  button on the Main Window to stop acquiring data.
6. Now calibrate these signal data. Use manual calibration so that you can identify and place wavelength values against features of the data trace. A typical data trace for a fluorescent room light is shown below (wavelength in nanometers is marked against the main features):

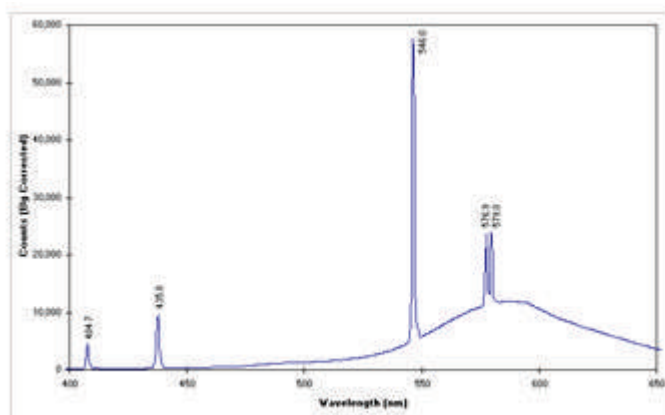

7. From the **Calibrate** menu select **Manual X-Calibration** and ensure the following :

- The **X-Axis Label Wavelength** entry in the **Units** list box is set to **nm**
- The Apply Calibration to Current Data checkbox is ticked.

NOTE: The data range and relative intensities will vary with operating conditions and specification of equipment used.

8. Click the trace in the Acquisition window at one of the points that you recognize as having a particular value (you may have to use the left and right arrow keys to 'fine tune' the cursor location to a peak). It is best to use peaks that are reasonably well separated when you perform a calibration. Attempting to calibrate both peaks of the yellow doublet is not recommended, for example. Click the **Capture** button on the **X-Calibration** dialog box. A pixel number (the x-axis co-ordinate of the point you selected on the trace) now appears in the two-column spreadsheet of the Manual X-Calibration dialog box. Beside the pixel number enter the wavelength that corresponds to the feature on the trace. Repeat this process for several other features on the trace then click the Calibrate button.
9. If you have identified one or more of the points on the trace incorrectly, so that the scale on the x-axis (if calibration were attempted) would not be monotonic, an error dialog box will warn you that the calibration of your trace has not been changed. Close the error dialog box by clicking the OK button.
10. In the **Manual X-Calibration** dialog box, re-examine the values you have entered. You may click the Delete button to remove any point you no longer wish to use for calibration, or you may overwrite a value that you previously entered with a new value. Click the Calibrate button again.

If you have selected and labeled the points on the trace accurately, the data in the Acquisition Window will now be calibrated in nm.

APPENDIX

A1.1 - GLOSSARY

If this is the first time you have used Andor's CCD, the glossary that follows will help you to familiarize yourself with its design philosophy and some of its key terminology.

A1.1.1 - CCD

A **Charge Coupled Device (CCD)** is a silicon-based semiconductor chip bearing a two-dimensional matrix of photo-sensors, or pixels. This matrix is usually referred to as the **'image area'**. The pixels are often described as being arranged in rows and columns (rows running horizontally, columns vertically). A typical CCD-chip may comprise 256 rows and 1024 columns, or 578 rows and 385 columns.

The CCD in your camera is a scientific slow scan device (in contrast to the fast scan CCD used in video cameras to capture moving images). An example of a typical layout is shown here:

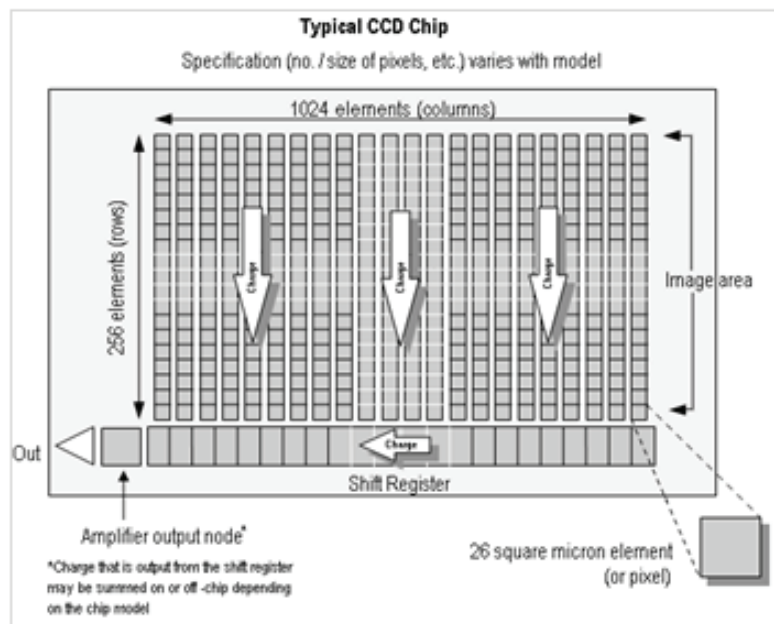

The **Shift Register** runs below and parallel to the light collecting rows. It has the same number of pixels as a light-collecting row, but is itself masked, so that no light can fall on it. When light falls on an element, electrons (photoelectrons) are produced and (in normal operation), these electrons are confined to their respective elements. Thus, if an image (or any light pattern) is projected on to the array, a corresponding charge pattern will be produced. To capture the image pattern into computer memory, the charge pattern must be transferred off the chip, and this is accomplished by making use of a series of horizontal (i.e. parallel to the rows/shift register) transparent electrodes that cover the array.

By suitable ‘clocking’, these electrodes can be used to shift (transfer) the entire charge pattern, one row at a time, down into the shift register. The shift register also has a series of electrodes (which are vertical, i.e. parallel to the columns) which are used to transfer the charge packets, one element at a time, into the output node of the ‘on-chip’ amplifier. The output of the amplifier feeds the **Analog-to-Digital (A/D)** converter, which in turn converts each charge packet into a 16-bit binary number.

A1.1.1.1 - Readout Sequence of a CCD

In the course of readout, charge is moved vertically into the shift register, and then horizontally from the shift register into the output node of the amplifier. The readout sequence illustrated below (which corresponds to the default setting of the **Full Resolution Image** binning pattern) allows data to be recorded for each individual element on the CCD-chip. Other binning patterns are achieved by summing charge in the shift register and/or the output node prior to readout (please see **Vertical Binning** and **Horizontal Binning** on **page 138**).

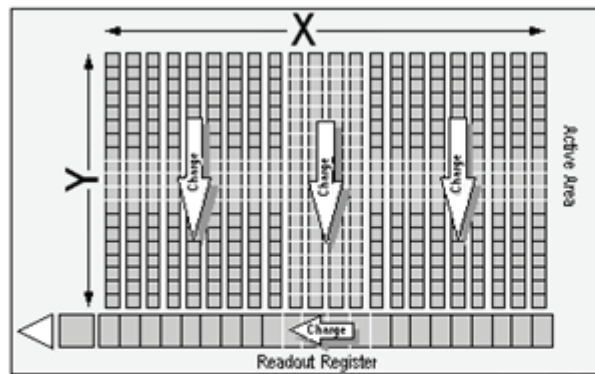

- 1 Exposure to light causes a pattern of charge (an electronic image) to build up on the frame (or ‘image area’) of the CCD-chip.
- 2 Charge in the frame is shifted vertically by one row, so that the bottom row of charge moves into the shift register.
- 3 Charge in the shift register is moved horizontally by one pixel, so that charge on the endmost pixel of the shift register is moved into the output node of the amplifier.
- 4 The charge in the output node of the amplifier is passed to the analog-to-digital converter and is read out.
- 5 **Steps 3 & 4** are repeated until the shift register is emptied of charge.
- 6 The frame is shifted vertically again, so that the next row of charge moves down into the shift register. The process is repeated from Step 3 until the whole frame is read out.

A1.1.2 - Accumulation

Accumulation is the process by which data that have been acquired from a number of similar scans are added together in computer memory. This results in improved signal to noise ratio.

A1.1.3 - Acquisition

An Acquisition is taken to be the complete data capture process.

A1.1.4 - A/D Conversion

Charge from the CCD is initially read as an analog signal, ranging from zero to the saturation value. A/D (Analog to Digital) conversion changes the analog signal to a binary number which can then be manipulated by the computer.

A1.1.5 - Background

Background is a data acquisition made in darkness. It is made up of fixed pattern noise, and any signal due to dark current.

A1.1.6 - Binning

Binning is a process that allows charge from two or more pixels to be combined on the CCD-chip prior to readout (please see **Readout Sequence of a CCD on page 137**). Summing charge on the CCD and doing a single readout results in better noise performance than reading out several pixels and then summing them in the computer memory. This is because each act of reading out contributes to noise. For further information on **Noise**, please see **page 142**.

The two main variants of the binning process are vertical binning and horizontal binning, which are individually described in the pages that follow. In addition there are several binning patterns that tailor the main binning variants to typical application usage.

A1.1.6.1 - Vertical Binning

In Vertical Binning, charge from two or more rows of the CCD-chip is moved down into the shift register before the charge is read out. The number of rows shifted depends on the binning pattern you have selected. Thus, for each column of the CCD-chip, charge from two or more vertical elements is 'summed' into the corresponding element of the shift register. The charge from each of the pixels in the shift register is then shifted horizontally to the output node of the amplifier and read out.

Variants of Vertical Binning are used to affect a variety of binning patterns and they are as follows:

- **Single-Track:** charge is vertically binned and read out from a number of complete, adjacent rows of pixels on the CCD-chip. The rows form a single track across the full width of the CCD-chip. A value is taken for each column in the track.
- **Multi-Track:** Multi-Track mode differs from Single-Track in that you may now define two or more tracks from which to read out charge. In processing terms, each track is treated as in Single-Track above.
- **Full Vertical Binning (FVB):** charge from each complete column of pixels on the CCD is moved down and summed into the shift register and the charge is then shifted horizontally one pixel at a time from the shift

register into the output node - in effect a value is read out for each complete column of the CCD-chip.

The example below illustrates readout of data from adjacent tracks, each track comprising two binned rows of the CCD-chip.

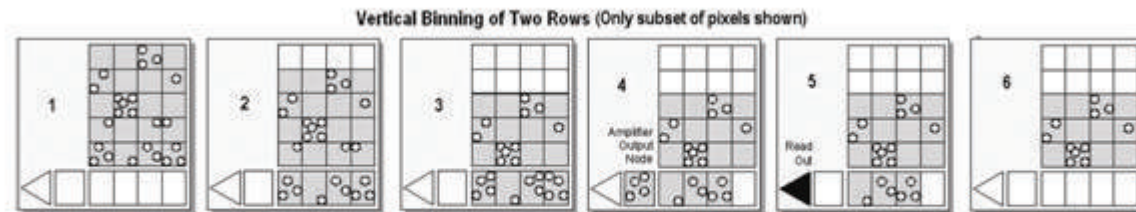

- 1 Exposure to light causes a pattern of charge (an electronic image) to build up on the frame (or **Image Area**) of the CCD-chip.
- 2 Charge in the frame is shifted vertically by one row, so that the bottom row of charge moves down into the shift register.
- 3 Charge in the frame is shifted vertically by a further row, so that the next row of charge moves down into the shift register, which now contains charge from two rows - i.e. the charge is vertically binned
- 4 Charge in the shift register is moved horizontally by one pixel, so that charge on the endmost pixel of the shift register is moved into the output node of the amplifier.
- 5 The charge in the output node of the amplifier is passed to the analog-to-digital converter and is read out.
- 6 Steps 4 & 5 are repeated until the shift register is empty. The process is repeated from Step 2 until the whole frame is read out.

A1.1.6.2 - Horizontal Binning (Creating Superpixels)

Shifting the charge horizontally from several pixels at a time into the output node is known as horizontal binning.

Horizontal binning, in combination with vertical binning, allows you to define so-called superpixels that in Image Display Mode represent as a single picture element charge that has been binned from a group of pixels. For example, charge that is binned vertically from two rows and horizontally from two pixels before being read out, is displayed as a superpixel of dimensions 2 x 2 pixels.

On the one hand, superpixels (by comparison with single pixels) result in a more coarsely defined image when the data are displayed in **Image** misplay mode. On the other hand, superpixels offer the advantages of summing data on-chip prior to readout. In the example below, where each superpixel is of dimensions 2 x 2 pixels, charge from two rows is first binned vertically into the shift register; then charge from two pixels of the shift register is binned horizontally into the output node of the amplifier. The effect of the combined binning processes is a summed charge equating to a 2 x 2 'superpixel'.

Since this example initially involves binning charge from two rows, the process begins in the same way as shown in

Steps 1 - 4 of Vertical Binning of Two Rows on page 138 then horizontal binning begins.

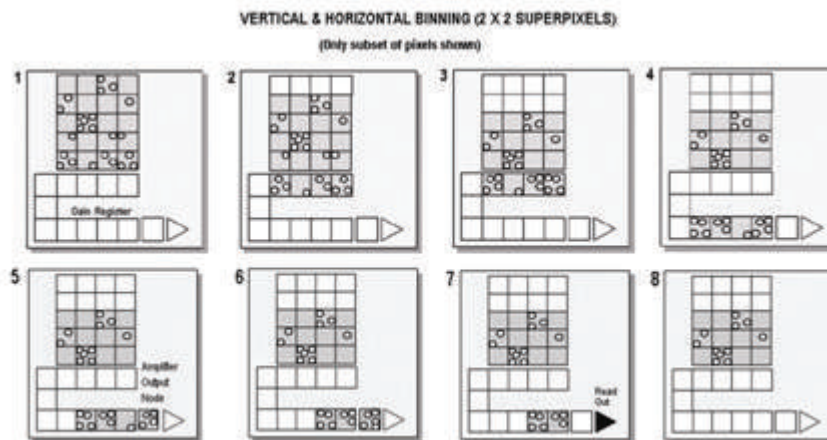

- 5 Charge from two rows has already been vertically binned into the shift register (see **Vertical Binning of Two Rows on page 139**). Now charge in the shift register is moved horizontally by one pixel, so that charge on the endmost pixel of the shift register is moved into the output node of the amplifier.)
- 6 Charge in the shift register is again moved horizontally, so that the output node of the amplifier now contains charge from two pixels of the shift register - i.e. the charge has been horizontally binned.
- 7 The charge in the output node of the amplifier is passed to the analog-to-digital converter and is read out.
- 8 **Steps 4 - 6** are repeated until the shift register is empty. The process is repeated from **Step 2** (again, please refer to **page 139**) until the whole frame is read out.

A1.1.7 - Counts

Counts refer to the digitization by the A/D conversion and are the basic unit in which data are displayed and processed. Depending on the particular version of the detection device, one count may, for example, be equated with a charge of 10 photoelectrons on a pixel of the CCD.

A1.1.8 - Dark Signal

Dark signal, a charge usually expressed as a number of electrons, is produced by the flow of dark current during the exposure time. All CCD's produce a dark current, an actual current that is measurable in (typically tenths of) milliamps per pixel. The dark signal adds to your measured signal level, and increases the amount of noise in the measured signal. Since the dark signal varies with temperature, it can cause background values to increase over time. It also sets a limit on the useful exposure time.

Reducing the temperature of the CCD reduces dark signal (typically, for every 7°C that temperature falls, dark signal halves). CCD readout noise is low, and so as not to compromise this by shot noise from the dark signal, it is important

to cool the detector to reduce the dark signal. If you are using an exposure time of less than a few seconds, cooling the detector below 0°C will generally remove most of the shot noise caused by dark signal.

A1.1.9 - Detection Limit

The Detection Limit is a measure of the smallest signal that can be detected in a single readout. The smallest signal is defined as the signal whose level is equal to the noise accompanying that signal, i.e. a signal to noise ratio (S/N) of unity.

Sources of noise are:

- **Shot noise of the signal itself**
- **Shot noise of any dark signal**
- **Readout noise**

If the signal is small, we can ignore its shot noise.

Furthermore, if a suitably low operating temperature and short exposure time can be achieved, the lowest detection limit will equal the readout noise.

A1.1.10 - Exposure Time

Exposure Time is the period during which the CCD collects light prior to readout.

A1.1.11 - Frame Transfer

Frame transfer is a mode of operation of the chip. It can be switched on for any acquisition mode. It is only available if your system contains a **Frame Transfer CCD (FT CCD)**.

An FT CCD differs from a standard CCD in 2 ways:

1. Firstly, an FT CCD contains 2 areas, of approximately equal size (see **figure 6** below).
 - The first area is the **Image** area, this area is at the top and farthest from the read-out register. It is in this area that the CCD is sensitive to light.
 - The second area is the **Storage** area and sits between the Image area and the read-out register. This area is covered by an opaque mask, usually a metal film, and hence is not sensitive to light.
2. The second way in which an FT CCD differs from a standard CCD is that the **Image** and the **Storage** areas can be shifted independently of each other.

These differences allow an FT CCD to be operated in a unique mode where one image can be read out while the next image is being acquired. It also allows an FT CCD to be used in imaging mode without a shutter.

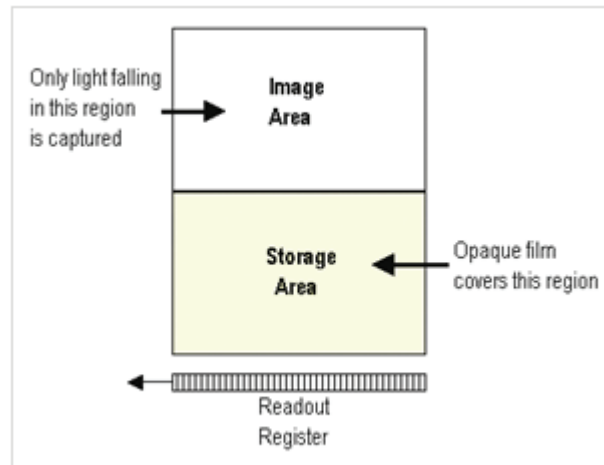

Figure 6: iDus camera

A1.1.12 - Noise

Noise is a complex topic, the full exploration of which is beyond the scope of this glossary. Noise may, however, be broken down into two broad categories as follows:

- **Pixel Noise**
- **Fixed Pattern Noise**

These two categories are described in the paragraphs that follow.

A1.1.12.1 - Pixel Noise

Let us first attempt to define pixel noise. Assume that a light signal is falling on a pixel of the CCD. If the charge on the pixel is read, and the read process is repeated many times, the noise may be taken as the variation in the values read. The Root Mean Square (r.m.s.) of these variations is often used to express a value for noise. As a rule of thumb, the r.m.s. is four to six times smaller than the peak to peak variations in the count values read from the pixel. Pixel noise has three main constituents:

- **Readout noise**
- **Shot noise from the dark signal**
- **Shot noise from the light signal itself**

Shot noise cannot be removed because it is due to basic physical laws. In the most simple terms, shot noise may be described as the square root of the signal (or dark signal) measured in electrons.

A1.1.12.1.1 - Readout Noise

Readout noise (which in our cameras is, in any case, low) is due to the amplifier and electronics: it is independent of dark signal and signal levels; it is only very slightly dependent on temperature; and it is present on every read, as a result of which it sets a limit on the best achievable noise performance.

Shot noise from the dark signal is dependent on the exposure time and is very dependent on the temperature; shot noise from the signal is additionally dependent on the signal level itself. If either the signal or the dark signal falls to zero, their respective shot noise also falls to zero.

The total pixel noise is not, however, simply the sum of the three main noise components (readout noise, shot noise from the dark signal, and shot noise from the signal).

Rather, the Root Sum Square (r.s.s.) gives a reasonable approximation - thus:

$$\text{total} = \text{sqrt}(\text{readnoise}^2 + \text{darkshot}^2 + \text{sigshot}^2)$$

where:

- **total** is the pixel noise
- **readnoise** is the readout noise
- **darkshot** is the shot noise of the dark signal
- **sigshot** is the shot noise of the signal

A1.1.12.1.2 - Shot Noise

Shot Noise is due to basic physical laws and cannot be removed. Any signal, whether it be a dark signal or a light signal, will have shot noise associated with it. This is most simply defined as:

If the signal or dark signal = **N** electrons, the shot noise is the square root of **N**.

You can do nothing about the shot noise of your signal, but by choosing minimum exposures and operating the CCD at suitably low temperatures, the dark signal, and hence the noise from the dark signal, can be reduced.

A1.1.12.1.3 - Fixed Pattern Noise

Fixed Pattern Noise (FPN) consists of the differences in count values read out from individual pixels, even if no light is falling on the CCD detector. These differences remain constant from read to read. The differences are due in part to a variation in the dark signal produced by each pixel, and in part to small irregularities that arise during the fabrication of the CCD.

Since fixed pattern noise is partly due to dark signal, it will change if the temperature changes, but because it is fixed, it can be completely removed from a measurement by background subtraction.

A1.1.13 - Pixel

A Pixel is an individual photosensor (or element) on a CCD.

A1.1.14 - Quantum Efficiency / Spectral Response

The glossary refers to signals as a number of electrons. More strictly speaking these are '**photoelectrons**', created when a photon is absorbed. When a UV or visible photon is absorbed by the CCD detector it can at best produce only one photoelectron. Photons of different wavelengths have different probabilities of producing a photoelectron and this probability is usually expressed as **Quantum Efficiency (QE)** or **Spectral Response**.

QE is a percentage measure of the probability of a single photon producing a photoelectron, while spectral response is the number of electrons that will be produced per unit photon energy. Many factors contribute to the QE of a CCD, but the most significant factor is the absorption coefficient of the silicon that serves as the bulk material of the device.

A1.1.15 - Readout

Readout is the process by which data are taken from the pixels of the CCD and stored in computer memory. The pixels, which are arranged in a single row, are read out individually in sequence. Readout involves amplifying the charge on each pixel into a voltage, performing an A/D conversion, and storing the data in computer memory. The time taken to perform this operation is known as the 'read time'.

A1.1.16 - Saturation

Saturation is the largest signal the CCD can measure. A signal is measured in terms of the amount of charge that has built up in the individual pixels on the CCD-chip. A number of factors determine the maximum amount of charge that the CCD can handle.

A1.1.17 - Scan Types: Keep Clean & Acquired

The CCD is continually being '**scanned**' to prevent its becoming saturated with dark current (see dark signal). If the Scan is being used simply to '**clean**' the CCD (i.e. it is a keep-clean scan), the charge from the CCD is discarded.

In an acquired scan, however, the charge undergoes A/D conversion and is acquired into computer memory so that it can be used for subsequent processing and display: it is '**read out**' (see **Readout** previously). In this User's Guide 'scan' generally refers to an acquired scan - unless the context specifically indicates otherwise.

A1.1.18 - Signal to Noise Ratio

The **Signal to Noise Ratio** (commonly abbreviated as **S/N** or **SNR**) is the ratio between a given signal and the noise associated with that signal. Noise has a fixed component, and a variable component (shot noise) which is the square root of the signal. Thus, the SNR usually increases (improves) as the signal increases.

The maximum SNR is the ratio between the maximum signal (i.e. the saturation level) and the noise associated with that signal. At near saturation levels the dominant source of noise is the shot noise of the signal.

A1.2 - MECHANICAL DIMENSIONS

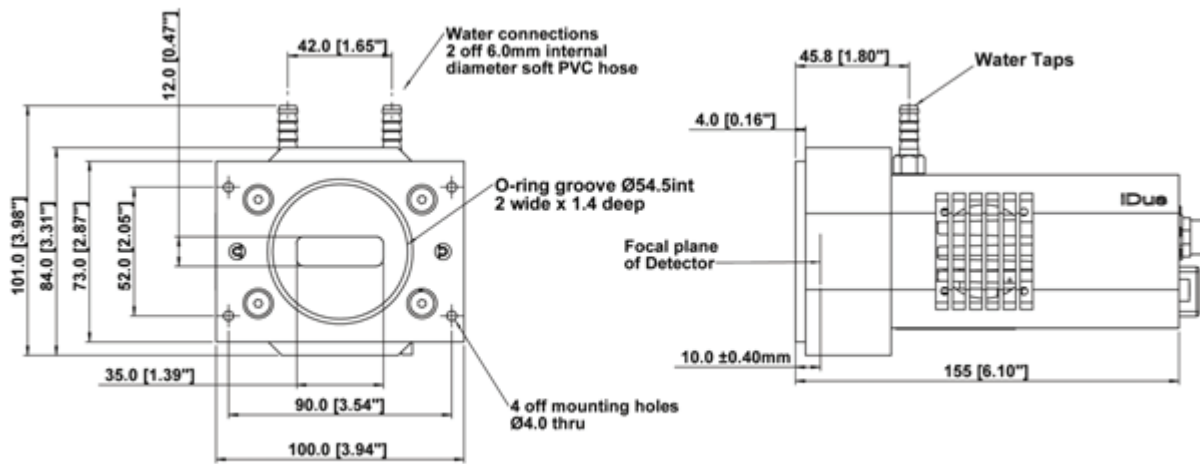

NOTES:

1. There are two mounting holes (1/4-20UNC), one located on the top of the CCD head and one on the bottom. They are positioned centrally at a distance of 22.3 mm from the front of the front face.
2. Cable clearances required at rear of camera:

Exit connector type	Clearance
PS24 & PS25 cable	90mm
USB cable	60mm
Right angled variant of power supply cable	40mm

A1.3 - TERMS & CONDITIONS

In these conditions:

1. 'Buyer' means the person who accepts a quotation of the seller for the sale of the goods or whose order for the goods is accepted by the seller.

'Goods' means the goods (including any instalment of the goods or any parts for them) which the seller is to supply in accordance with these conditions.

'Seller' means Andor Technology plc.

'conditions' means the standard terms and conditions of sale set out in this document and (unless the context otherwise requires) includes any special terms and conditions agreed in writing between the buyer and seller.

'Contract' means the contract for the purchase and sale of the goods.

'Writing' includes telex, cable, facsimile transmission and comparable means of communication.

2. Any reference in these conditions to any provision of a statute shall be construed as a reference to that provision as amended, re-enacted or extended at the relevant time.
3. The headings in these conditions are for convenience only and shall not affect their interpretation.

A1.4 - WARRANTIES & LIABILITY

1. Subject to these conditions set out below, the seller warrants that the goods will correspond with their specification at the time of delivery and will be free from defects in material and workmanship for a period of 12 months from the date of delivery.
2. The above warranty is given by the seller subject to the following conditions:
 - 2.1 The seller shall be under no liability in respect of any defect in the goods arising from any drawing, design or specifications supplied by the buyer;
 - 2.3 The seller shall be under no liability in respect of any defect arising from fair wear and tear, wilful damage, negligence, abnormal working conditions, failure to follow the seller's instructions (whether oral or in writing), misuse or alteration or repair of the goods without the seller's approval;
 - 2.3 The seller shall be under no liability under the above warranty (or other warranty, condition or guarantee) if the total price for the goods has not been paid by the due date for payment;
 - 2.4 The above warranty does not extend to parts, material or equipment not manufactured by the seller, in respect of which the buyer shall only be entitled to the benefit of any such warranty or guarantee as is given by the manufacturer to the seller.
3. Subject as expressly provided in these conditions, and except where the goods are sold to a person dealing as a consumer (within the meaning of the unfair contract terms act 1977), all warranties, conditions or other terms implied by statute or common law are excluded to the fullest extent permitted by law.
4. Any claim by the buyer which is based on any defect in the quality or condition of the goods or their failure to correspond with specification shall (whether or not delivery is refused by the buyer) be notified in writing to the seller within 7 days from the date of delivery or (where the defect or failure was not apparent on reasonable inspection) discovery of the defect or failure. If delivery is not refused, and the buyer does not notify the seller accordingly, the buyer shall not be entitled to reject the goods and the seller shall have no liability for such defect or failure, and the buyer shall be bound to pay the price as if the goods had been delivered in accordance with the contract. In no event shall the buyer be entitled to reject the goods on the basis of any defect or failure which is so slight that it would be unreasonable for him to reject them.
5. Where any valid claim in respect of the goods which is based on any defect in the quality or condition of the goods or their failure to meet specification is notified to the seller in accordance with these conditions, the seller shall be entitled to replace the goods (or the part in question) free of charge or, at the seller's sole discretion, refund to the buyer the price of the goods (or a proportionate part of the price), but the seller shall have no further liability to the buyer.
6. Except in respect of death or personal injury caused by the seller's negligence, the seller shall not be liable to the buyer by reason of any representation (unless fraudulent), or any implied warranty, condition or other term, or any duty at common law, or under the express terms of the contract, for any indirect, special or

consequential loss or damage (whether for loss of profit or otherwise), costs, expenses or other claims for compensation whatsoever (whether caused by the negligence of the seller, its employees or against otherwise) which arise out of or in connection with the supply of the goods, or their use or resale by the buyer and the entire liability of the seller under or in connection with the contract shall not exceed the price of the goods, except as expressly provided in these conditions.

7. The seller shall not be liable to the buyer or be deemed to be in breach of the contract by reason of any delay in performing, or any failure to perform, any of the seller's obligations in relation to the goods, if the delay or failure was due to any cause beyond the seller's reasonable control. without prejudice to the generality of the foregoing, the following shall be regarded as causes beyond the seller's reasonable control:
- 7.1 Act of God, explosion, flood, tempest, fire or accident;
 - 7.2 War or threat of war, sabotage, insurrection, civil disturbance or requisition;
 - 7.3 Acts, restrictions, regulations, bye-laws, prohibitions or measures of any kind on the part of any governmental, parliamentary or local authority;
 - 7.4 Import or export regulations or embargoes;
 - 7.5 Strikes, lock-outs or other industrial actions or trade disputes (whether involving employees of the seller or of third party);
 - 7.6 Difficulties in obtaining raw materials, labour, fuel, parts or machinery;
 - 7.7 Power failure or breakdown in machinery.

A1.5 - TERMS AND CONDITIONS OF SALE

TERMS AND CONDITIONS OF SALE

The terms and conditions of sale, including warranty conditions, will have been made available during the ordering process. The current version may be viewed at:

http://www.andor.com/contact_us/support_request/warranty/standard_warranty.pdf



WASTE ELECTRICAL AND ELECTRONIC EQUIPMENT (WEEE)

The company's statement on the disposal of WEEE can be found in the Terms and Conditions.