

# FemtoLux 3



FemtoLux 3 is a modern femtosecond fiber laser aimed for both R&D use and industrial integration. Tunable pulse duration in a range of 300 fs – 5 ps, adjustable pulse repetition rate up to 10 MHz and adjustable pulse energy up to 3  $\mu$ J allows optimization of laser parameters for the desired application. These include marking and volume structuring of transparent materials, photopolymerization, biological imaging, nonlinear microscopy and many others. To expand the scope of applications even further this laser can be equipped with a second harmonics module.

With burst mode enabled, FemtoLux 3 can generate bursts of pulses with energy above 10  $\mu$ J with instant burst shape control which can significantly improve the efficiency of some processes.

Having a rigid, compact, passive air-cooled laser head and the possibility to control the laser from a wireless tablet, FemtoLux 3 can be integrated with different equipment, be it laser equipment for material micro-processing, microscopy or any other research equipment.

## Microjoule Class Femtosecond Industrial Lasers

### FEATURES

- ▶ **300 fs ... 5 ps** tunable pulse duration
- ▶ **Output power 3 W at 1030 nm or 1.2 W at 515 nm**
- ▶ **Up to 3  $\mu$ J/pulse and 10  $\mu$ J/burst (at 1030 nm)**
- ▶ **Up to 1.2  $\mu$ J/pulse and 5  $\mu$ J/burst (at 515 nm)**
- ▶ **Excellent beam quality  $M^2 < 1.2$**
- ▶ **Versatile laser control and synchronisation capabilities**
- ▶ **Up to 10 MHz pulse repetition rate**
- ▶ **Smart triggering for synchronous operation with polygon scanner and PSO**
- ▶ **Instant amplitude control**
- ▶ **Passive air cooling of the laser head**
- ▶ **24/7 operation**

### APPLICATIONS

- ▶ **Inner volume marking of transparent materials**
- ▶ **Marking and structuring**
- ▶ **Micromachining of brittle materials**
- ▶ **Photopolymerization**
- ▶ **Ophthalmologic surgery**
- ▶ **Biological Imaging**
- ▶ **Pumping of femtosecond OPO/OPA**
- ▶ **Microscopy**

SPECIFICATIONS <sup>1)</sup>

Model	FemtoLux 3
<b>MAIN SPECIFICATIONS</b>	
Central wavelength	
Fundamental	1030 ± 2 nm
With second harmonic option	515 ± 1 nm
Minimal pulse duration (FWHM) at 1030 nm	< 300 fs (typical ~230 fs)
Pulse duration tuning range	300 fs – 5 ps
Maximal average output power <sup>2)</sup>	
at 1030 nm	> 3 W
at 515 nm	> 1.2 W
Power long term stability (Std. dev.) <sup>3)</sup>	≤ 0.5 %
Maximal pulse energy <sup>2)</sup>	
at 1030 nm	> 3 μJ
at 515 nm	> 1.2 μJ
Pulse energy stability (Std. dev.) <sup>4)</sup>	< 2 %
Laser pulse repetition rate (PRR <sub>L</sub> ) range <sup>5)</sup>	1 – 10 MHz
Pulse repetition rate after pulse picker	PRR = PRR <sub>L</sub> / N, N=1, 2, 3, ... , min 10 kHz
External pulse gating	via TTL input
Burst mode <sup>6)</sup>	1 – 10 pulses
Max burst energy	
at 1030 nm	> 10 μJ
at 515 nm	> 5 μJ
Burst shape control	via analog input
Power attenuation	0 – 100 % from remote control application or via analog input
Polarization orientation	linear, vertical
Polarization extinction ratio	>1000:1
M <sup>2</sup>	< 1.2
Beam divergence (full angle)	<1.0 mrad
Beam circularity (far field)	> 0.85
Beam pointing stability (pk-to-pk) <sup>7)</sup>	< 30 μrad
Beam diameter (1/e <sup>2</sup> ) at 20 cm distance from laser aperture	
at 1030 nm	2.0 ± 0.3 mm
at 515 nm	1.0 ± 0.2 mm
<b>OPERATING REQUIREMENTS</b>	
Mains requirements	100–240 V AC, single phase 47–63 Hz
Maximal power consumption	< 500 W
Operating ambient temperature	15 – 30 °C
Relative humidity	10 – 80 % (non-condensing)
Air contamination level	ISO 9 (room air) or better
<b>PHYSICAL CHARACTERISTICS</b>	
Cooling of the laser head	air, passive
Laser head size (L×W×H)	
at 1030 ± 2 nm	464 × 363 × 129 mm
at 515 ± 1 nm	620 × 363 × 129 mm
Power supply unit size (L×W×H)	449 × 436 × 140 mm (stand-alone) or 483 × 436 × 140 mm (19" rack mountable)
Umbilical length	5 m
<b>CLASSIFICATION</b>	
Classification according EN60825-1	CLASS 4 laser product

<sup>1)</sup> Due to continuous improvement, all specifications are subject to change without notice. Parameters marked typical are not specifications. They are indications of typical performance and will vary with each unit we manufacture.

<sup>2)</sup> See typical power and energy curves for other pulse repetition rates at Fig 1., Fig 2. and Fig 4.

<sup>3)</sup> At 1 MHz PRR, during 24 h of operation after warm-up under constant environmental conditions.

<sup>4)</sup> At 1 MHz PRR<sub>L</sub> under constant environmental conditions.

<sup>5)</sup> When pulse picker is set to transmit every pulse.

<sup>6)</sup> Pulse separation inside the burst is about 20 ns.

<sup>7)</sup> Beam pointing stability is evaluated as a movement of the beam centroid in the focal plane of a focusing element.



PERFORMANCE

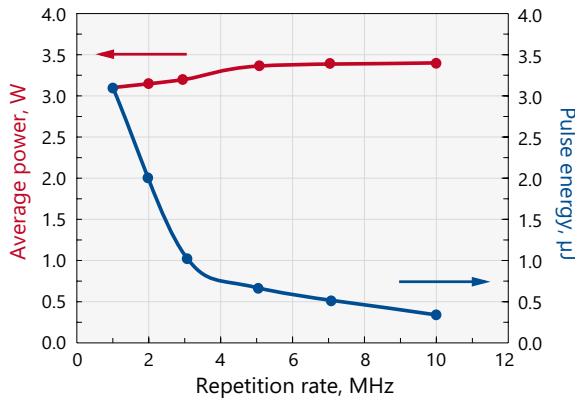

Fig 1. Typical dependence of output power and pulse energy of FemtoLux 3 laser at 1030 nm when changing internal repetition rate of the laser

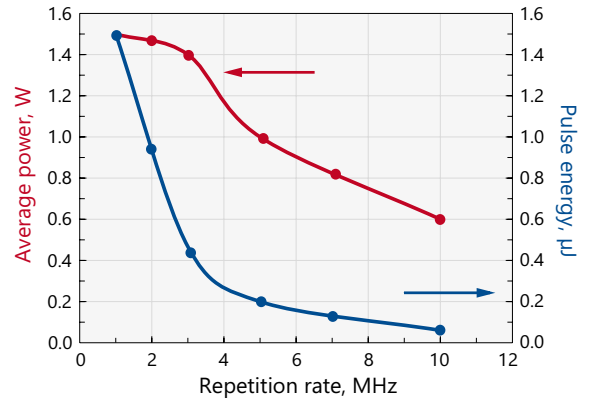

Fig 2. Typical dependence of output power and pulse energy of FemtoLux 3 laser at 515 nm on pulse repetition rate

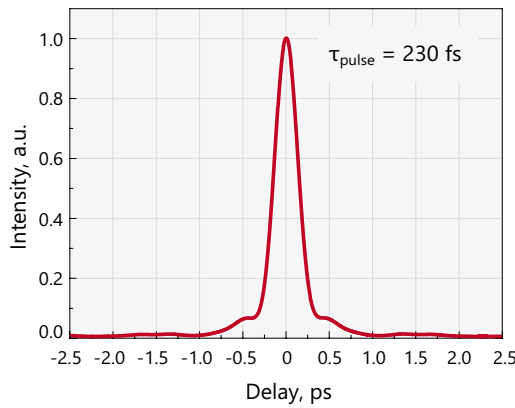

Fig 3. Typical FemtoLux 3 laser (at 1030 nm) output pulse autocorrelation function at 3 μJ pulse energy. Calculated pulse duration is 230 fs

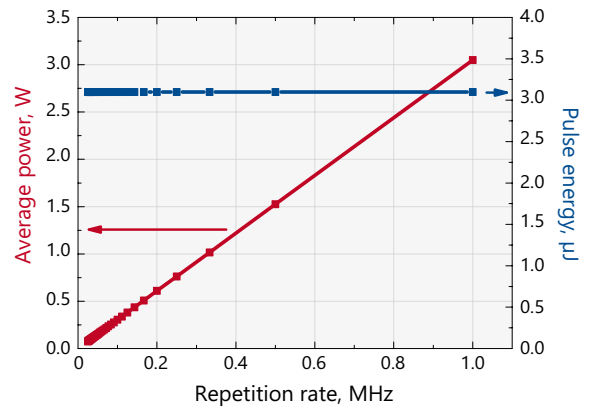

Fig 4. Typical dependence of output power and pulse energy of FemtoLux 3 laser at 1030 nm when repetition rate is reduced by pulse picker. Internal repetition rate of the laser in this case is 1 MHz

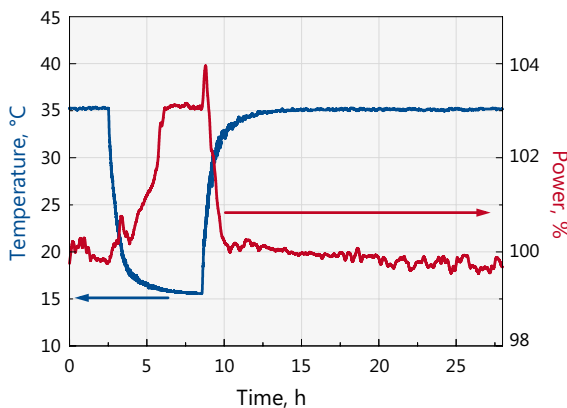

Fig 5. Average output power dependence on ambient temperature at 1030 nm

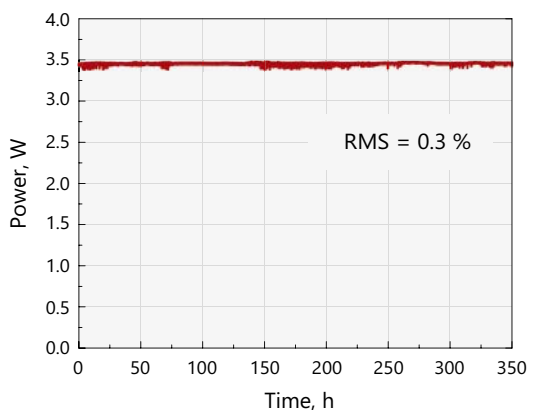

Fig 6. Typical long term average output power stability of FemtoLux 3 laser at 1030 nm under constant environmental conditions

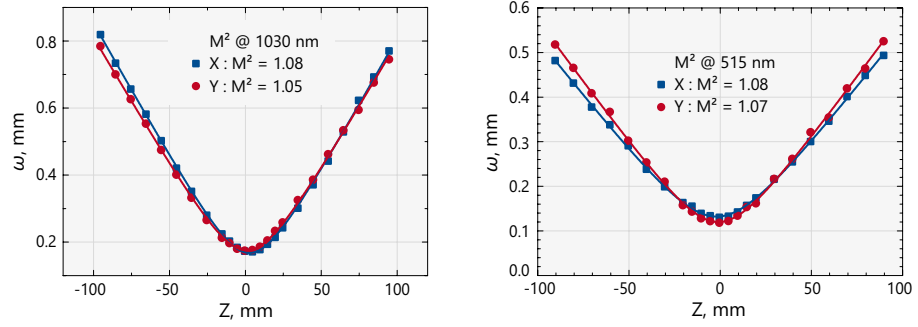

Fig 7. Typical M<sup>2</sup> measurement of FemtoLux 3 laser

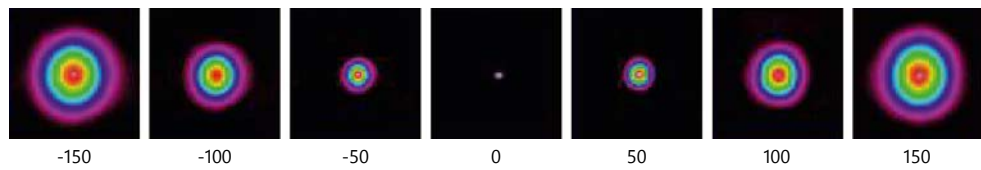

Fig 8. Typical beam profiles along propagation axis of FemtoLux 3 series laser

REMOTE CONTROL APPLICATION

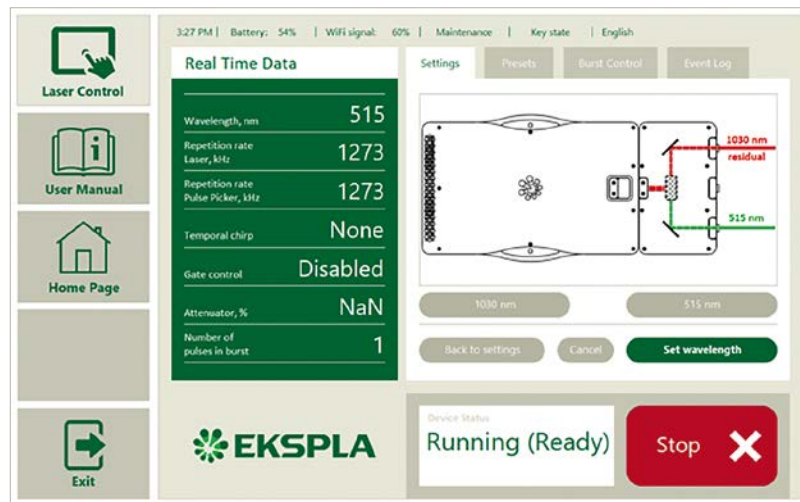

Fig 9. Example of FemtoLux 3 remote control application

DRAWINGS

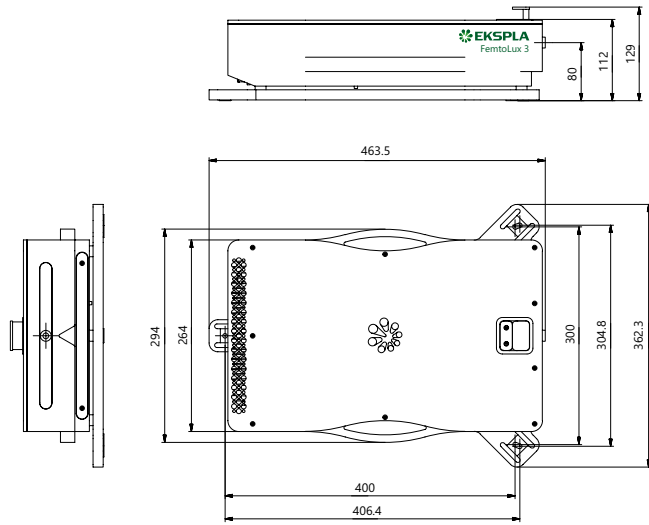

Fig 11. Outline drawings of FemtoLux 3 laser head

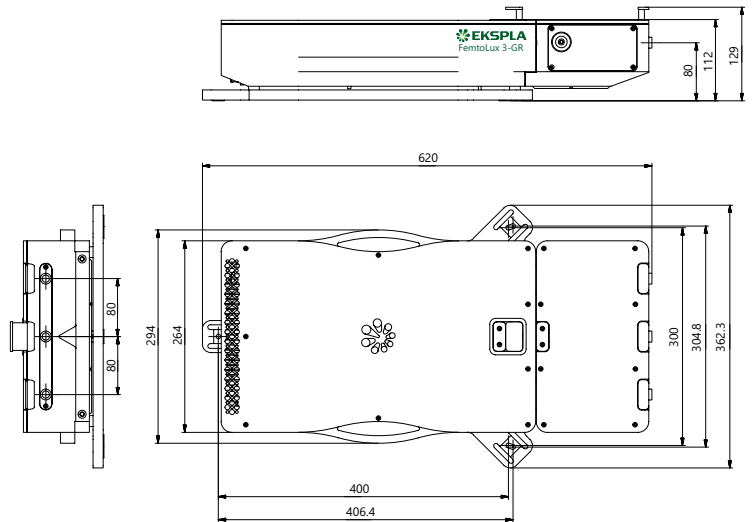

Fig 12. Outline drawings of FemtoLux 3 laser head with second harmonic option

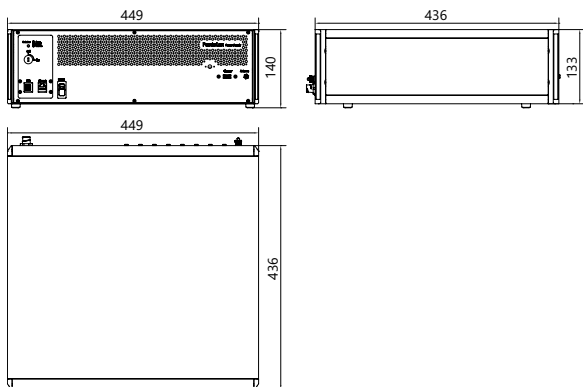

Fig 13. Outline drawings of FemtoLux 3 stand-alone control unit

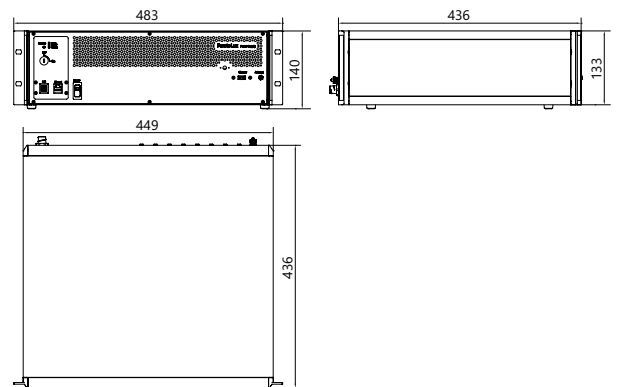

Fig 14. Outline drawings of FemtoLux 3 19" rack mountable control unit